

Process Design and Simulation of Sulphuric Acid Plant



By

Muhammad Ahmad Anwar

00000132685

Muhammad Faizan Ahmed

00000122969

Muneeb Zulfiqar

00000127557

School of Chemical and Materials Engineering (SCME)

National University of Science and Technology (NUST)

2019

Process Design and Simulation of Sulphuric Acid Plant



Submitted By:

Muhammad Ahmad Anwar

00000132685

Muhammad Faizan Ahmed

00000122969

Muneeb Zulfiqar

00000127557

**This report is submitted as a FYP thesis in partial fulfilment of the
requirement for the degree of
BE Chemical Engineering**

Supervisor: Dr. Iftikhar Salarzai

Industrial Supervisor: Engr. Fahad

School of Chemical and Materials Engineering (SCME)

National University of Science and Technology (NUST)

May 2019

Certificate

This is to certify that the work in this thesis has been carried out by **Mr. Muhammad Ahmad Anwar, Mr. Muhammad Faizan Ahmed and Mr. Muneeb Zulfiqar** and completed under supervision of **Dr. Iftikhar Salarzai** in School of Chemical and Materials Engineering (SCME), National University of Sciences and Technology (NUST), H-12, Islamabad, Pakistan.

Supervisor: _____

Dr. Iftikhar Salarzai

Chemical Engineering Department

School of Chemical & Materials Engineering (SCME)

National University of Sciences and Technology (NUST), Islamabad

Submitted through:

HoD

Dr. Bilal Khan Niazi

Chemical Engineering Department

School of Chemical & Materials

Engineering

National University of Sciences

and Technology, Islamabad

Principal/ Dean

Dr. Arshad Hussain

School of Chemical & Materials Engineering

National University of Sciences

and Technology, Islamabad

Dedication

From the grace of Allah, this piece of work is dedicated to our teachers and parents, who were a source of constant support and have helped us in becoming the people we are today.

Acknowledgements

Thanks to **Almighty Allah** for His countless blessings, He gave us courage to finish this project. A very special recognition to our Supervisor, **Dr. Iftikhar Salarzai** for supervising this project and for his support us throughout the year. Because of his experience and knowledge, we are able to complete this project. We express our profound gratitude to **Mr. Fahad** from **International Petro-Chemicals (IPC)** for giving us this project and believing in us. Furthermore, we extend our gratitude to him for his continual provision and guidance. He has been an immense source of assistance. We couldn't have completed all the necessary paperwork and delivered it properly without him. We are able to achieve this milestone due to love and prayers of our beloved **parents**.

Abstract:

Sulphuric acid is an important chemical produced through Contact Process all over the world. Our study presents the steady state model, simulation for an industrial sulfuric acid plant. The model, implemented in Aspen-HYSYS includes a catalytic reactor (four pass converter), heat exchangers, mixers, splitters and reactive absorption columns. In a single integrated environment, Aspen HYSYS V8.8 was used successfully for the design of all sulfuric acid subprocesses. Real plant data and theoretical data for maximum percent SO₂ oxidized material and energy streams agree very well with the simulation results, sized unit operations can be used to perform an economic assessment of each process. The developed simulation model can also be used as a guidance on process and economic understanding and a basis on which more sophisticated plant design and process equipment design models can be specified. Before Simulation, each of the important equipment has been designed i.e. Reactor, Absorber and heat exchanger. Following the equipment design, extensive economic analysis has been carried out to estimate the cost and payback period of a Sulphuric acid plant. One of the main objective of the project is to carry out a sensitivity analysis. It has been carried out using a MATLAB code to extract data from excel sheet and apply it in Aspen HYSYS. Process Control has been described using a temperature controller and a flow controller on reactor and heat exchanger. HAZOP Analysis on reactor and absorber has also been completed and demonstrated.

Table of Contents

Chapter 1: Introduction	10
1.1 Background	11
1.2 Objective	13
Chapter 2: Literature Review	14
2.1 Overview of Sulphuric Acid Plant	14
2.2 Commercial Grade Sulphuric Acid Production Process	14
2.3 Sulphur Burning	14
2.4 Conversion of SO ₂ to SO ₃	15
2.5 Catalyst Temperature Limitations.....	17
2.6 Absorption of SO ₃	18
2.6 Gas Cleaning Systems.....	18
2.7 Tail Gas Scrubber.....	18
2.8 Equipments used in Contact Process.....	19
2.8.1 Drying Tower.....	19
2.8.2 Burner	19
2.8.3 Heat Exchanger.....	19
2.8.4 Reactor	19
2.8.5 Absorber.....	19
2.8.6 Coolers	20
2.8.7 Mixing Tees	20
2.9 Usage of Sulphuric Acid	20
2.9.1 Fertilizer.....	20
2.9.2 Processing of Metal Ores	20
2.9.3 Industrial Usage	21
2.9.4 Electrolyte in batteries	21
2.10 Environmental Issues	21
2.11 Aspen ONE Engineering for Sulfuric Acid Plant	22
2.11.1 Limitations of Aspen- HYSYS in simulation of Sulfuric acid plant	22
Chapter 3: Material and Energy Balance	24
3.1 Material Balance	24
3.2 Material Balance on all equipments.....	25
3.3 Alternative Approach.....	30
3.3 ENERGY BALANCE.....	31
3.4 Energy Balance on all the Equipments	32

Chapter 4: Equipment Design	38
4.1 Reactor Design	38
4.2 Absorber Design.....	42
4.3 Heat Exchanger Design.....	46
Chapter 5: ECONOMIC ANALYSIS	51
5.1 Equipment Cost.....	51
5.2 Physical Plant Cost.....	55
5.3 Fixed & Working Capital.....	55
5.4 Variable cost.....	57
5.5 Fixed Cost	58
5.6 Payback Period.....	59
Chapter 6: Simulation	60
6.1 Simulation of Aspen HYSYS Model	60
6.2 Reactions	62
6.3 Unit Operation Models	66
Chapter 7: Sensitivity Analysis	72
7.1 Introduction	72
7.2 MATLAB Code.....	73
7.3 Results	74
Chapter 8: Process Control	79
8.1 Introduction	79
8.2 General Explanation.....	80
Chapter 9: HAZOP Analysis	81
Chapter 10: Conclusion	86
Chapter 11: References	87

List of Figures

Figure 1 Regional Sulphuric Acid Production	11
Figure 2 Producer Price Index Industry Data	11
Figure 3 Contact Process	12
Figure 4 Equilibrium temperature vs conversion	16
Figure 5 Sulphuric Acid Usage	21
Figure 6 Process Flow Diagram	23
Figure 7 Simulation	60
Figure 8 Fluid Package Aspen HYSYS	62
Figure 9 Reactions Aspen HYSYS	64
Figure 10 Drying Tower Aspen HYSYS	66
Figure 11 Furnace Aspen HYSYS	67
Figure 12 Heat Exchanger Aspen HYSYS	68
Figure 13 Plug Flow Reactor Aspen HYSYS	69
Figure 14 Primary Absorber Aspen HYSYS	70
Figure 15 Secondary Absorber Aspen HYSYS	71
Figure 16 Effect of Air Flow rate on Sulphuric Acid Composition	74
Figure 17 Effect of sulphur composition on Sulphuric acid flow rate	75
Figure 18 Effect of Absorber temperature on Sulphuric Acid Composition	75
Figure 19 Effect of temperature on Reactor Conversion	76
Figure 20 Effect of Air temperature on Sulphuric acid composition	77
Figure 21 Effect of Reactor Pressure on Sulphuric Acid Composition	77
Figure 22 Effect of sulphur flow rate on sulphuric acid composition	78
Figure 23 Process Control Reactor	79
Figure 24 Process Control Heat Exchanger	80

List of Tables

Table 1 Material Balance on Drying Tower	25
Table 2 Material Balance on Furnace	26
Table 3 Material Balance on 1st Conversion Reactor	26
Table 4 Material Balance on 2nd Conversion Reactor	27
Table 5 Material Balance on 3rd Conversion Reactor	27
Table 6 Material Balance on 4th Conversion Reactor	28
Table 7 Material Balance on Primary Absorber	29
Table 8 Material Balance on Secondary Absorber	29
Table 9 Plug Flow Reactor	30
Table 10 Energy Balance on Drying Tower	32
Table 11 Energy Balance on Furnace	33
Table 12 Energy Balance on Heat Exchanger	33
Table 13 Energy Balance on 1st Conversion Reactor	34
Table 14 Energy Balance on 2nd Conversion Reactor	35
Table 15 Energy Balance on 3rd Conversion Reactor	35
Table 16 Energy Balance on 4th Conversion Reactor	36
Table 17 Energy Balance on Primary Absorber	37
Table 18 Energy Balance on Secondary Absorber	37
Table 19 Parameters of saddles	45
Table 20 Physical Plant Cost	55
Table 21 Fixed & Working Capital	55
Table 22 Variable cost	57
Table 23 Fixed Cost	58
Table 24 Components in Aspen HYSYS	61
Table 25 HAZOP Analysis on Absorber	82
Table 26 HAZOP Analysis on Reactor	83

Chapter 1: Introduction

1.1 Background

Sulfuric acid is an odorless, colorless hygroscopic liquid that has a corrosive nature (depending on the level of acidity) and also holds the title of “King of Chemicals” due to its vast use in the chemical industry on commercial and domestic scale. Sulfuric acid is the most widely produced industrial chemical in the world and utilization of sulfuric acid is frequently used to scale a nation's level of industrialization. Every year, sulfuric acid is being produced industrially in greater quantity as compared to all the other chemicals. Currently, the world-wide production exceeds 170 million of tones, with Asia as USA as the top consumers (Fig. 1).

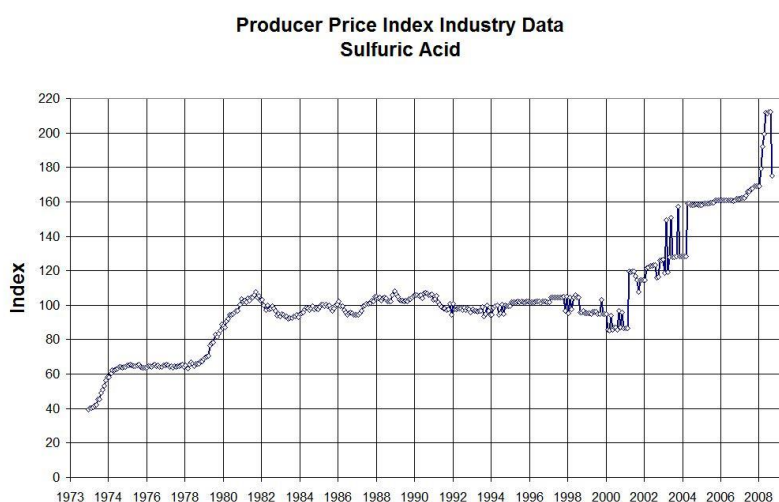

Figure 2 Producer Price Index Industry Data

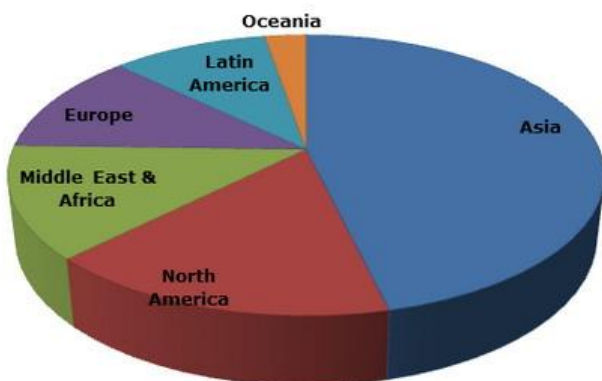

Figure 1 Regional Sulphuric Acid

measure of sulfuric-corrosive. Likewise, sulfuric acid market is expanding its interest because of mechanical cleaning operators as sulfuric acid is additionally used as cleaning specialist and

Sulfuric acid is a particularly toxic and corrosive acid, with extreme environmental and health hazards if not fabricated, utilized, and directed properly. Sulfuric acid has a wide range of uses including: explosives, drugs, paints, food containers, wood preservatives, soaps and detergents, pharmaceutical products, petroleum products, pulp and paper phosphate fertilizer production, dyes, alcohols, plastics, rubber, ether, glue, film. One of the major uses of H₂SO₄ is its use in the automotive industry. Batteries used in car industry contains extensive

channel cleaner, the interest for sulfuric acid is expanding at yearly development rate of over roughly 6.5%. In chemical industry, Sulfuric acid is being used broadly as a solvent for ores and as catalyst for polymer manufacture and petroleum refining. Agricultural fertilizers signify the biggest consumers of the sulfuric acid, accounting for up to 65% of its usage.

It is advantageous to set up the sulfuric acid industry near the product acid's point of use—i.e. near phosphate fertilizer plants, petroleum refineries etc. since, elemental sulfur is easier and cheaper to transport than sulfuric acid. Note likewise, that the irregularity of the sulfuric acid cost is because of the little uneven characters between acid's interest and supply, just as the trouble of putting away vast amounts of acid. The recent large increase in price is due to increasing demand for fertilizer, hence sulfuric acid. There is a need in the market to produce high value products at lower costs. Technology is fundamental to the profitable design and operation of environmentally friendly sulfuric acid plants and processes.

Let's talk about the methods through which the sulfuric acid was produced initially on an industrial scale versus the modern methods and techniques. The main two methods for the production of sulfuric acid on a commercial scale are as follows;

- I. Lead Chamber process
- II. Contact process

Following is the process to produce sulfuric acid through contact process

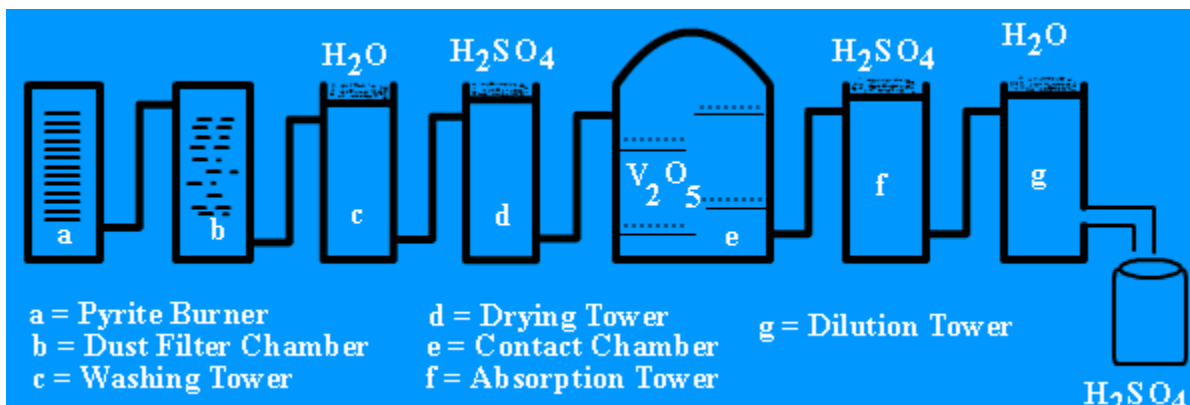

Figure 3 Contact Process

Initially, sulfuric acid was produced industrially through the lead chamber process. In lead chamber process, SO_2 is offered with steam and NO_2 into reaction chambers fixed with sheet lead where the gases are splashed down with water and chamber acid (62– 70% Sulfuric corrosive). The, SO_2 and NO_2 disintegrate and it takes roughly 30 minutes for the sulfur dioxide to oxidize to sulfuric acid. The presence of nitrogen dioxide is fundamental for the response to continue at a sensible rate. The procedure is very exothermic, and a noteworthy thought of the plan of the

chambers was to give an approach to disperse the heat released in the process. However, lead chamber process was discarded and replaced by a better and more efficient process that is the “Contact Process”. Lead chamber process was in-efficient because it requires high electricity and continuous supply of the air, it generates solid particles which requires the sludge removal, the product could be poisoned due to the leakages of lead ions into the acid stream. One of the major bottleneck of this process was that it could only produce sulfuric acid with a concentration of 70-78%. For higher concentrations, the distillation was to be repeated again and again which was not feasible.

On the other hand, contact process is more efficient, environment friendly, does not produce any environmental hazards unlike toxic chemicals in lead chamber process. Through this process we can achieve sulfuric acid with a high concentration of 98.5%. The catalyst used is vanadium pentoxide V_2O_5 . Although the catalyst is a bit expensive, it proves its worth by covering a life span of 4-5 years.

1.2 Objective

The motivation behind this project was to inspect how modeling technology can help in debottlenecking existing plants, achieving high product purity, making it energy efficient, and automate process analysis to optimize plant operations. A simulation model of the contact process Sulfuric acid plant along with proper catalytic bed distribution in converter was proposed and developed in Aspen-HYSYS. Different parameters influencing converter performance was observed. A detailed sensitivity analysis was performed using three software's i.e. MATLAB, Aspen HYSYS and Microsoft Excel to determine the optimum conditions for the process and also the factors that most effectively influence the production of our final product (sulfuric acid). Intercept temperature for maximum SO_2 oxidation for each bed was determined and further used in the model. Sulfuric acid plants are net producers of steam; so, it was also determined how effective decisions on steam boilers (exchangers) can be made using sulfuric acid plant models. For this purpose, we performed major equipment designs including the reactor, absorber and heat exchangers, and also the HAZOP analysis and the cost analysis of the whole plant. Moreover, current legislation imposes tighter restrictions to reduce the impact of chemical process industry on the environment. The proposed model implemented in Aspen-HYSYS is useful for evaluating the static behavior of the plant and for minimization of the total amount of SO_x emissions. The simulation model was also compared with existing plant with same operating condition to verify the acceptability of the model.

Chapter 2: Literature Review

2.1 Overview of Sulphuric Acid Plant

Sulphuric acid is the most produced chemical compound in the world. In 2011, about 168 million tons of about 10 billion USD, were the annual Sulphuric acid production.

Any concentration of Sulphuric acid in water is soluble. Different methods produced sulphuric acid, but the contact process is most important.

The lead chamber process for the sulphuric acid production was initiated during the 1700's and used until 1831 during the introduction of the contact process. Due to the high purity of sulphuric acid produced by this process, industries have shifted their plants towards contact process.

It is observed that both processes are performed quickly and continuously in industrial applications.

The reasons behind these process steps were explained, acid control and optimization were considered. SO₂ (g) oxidation efficiency and its impact on the composition of feed gas, feed gas temperature, catalyst composition, catalyst bed pressures, number of catalyst beds, and double versus single contact acid production are highlighted. A review of several other SO₂-carrying gas treatment methods is also included.

2.2 Commercial Grade Sulphuric Acid Production Process

A plant that produces sulphuric acid from sulphur as a raw material has following main sections:

- Sulphur feed
- Waste heat recovery
- Conversion of SO₂
- Acid towers
- Acid Storage handling
- Plant infrastructure (electrical/civil/water treatment, etc.)

2.3 Sulphur Burning

Solid sulphur is introduced on the melter's grids and melted by heat supplied by steam rolls in the melter. The sulphur is fastly fused by an agitator installed into the melter. The liquified sulphur is

then pumped into the pressurized sulphur filter and placed in an independent cabinet with steam coils. Sulphur pumps are used for the predetermined constant feeding of fluid sulphur into the sulphur burner. A previous oil firing preheats sulphur burner to a high temperature and therefore instantly ignites the sulphur that produces sulphur dioxide. A drying tower contains blower with which the dry air is supplied as a raw material to the furnace.

The combustion gases are 950–1000 degrees Celsius and contain 10.0–10.5 per cent sulphur dioxide. They pass a waste heat recovery heater to produce a high-pressure steam while gases are cooled down to between 390 and 410 ° C, according to the design of the plant and the layout of the gas duct.

The cooled gasses now go through a multi-stage conversion system (four or five phases) (the first converter has three passes and the second one/ two passes).

2.4 Conversion of SO₂ to SO₃

This is main process taking place to produce sulphuric acid. It's a catalytic gas phase equilibrium reaction:



The conversion of SO₂ to SO₃ reaction can be found by:

$$\text{Conversion achieved} = \frac{\text{SO}_2 \text{ in} - \text{SO}_2 \text{ out}}{\text{SO}_2 \text{ in}} * 100$$

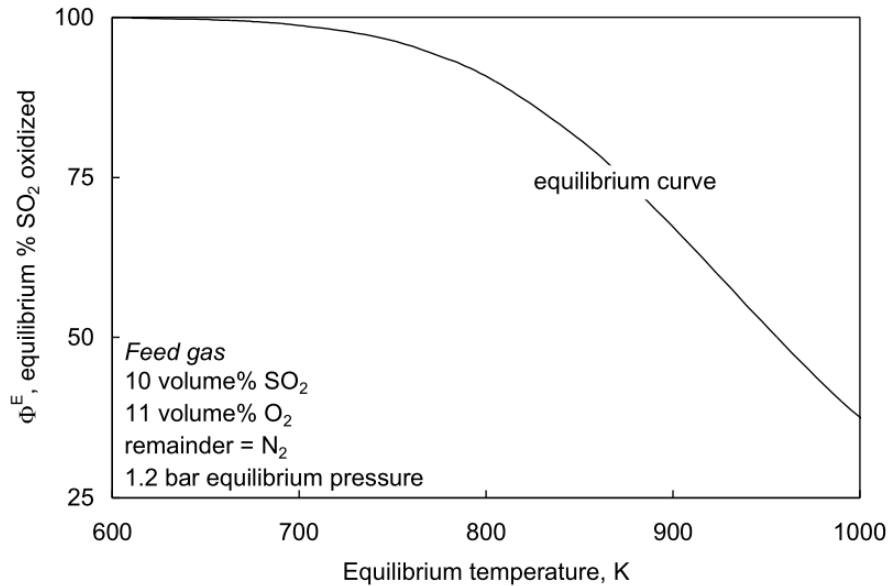

Figure 4 Equilibrium temperature vs conversion

The maximization of formation of SO₃ takes account of both the thermodynamic and the stoichiometric considerations. In deciding how to optimize the balance, the Le Chatelier's-Braun principle is usually taken into account. It says that the system tends to adjust itself to relieve a part of the stress when a balance system is subjected to stress. For example, these stresses include changes in temperature, pressure or reactor concentration.

The following approaches to maximize SO₃ formation for SO₂/SO₃ systems are available:

- Removal of thermal energy-
the reduction of temperature promotes the development of SO₃, because it is an exothermic process
- Enhancing the oxygen concentration at the inlet
- Removal of SO₃ (dual contact dual absorption) from the reaction area
- Enhanced system inlet pressure
- Optimization of process temperature by selecting suitable catalyst
- Increased reaction time

The optimal complete conversion of SO₂ in the system requires a balance of forward and reverse response velocity (equilibrium achieved). This optimum, however, depends on the raw gas SO₂

concentration and on its time variability. Consequently, for a particular SO₂ source, each method is more or less specific.

The classic vanadium pentoxide systems have a cesium-friendly ring type, both in the first and last (fourth / fifth), and in the other two / three passes. A second waste heat boiler is supplied after the first catalyst pass to recover additional heat. The customer can supply a vapor superheater in the waste heat recovery system to export vapor to nearby manufactory or to generate superheated steam for captive use. Gasses of the second catalyst pass the Hot Heat Exchanger (HHE) before entering the third catalyst pass. Cold Heat Exchanger (CHE) and then an economizer passes through the gasses of the 3rd pass outlet. It comes next and absorbs all the sulphur trioxide produced by the converter's first three passes. High efficiency candle type demisters are used to remove the acid mist generated in the tower to protect the catalyst in the afterward passes. The design of the gas piping layout provides for the economizer to be either in service or to be commissioned.

At the end of the fourth pass a dry air injection plant is sometimes provided for cooling the gasses before the fifth pass reaches about 380–390 ° C. This is done in order to maximize the overall transformation from SO₂ to SO₃ because the last pass can be operated at the lowest possible temperature.

Before entering the final absorption tower, the gasses from the fifth pass are transported via another economizer for pre-heating boiler feed water. DT (Drying Tower), IPAT (Inter Pass Absorption Tower), and FAT (Final Absorption Tower) circulating sulphuric acid are refrozen by the passage through the plate heat exchanger where heat and the refrigerant water are exchanged. A sufficient size cooling tower lowers the temperature of water.

2.5 Catalyst Temperature Limitations

The elements V, K, Na, Cs, S, O catalyst work for a reaction when they are molten. It melts around 410⁰C, slightly lower when there are cesium ions. When the temperature rises till 630⁰C the activity of the catalyst starts losing due to the formation of non-reactive vanadate ions and by non-reversible reaction with silica substrate. So, the SO₂ oxidation should be optimum in between 450-500⁰C.

2.6 Absorption of SO₃

Appropriate amounts of water are added to preserve the concentration of the hot sulphuric acid absorbed into H₂SO₄ (with an optimal concentration of at least 98 percent). The absorption efficiency depends on the following:

- concentration of H₂SO₄ in absorbing liquid (98.3–98.7%)
- liquid temperature range (normally 70 °C–120 °C)
- Plate Heat Exchanger (PHEs) used for removing heat of absorption for sulphuric acid coolers
- Its difficult to absorb acid mist particles so moisture content is removed from raw gas
- Sulphuric acid mist is removed by mist arrestor
- Entering gases temperature

Emission of SO₃ from plant depends upon:

- Final absorber construction
- The presence of water vapor forming acid mist at the upstream of absorber.
- H₂SO₄ aerosol separator

The strength of the absorbing acid is kept automatically at the optimal position on the strength controller in modern plants. The addition of dilution water is checked.

2.6 Gas Cleaning Systems

The gas cleansers of the metal sulphuric acid plant have four main tasks:

- SATURATION of gases and ELIMINATION of fine and coarsely particulate matter, and
- COOLING of metal fumes and humidity removal;
- ELECTROSTATIC PRECIPITATION for removal of very fine particles and the bulk of acid mist;
- Specific gas impurity removal processes (e.g. removal of mercury, halogens)

2.7 Tail Gas Scrubber

During plant start-up a two-stage alkaline scrubber is used to cater for disturbed process conditions after a long stop. Alkali levels are maintained automatically in the scrubbing liquor.

In the continuous operation of the plant, the scrubber will not be required if a catalyst promoted by cesium is used in the last pass of the transformer at sufficient amounts and operates at 385 to 390 ° C.

2.8 Equipments used in Contact Process

2.8.1 Drying Tower

It is the first equipment in the process which is used to remove the water from the air because dry air is required to produce SO₂.

2.8.2 Burner

It is the first equipment present in the contact process. Molten sulphur is reacted with air in the burner to produce SO₂ gas for the further process. The SO₂ produced here depends upon the flow rates of air and molten sulphur entering it.

2.8.3 Heat Exchanger

It is the temperature regulating equipment in the process after the burning of sulphur in furnace the temperature raises to above 1200⁰C which is to be lowered to 450⁰C because it is the optimum temperature at which the reaction will take place. In this process shell and tube heat exchanger is used in which SO₂ gas is in the tubes and water is in the shell side.

2.8.4 Reactor

In any process reactor is the main equipment. The reactor used in the process is packed bed reactor. There are four beds of Vanadium Pentoxide (V₂O₅) catalyst. The operating pressure of the reactor is 1-2 bar and the temperature range are 450-500⁰C. in reactor SO₂ is being converted into SO₃.

2.8.5 Absorber

In absorbers the SO₃ is being absorbed in water to produce sulphuric acid. Two absorbers are added to the plant to achieve required 98.5% purity of sulphuric acid.

2.8.6 Coolers

Coolers are used where temperature of the feed are required to be lowered.

2.8.7 Mixing Tees

At several place mixing tees are used to mix pure sulphuric acid with water to make it 98-98.5% pure.

2.9 Usage of Sulphuric Acid

2.9.1 Fertilizer

Globally, the quality and yield of fruits and vegetables in fertilizers are increased by three primary nutritional products: nitrogen, phosphorus and potassium. Some fertilizers, including mono-ammonium phosphate (MAP) and di-ammonium phosphate (DAP) two-component fertilizers, offer farmers an effective way to supply soils with nitrogen as well as phosphorus. The production of both MAP and DAP, mixed with phosphate rock to produce phosphoric acid, takes sulphuric acid as a first important step. Since the energy consumption of the phosphorous acid process is a critical part of the fertilizer process, a sulphuric acid plant – a net generator of energy – on the site. 70% world wide manufacture of superphosphate fertilizers involves the use of sulphuric acid.

2.9.2 Processing of Metal Ores

In the production of copper and in the production of zinc, the surface, known as "pickling," is widely used in metal processing and in the cleaning before it is covered into a thin layer of tin for the production of food canned cans.

The solvent sulphuric acid is used to leach the desired metals from the earth's ores. In uranium mining and for zinc and nickel ores sulphuric acid leaching is used.

2.9.3 Industrial Usage

Industrially sulphuric acid is the most used chemical compound that is used to make or in the processing of other useful products.

It is currently being used in:

- Processing on paper pulp
- To make caprolactam which is converted in polyamide 6
- Manufacturing of titanium dioxide used as a pigment
- Manufacturing of hydrofluoric acid, phenol and propanone
- Manufacturing of detergents

2.9.4 Electrolyte in batteries

Sulphuric acid is widely used in motor batteries as an electrolyte since sulphuric acid supplied ion is required for the recharge and discharge of lead acid batteries. Sulphuric acid is cheap, so it is the best way to get this ion.

2.10 Environmental Issues

Several toxic gasses are generated during the production of sulphuric acid. SO₂ is one of the most hazardous gas. It's a toxic gas that smells like a burnt gas. Sulphur dioxide is a major pollutant of the air and has major health effects. Moreover, the sulphur dioxide concentration in the atmosphere can affect the suitability of the habitat for plant and animal communities.

Sulphur dioxide inhalation is linked to increased respiratory symptoms and disease, respiratory difficulties and premature death. The limit to 0.25 parts per million (ppm) is short-term exposure.

Existing heart and lung conditions may also be exacerbated by longer exposures. In addition to health effects, sulphur dioxide and other SO_x are partly attributable to thick haze and smog.

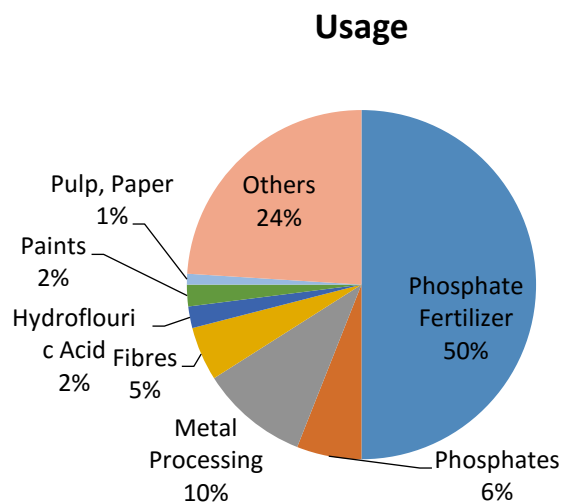

Figure 5 Sulphuric Acid Usage

In addition to the effects on human health, the contribution of sulphur dioxide to acid rain can cause direct damage to trees and plants by damaging exposed tissue and consequently decreasing the growth of plants. Acid rain also affects other sensitive ecosystems and waterways.

2.11 Aspen ONE Engineering for Sulfuric Acid Plant

Aspen ONE Engineering provides engineers with Aspen HYSYS to prepare simulated models of plants to check the validity of plants and make the changes that will economize, maximize yield and efficiency and reduce capital cost generating more profits. It has been used by plant owners, companies and technology providers. Simulated model of sulphuric acid plant can also be made on Aspen HYSYS. It is challenging because the cost of maintenance and operation of this plant is very high, minimization of SO₂ emissions, energy economization, and accurate equipment size is to be kept in mind.

Aspen ONE provides the world's largest data base of pure components, compounds, and phase equilibrium data for conventional chemicals, electrolytes, solids and polymers. The physical and thermal properties in the data base are updated time to time with the reference data from U.S National Institute of Standards and Technology (NIST). High accuracy of the data is required because the physical properties data is critical for developing a simulated model of any plant in Aspen HYSYS. It directly affects the cost and other perspectives of the plant.

The enabling of electrolyte feature in Aspen HYSYS is another plus point that improves the accuracy of the calculations done in vapor-liquid phases in the adsorption units in sulphuric acid plant.

Sulphuric acid simulation model was made to do parametric study to analyze the effect of process variables on the production of sulphuric acid.

2.11.1 Limitations of Aspen- HYSYS in simulation of Sulfuric acid plant

Aspen HYSYS provides some ease to the engineers whereas there are some limitations that are to be tackled when designing a simulation of sulphuric acid plant on Aspen HYSYS. First and the most important the catalytic bed reactor used in industry is a single reactor that is not present in the Aspen HYSYS. Not even similar reactor is not present so either one has to use PFR or conversion reactors equal to the no of beds in the catalytic reactor being used in the industry. Another limitation is the choice of the reaction kinetics concerning the built-in expression and its

required parameters. Another equipment that is not available in the HYSYS is reactive absorption column.

Tentative Process Flow Diagram

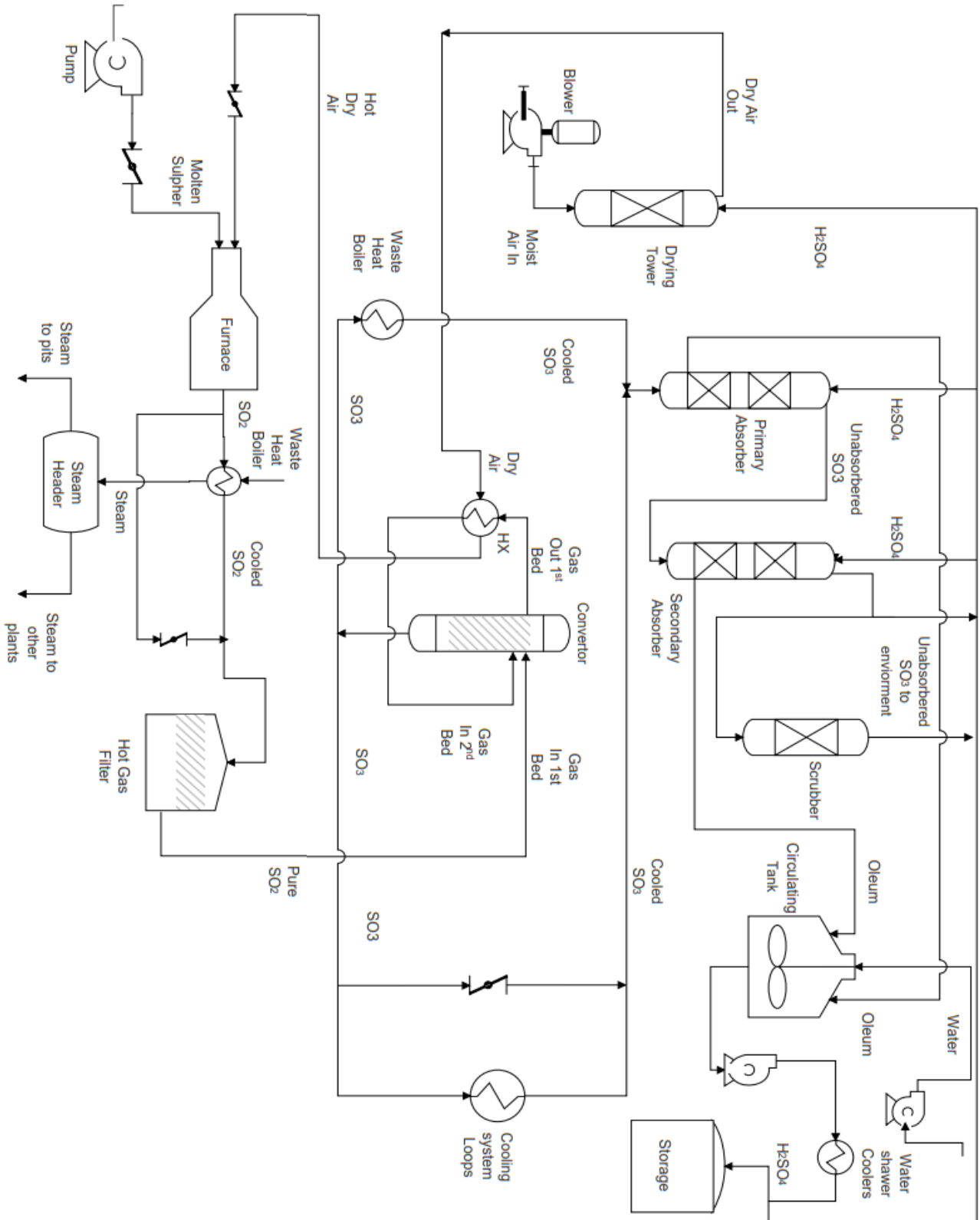

Figure 5 Process Flow Diagram

Chapter 3: Material and Energy Balance

3.1 Material Balance

- Material Balance is based on the law of conservation of mass (what goes in, comes out).
- It is calculated using the inventory rate equation

$$\text{Mass Flow In} - \text{Mass Flow Out} + \text{Mass Generated} = \text{Mass Accumulated}$$

Sulphuric Acid Manufacturing Process

- **Continuous Process (No Accumulation)**
- **No Generation**

Thus, the inventory rate equation reduces to
Mass Flow In = Mass Flow Out

Basis	Flow	Units
1 hour	Mass	lb/hr

- 98-98.5 wt.% Sulphuric acid is to be produced.
- Plant is designed to produce approximately 130 tons/day of Sulphuric acid.
- Molten Sulphur Feed: 27000 lb/hr
- Moist Air: 224000 lb/hr
- Each Pass Conversions

1 st Pass:	63%
2 nd Pass:	84%
3 rd Pass:	93%
4 th Pass:	99.5%

3.2 Material Balance on all equipments

1) Drying Tower

Moist air is being dried using sulphuric acid which is being recycled as part of the product stream. Moisture is being removed and dry air goes to the furnace to react with sulphur. Sulphuric acid attracts moisture and takes away the moisture with it.

Table 1 Material Balance on Drying Tower

Drying Tower				
Components	Moist Air	H₂SO₄ In	Dry Air	H₂SO₄ Out
H ₂ SO ₄	0	853.1817	0	852.9729
H ₂ O	5622.9072	11	5485.55	142.147
N ₂	167605.266	0.0579	167633.93	0.0158
O ₂	50771.8271	0.006	50780.52	0.0128
SO ₂	0	0	0	0
S	0	0	0	0
SO ₃	0	5.7934	0	0.014
Total (lb/hr)	224000	870	223900	995.1

2) Furnace

Dry air from drying tower enters the furnace and reacts with sulphur to form sulphur dioxide with 100% conversion. Following reaction takes place in the furnace.



Table 2 Material Balance on Furnace

Furnace (Reactor)			
Components	Molten S	Dry Air	SO2
H ₂ SO ₄	0	0	0
H ₂ O	0	5485.55	5492.739
N ₂	0	167633.9	167616.323
O ₂	0	50780.52	23927.274
SO ₂	0	0	53748.583
S	26910	0	0
SO ₃	0	0	0
Total (lb/hr)	26910	223900	250810

3) 1st Conversion Reactor

1st Conversion Reactor is used to convert Sulphur dioxide to Sulphur trioxide having 63% conversion. Following Reaction takes place in the reactor

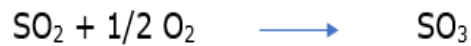

Table 3 Material Balance on 1st Conversion Reactor

1st Reactor (63%)			
Components	IN	OUT	NO_LIQ
H ₂ SO ₄	0	0	0
H ₂ O	5492.739	5492.739	0
N ₂	167616.323	167616.323	0
O ₂	23927.274	14797.79	0
SO ₂	53748.583	17205.566	0
S	0	0	0
SO ₃	0	45697.582	0
Total (lb/hr)	250810	250810	0

4) 2nd Conversion Reactor (84% Conversion)

Table 4 Material Balance on 2nd Conversion Reactor

2nd Reactor (84%)			
Components	In	Out	NO_LIQ
H ₂ SO ₄	0	0	0
H ₂ O	5492.739	5492.739	0
N ₂	167616.32	167616.323	0
O ₂	14797.79	12082	0
SO ₂	17205.566	8844.588	0
S	0	0	0
SO ₃	45697.582	56774.35	0
Total (lb/hr)	250810	250810	0

5)

6) 3rd Conversion Reactor (93% Conversion)

Table 5 Material Balance on 3rd Conversion Reactor

3rd Reactor (93%)			
Components	In	Out	NO_LIQ
H ₂ SO ₄	0	0	0
H ₂ O	5492.739	5492.739	0
N ₂	167616.323	167616.323	0
O ₂	12082	6806.259	0
SO ₂	8844.588	3702.68	0
S	0	0	0
SO ₃	56774.35	67191.999	0
Total (lb/hr)	250810	250810	0

7) 4th Conversion Reactor (99.5% Conversion)

Table 6 Material Balance on 4th Conversion Reactor

4th Reactor (99.5%)			
Components	In	Out	NO_LIQ
H ₂ SO ₄	0	0	0
H ₂ O	5492.739	5492.739	0
N ₂	167616.32	167616.3	0
O ₂	6806.259	6806.259	0
SO ₂	3702.68	3702.68	0
S	0	0	0
SO ₃	67191.999	67192	0
Total (lb/hr)	250810	250810	0

8) Primary Absorber

Sulphur trioxide is absorbed in water to form sulphuric acid with 75% conversion in Primary Absorber. Following reaction takes place in Primary absorber.



Table 7 Material Balance on Primary Absorber

Primary Absorber				
Components	SO₃ Feed	H₂SO₄ Primary Recycle	H₂SO₄ _Out	SO₃ Out
H ₂ SO ₄	0	8546.1866	12681.8578	26362.4431
H ₂ O	5492.739	110	0	0
N ₂	167616.32	0.5795	1.4849	167604.4024
O ₂	6806.259	0.0602	0.1244	10495.4024
SO ₂	3702.68	0	0	0
S	0	0	0	0
SO ₃	67191.999	57.8824	13.0607	42331.733
Total (lb/hr)	250810	8715	12700	246800

9) Secondary Absorber

The unreacted sulphur trioxide is sent to a secondary absorber where 100% conversion is achieved to produce sulphuric acid.

Table 8 Material Balance on Secondary Absorber

Secondary Absorber				
Components	SO₃ OUT From Primary	H₂SO₄ Secondary Recycle	Stack gas	Pure H₂SO₄
H ₂ SO ₄	26362.44	3414.7051	43.5691	29973.1923
H ₂ O	0	44	0	0
N ₂	167604.4	0.2317	167603.225	1.4088
O ₂	10495.4	0.0241	10495.6756	0.176
SO ₂	0	0	0	0
S	0	0	0	0
SO ₃	42331.73	23.1248	41857.7642	276.5608
Total (lb/hr)	246800	3482	220000	30250

3.3 Alternative Approach

An alternative approach has been used in our model. Through literature work, kinetics for the reaction of sulphur dioxide and oxygen has been found and employed in Aspen HYSYS.

A single plug flow reactor has been used for the oxidation of sulphur dioxide to sulphur trioxide. Using the kinetics, conversion achieved in a single plug flow reactor is same as that of four conversion reactors i.e. 99.5%.

Table 9 Plug Flow Reactor

Plug Flow Reactor			
Components	In	Out	NO_LIQ
H ₂ SO ₄	0	0	0
H ₂ O	5492.739	5492.739	0
N ₂	167616.323	167616.3	0
O ₂	23927.274	6806.259	0
SO ₂	53748.583	3702.68	0
S	0	0	0
SO ₃	0	67192	0
Total (lb/hr)	250810	250810	0

3.3 ENERGY BALANCE

Law of Conservation of Energy:

Our energy balance is based upon the law of conservation of energy which is stated by the first law of thermodynamics. It is stated as:

“Energy can neither be created nor be destroyed, but it can be converted from one form to another”

For example, internal energy stored in the molecular bonds can be converted into chemical energy, kinetic energy etc.

In most of the cases, the energy is transferred from one body to another in the form of heat. The general energy equation is as follows that we followed:

“Accumulation of Energy in System = Input of Energy in System – Output of Energy from system”

$$Q = \Delta H = m C_p \Delta T$$

<u>Units</u>		
Mass Flow	Specific Enthalpy	Heat Flow
lb/hr	Btu/lb	Btu/hr

➤ Balance on equipments

- Drying Tower
- Furnace (Conversion Reactor)
- Reactor
- Primary Absorber
- Secondary Absorber
- Heat Exchanger

3.4 Energy Balance on all the Equipments

1) Drying Tower

Moist air is being dried using sulphuric acid which is being recycled as part of the product stream. Moisture is being removed and dry air goes to the furnace to react with sulphur. Sulphuric acid attracts moisture and takes away the moisture with it.

In drying tower since, there is no accumulation of heat hence, heat input is equal to heat output. This implies that

Table 10 Energy Balance on Drying Tower

Drying Tower				
	Moist Air	H2SO4 In	Dry Air	H2SO4 Out
Mass Flow	224000	870	223900	995.1
Specific Enthalpy	137.6	3476	133.6	3961
Heat Flow	30822400	3024120	29913040	3941591
Input (Btu/hr)	3.38E07			
Output (Btu/hr)			3.38E07	

$$\Delta H = 0$$

2) Furnace

Dry air from drying tower enters the furnace and reacts with sulphur to form sulphur dioxide with 100% conversion. Following reaction takes place in the furnace.

In furnace since, there is no accumulation of heat hence, heat input is equal to heat output.

This implies that

$$\Delta H = 0$$

Table 11 Energy Balance on Furnace

Furnace (Reactor)			
	Molten S	Dry Air	SO2
Mass Flow	26910	223900	250810
Specific Enthalpy	558.8	133.6	59.32
Heat Flow	15037308	29913040	14878049.2
Input (Btu/hr)	1.48E07		
Output (Btu/hr)			1.48E07

3) Heat Exchanger:

In Heat Exchanger since, there is accumulation of heat hence, heat input is not equal to heat output. This implies that:

$$\Delta H = Q$$

Table 12 Energy Balance on Heat Exchanger

Heat Exchanger				
	SO₂ IN	BFW_IN	SO₂ OUT	Steam_Out
Mass Flow	250810	363000	250810	363000
Specific Enthalpy	534	33.85	194	262
Heat Flow	133932540	12287550	48657140	95106000
Input (Btu/hr)	1.46E08			
Output (Btu/hr)			1.46E08	

4) 1st Conversion Reactor

1st Conversion Reactor is used to convert Sulphur dioxide to Sulphur trioxide having 63% conversion. Following Reaction takes place in the reactor.

In 1st Conversion Reactor since, there is no accumulation of heat hence, heat input is equal to heat output. This implies that:

$$\Delta H = 0$$

Table 13 Energy Balance on 1st Conversion Reactor

1st Reactor (63%)		
	In	Out
Mass Flow	250810	250810
Specific Enthalpy	368.2	368.2
Heat Flow	92348242	92348242
Input (Btu/hr)	9.23E07	
Output (Btu/hr)		9.23E07

5) 2nd Conversion Reactor (84% Conversion)

Similarly, in 2nd Conversion Reactor (84% Conversion), there is no accumulation of heat hence, heat input is equal to heat output. This implies that:

$$\Delta H = 0$$

Table 14 Energy Balance on 2nd Conversion Reactor

2nd Reactor (84%)		
	In	Out
Mass Flow	250810	250810
Specific Enthalpy	422.1	422.1
Heat Flow	105866901	105866901
Input (Btu/hr)	1.05E08	
Output (Btu/hr)		1.05E08

6) **3rd Conversion Reactor (93% Conversion)**

Similarly, in 3rd Conversion Reactor (84% Conversion), there is no accumulation of heat hence, heat input is equal to heat output. This implies that:

$$\Delta H = 0$$

Table 15 Energy Balance on 3rd Conversion Reactor

3rd Reactor (93%)		
	In	Out
Mass Flow	250810	250810
Specific Enthalpy	509.2	509.2
Heat Flow	127712452	127712452
Input (Btu/hr)	1.27E08	
Output (Btu/hr)		1.27E08

7) 4th Conversion Reactor (99.5% Conversion)

Similarly, in 4th Conversion Reactor (84% Conversion), there is no accumulation of heat hence, heat input is equal to heat output. This implies that:

$$\Delta H = 0$$

Table 16 Energy Balance on 4th Conversion Reactor

4th Reactor (99%)		
	In	Out
Mass Flow	250810	250810
Specific Enthalpy	509.2	509.2
Heat Flow	127712452	127712452
Input (Btu/hr)	1.27E08	
Output (Btu/hr)		1.27E08

8) Primary Absorber

Sulphur trioxide is absorbed in water to form sulphuric acid with 75% conversion in Primary Absorber.

In primary absorber since, there is no accumulation of heat hence, heat input is equal to heat output. This implies that:

$$\Delta H = 0$$

Table 17 Energy Balance on Primary Absorber

Primary Absorber				
	SO₃ Feed	H₂SO₄ Primary Recycle	H₂SO₄ _Out	SO₃ Out
Mass Flow	250810	8715	12700	246800
Specific Enthalpy	677.1	3476	3395	636.1
Heat Flow	169823451	30293340	43116500	156989480
Input (Btu/hr)	2.00E08			
Output (Btu/hr)			2.00E08	

9) Secondary Absorber

In secondary absorber since, there is no accumulation of heat hence, heat input is equal to heat output. This implies that:

$$\Delta H = 0$$

Table 18 Energy Balance on Secondary Absorber

Secondary Absorber				
	SO₃ OUT From Primary	H₂SO₄ Secondary Recycle	Stack gas	Pure H₂SO₄
Mass Flow	246800	3482	220000	30250
Specific Enthalpy	709.3	3476	376.3	3450
Heat Flow	175055240	12103432	82786000	104362500
Input (Btu/hr)	1.87E08			
Output (Btu/hr)			1.87E08	

Chapter 4: Equipment Design

4.1 Reactor Design

In the manufacture of sulfuric acid from sulphur, the first step is the burning of sulphur in a furnace to form sulphur dioxide:



Following this step, the sulphur dioxide is converted to sulphur trioxide, using a vanadium pentoxide catalyst:

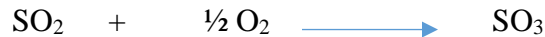

At pressures slightly higher than atmospheric, sulfur dioxide converters operate. Our designs use an absolute pressure of 2 atm. To ensure maximum conversion, the inlet temperature is regulated to the reactor. Here are two limitations. The reaction rate on the catalyst V₂O₅ is insignificant below ~700 ° F, and at no time should the reactor temperature exceed ~125 ° F. A series of temperatures should be tested, and the maximum conversion temperature above 760 ° F should be used, although the reactor temperature is above 1120 ° F.

To improve thermal efficiency by using the heat again, the cooling substance should operate at high temperatures. Dowtherm A, with a normal operating limit of about 750 ° F, seems to be the best substance, although this is occasionally used in this initial design as the coolant.

Calculations

The reactor chosen is the packed bed reactor and for instance, we have considered a single bed. Evaluating the weight of a single bed, we have divided it in four beds by dividing the weight of a single bed into four beds

Assumptions

Void Fraction	0.303
Bulk density of catalyst (kg/m³)	258
Length of tubes (m)	6
No of tubes	1100
Sphericity	0.3

1. **Design equation:** The general mole balance equations (design equation) based on the weight of catalyst is given in their differential and integral forms

$$F_{A0} \frac{dX}{dW} = -r'_A$$

2. **Kinetics**

$$K_p = \exp\left(\frac{42,311}{RT} - 11.24\right) \quad (K_p \text{ in atm}^{-1/2}, T \text{ in R})$$

$$k = \exp\left[\frac{-176,008}{T} - (110.1 \ln T) + 912.8\right]$$

3. **Rate Law**

$$-r'_{SO_2} = k \sqrt{\frac{P_{SO_2}}{P_{SO_3}}} \left[P_{O_2} - \left(\frac{P_{SO_3}}{K_p P_{SO_2}} \right)^2 \right]$$

4. **Stoichiometric relationships and expressing as a function of X**

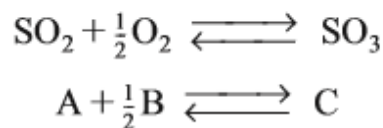

We let A represent SO_2 and v_i be the stoichiometric coefficient for species i :

$$P_i = C_i(RT) = C_{A0} \frac{(\Theta_i + v_i X)(RT)P}{(1 + \epsilon X)(T/T_0)P_0} = P_{A0} \frac{(\Theta_i + v_i X)P}{(1 + \epsilon X)P_0}$$

Substituting for partial pressures in the rate law and combining yields

$$\frac{dX}{dW} = \frac{-r'_A}{F_{A0}} = \frac{k}{F_{A0}} \sqrt{\frac{1-X}{\Theta_{SO_3} + X}} \left[\frac{P}{P_0} P_{A0} \frac{\Theta_{O_2} - \frac{1}{2}X}{1 + \epsilon X} - \left(\frac{\Theta_{SO_3} - X}{1 + X} \right)^2 \frac{1}{K_p^2} \right]$$

Weight of catalyst is deduced from above equation = **14400 kg**

Other Specifications of Reactor

1- Volume of the Catalyst

$$\text{Volume of Catalyst} = \frac{\text{Weight of Catalyst}}{\text{Bulk density}}$$

$$\text{Volume of Catalyst} = \mathbf{55.81 \text{ m}^3}$$

2- Volume of bed

$$\text{Volume of Bed} = \frac{\text{Volume of Catalyst}}{1 - \text{Void Fraction}}$$

$$\text{Volume of bed} = \mathbf{80.07 \text{ m}^3}$$

3- Diameter of bed

$$\text{Diameter of Bed (D}^3) = \frac{4V_{\text{bed}}}{3\pi}$$

$$\text{Diameter of bed} = \mathbf{3.23 \text{ m}}$$

4- Height of bed

$$\text{Height of Bed} = \frac{V}{\pi D^2 / 4}$$

Height of bed= **9.71 m**

5- Height of Reactor

$$\text{Height of Reactor } (H_R) = \text{Height of Bed} + 0.15(\text{Height of Bed})$$

Height of Reactor = **11.17m**

6- Volume of Reactor

$$\text{Volume of Reactor} = H_R \left(\frac{\pi D^2}{4} \right)$$

Volume of Reactor = 95 m³

Results

Weight of catalyst (kg)	14400
Volume of catalyst (m³)	55.81
Volume of bed (m³)	80.07
Height of bed (m)	9.71
Diameter of bed (m)	3.23
Height of reactor (m)	11.17
Volume of reactor (m³)	95

4.2 Absorber Design

Absorber is an important equipment used in the contact process to produce sulphuric acid. A chemical reaction is taking place inside the absorber; thus, the absorption process is chemisorption. Sulphuric trioxide reacts with water to form an intermediate compound, Oleum which further reacts with water to form sulphuric acid. But in our simulation model, we have not introduced the intermediate compound, instead we have employed the overall reaction in the absorber to produce sulphuric acid



Absorber is a vertical and cylindrical vessel which uses packings to increase the contact area and time of absorbents. The packings which we are using in our process are Ceramic Intalox Saddles.

Design Specifications

- Packed bed vessel or Tower
- Material of packing: Intalox saddles
- Material of construction: Ceramics

Given

Sulphuric acid flow rate (outlet) $m_L =$	9610.78 kg/hr
Density of Sulphuric acid (ρ_L) =	1734 kg/m ³
Density of water ($\rho_L, \text{H}_2\text{O}$) =	999.5 kg/m ³
Feed gas flow rate (m_G) =	1.138e5 kg/hr
Density of feed gas (ρ_G) =	1.176 kg/m ³
Dynamic viscosity of Sulphuric acid = $\eta =$	0.00076 Pa.s
Flooding factor = $f =$	0.7
Packing Factor = $F_p =$	40

1. **F_{LG}**

$$F_{LG} = \frac{m_L (\rho_G)^{0.5}}{m_G (\rho_L)^{0.5}}$$

$$F_{LG} = \mathbf{0.0022}$$

2. **F_p**

$$F_p = 0.8787 + 2.6776 \left(\frac{\rho_{L,H2O}}{\rho_L} \right) - 0.6313 \left(\frac{\rho_{L,H2O}}{\rho_L} \right)^2$$

$$F_p = \mathbf{0.454}$$

3. **F_η**

$$F_{\eta} = 0.96 \eta_L^{0.19}$$

$$F_{\eta} = \mathbf{0.244}$$

4. **Y**

$$Y = \exp(-3.7121 - 1.0371 \ln F_{LG} - 0.1501 \ln(F_{LG})^2 - 0.007544 \ln(F_{LG})^3)$$

$$Y = \mathbf{0.284}$$

5. **Flooding Velocity (W_{G,max})**

$$Y = \frac{W_{G,max}^2 F_p F_{\rho} F_{\eta} \rho_G}{\rho_{L,H2O}}$$

$$W_{G,max} = \mathbf{7.4 \text{ m/s}}$$

6. Diameter of Absorber

$$D = \frac{2}{(\pi)^{0.5}} \left(\frac{m_G}{\rho_G f W_{G,max}} \right)^{0.5}$$

D= **2.6 m**

7. NTU

m=0

x_{in}=0

Y_{in} = 1.23x10⁻³

Y_{out} = 1.23x10⁻⁵

$$NTU = 1(1 - mV/L) * \ln \left(1 - \frac{mV}{L} \right) * \left(\frac{Y_{IN} - mx_{out}}{Y_{OUT} - mx_{in}} \right) + mV/L$$

$$NTU = \ln \frac{Y_{IN}}{Y_{OUT}}$$

NTU = **approximately 5**

8. Height Calculation

From the following table

HTU for 50mm packing size = 1

Thus Height(Z)

Packing size (mm)	HTU(m)
25	0.3-0.6
38	0.5-0.75
50	0.6-1

$$Z = HTU * NTU$$

Z= 1 * 5 = **5m**

9. **Total Height** = $Z + 2.5 = 7.5 \text{ m}$

10. **Number of Packings**

$D = 2.6 \text{ m}$

$h = 5 \text{ m}$

$$Volume = \frac{\pi D^2 h}{4}$$

Volume = **26.5 m³**

From the following table

Table 19 Parameters of saddles

Technical Parameter:

Name	Normal mm	Diameter*Height* Thickness mm	Surface area m ² /m ³	Void space %	Bulk density kg/m ³	No.elements per/m ³	Packing factor m ⁻¹
Intalox saddles	ø16	16*12*2	450	70	710	382000	1311
	ø25	25*19*3	250	74	610	84000	617
	ø38	38*30*4	164	75	590	25000	389
	ø50	50*40*5	142	76	560	9300	323
	ø76	76*57*9	92	78	520	1800	194

No. of Packings/ m³ = **9300**

Total No. of Packings = 9300 * 26.5 = **246,450**

4.3 Heat Exchanger Design

Given:

Working for a 21 ¼ in ID exchanger having 200 tubes with 1 in dia, 13 BWG, 16' 0" long and pitch 1 ¼ in. Two tube passes, baffle spacing 5 in.

Tube side inlet $T = t_{in} = 1092.222^{\circ} \text{C} = 1998^{\circ} \text{F}$

Tube side outlet $T = t_{out} = 450^{\circ} \text{C} = 842^{\circ} \text{F}$

Shell side inlet $T = t_{in} = 65^{\circ} \text{C} = 149^{\circ} \text{F}$

Shell side outlet $T = t_{out} = 170^{\circ} \text{C} = 338^{\circ} \text{F}$

Solution:

Tube side $c_p(\text{SO}_2) = 0.59445 \text{ Btu/lb } ^{\circ}\text{F}$

Shell side $c_p(\text{H}_2\text{O}) = 0.49815$

$\text{Btu/lb } ^{\circ}\text{F}$

$M_{\text{SO}_2} = 7875 \text{ lbmol/hr}$

$Q_{\text{hot}} = (7875)(0.59445)(1998-842) = \text{lb/hr} \times \text{Btu/lb.}^{\circ}\text{F} \times$

$^{\circ}\text{F} = 8.0731 \times 10^7 \text{ Btu/hr}$

$M_{\text{H}_2\text{O}} = 23600 \text{ lbmol/hr}$

	HOT FLUID		COLD FLUID	
	T1=1998	high T	t2=338	$\Delta t_2 = 1660$
	T2=842	low T	t1=149	$\Delta t_1 = 693$
Diff	T1-T2=1156		t2-t1=189	

$\text{LMTD} = (1660-693)/\ln(1660/693) = 110.6^{\circ}\text{F}$

$$R = 1156/189 = 6.11 \quad S = 189/1849 = 0.1022$$

$$F_T = 0.968$$

$$\Delta t = 0.968 \times 110.6 = 107.1^\circ\text{F}$$

$$A_s \Delta t_c / t_h = 0.417$$

For 42 API crude, $k_c = 0.21$ and $F_c = 0.51$

$$T_c = T_2 + F_c (T_1 - T_2) = 842 + (0.51)(1156) = 1431^\circ\text{F}$$

$$t_c = t_1 + F_c (t_2 - t_1) = 149 + (0.51)(189) = 245^\circ\text{F}$$

Hot fluid, tube side

$$\text{Flow area} = a_t' = 0.515 \text{ in}^2$$

$$a_t = N a_t' / 144n$$

$$= (169)(0.515) / 144 \times 2$$

$$= 0.3022 \text{ ft}^2$$

$$G_a = w / a_t = 7875 / 0.3022$$

$$G_a = 26058 \text{ lb/hr.ft}^2$$

Assuming viscosity at t_c , 8.7 lb/ft.hr lb/ft.hr

$$Re = D e G_a / \mu$$

$$D = 0.631 / 12 = 0.0525 \text{ ft}$$

$$Re = (0.0525)(26058) / 8.7$$

$$= 51410$$

$$L/D = 16 / 0.0675 = 237$$

Cold fluid, shell side

$$a_s = 1 D X C' B / 144 Pt$$

$$= 29.25 \times 0.25 \times 5 / 144$$

$$\times 1.9 = 0.261 \text{ ft}^2$$

$$G_a = w / a_s = 23600 / 0.261$$

$$= 90421 \text{ lb/hr.ft}^2$$

Assuming viscosity at t_c , 0.978

$$Re = D e G_a / \mu$$

$$D = 0.787 / 12 = 0.0655 \text{ ft}$$

$$Re = (0.0655)(90421) / 0.97$$

$$= 73821$$

$$jH = 200$$

$$jH = 110$$

$$At T_c = 1431^\circ F$$

$$At t_c = 245^\circ F$$

$$C = 0.52 \text{ Btu/lb.}^\circ F$$

$$C = 0.58 \text{ Btu/lb.}^\circ F$$

$$k = 26 \text{ Btu/ft.hr.}^\circ F$$

$$k = 29 \text{ Btu/ft.hr.}^\circ F$$

$$hi/Q_t = jH \times k/D \times (c\mu/k)^{1/3}$$

$$hi/Q_s = jH \times k/D \times (c\mu/k)^{1/3}$$

$$= 110 \times 26/0.0525 \times (0.52 \times 8.7/26)^{1/3}$$

$$= 110 \times 26/0.0655 \times (0.58 \times 0.97/0.26)^{1/3}$$

$$hs/at = 4492$$

$$hi/Q_s = 9917$$

$$hi/at \times 1D / OD = 40.257 \times 0.87/1$$

$$hi/Q_t = 7950$$

$$As t_w = t_c + (ho/Q_s)/(hi/Q_t + ho/Q_s) \times (T_c - t_c)$$

$$= 245 + (4492/7950 + 4492) \times 825$$

$$T_w = 542.8^\circ F$$

$$At 548^\circ F, \mu_{ws} = 2468 \text{ and } \mu_{wt} = 3.12$$

$$Q_s = (\mu/\mu_w)^{0.14}$$

$$= (0.97/0.2468)^{0.14}$$

$$= 1.16$$

$$Q_t = (\mu/\mu_w)^{0.14}$$

$$= (8.7/3.12)^{0.14}$$

$$= 1.54$$

$$ho/Q_t \times Q_t = 4492 \times 1.54 = 6918$$

$$ho/Q_s \times Q_s = 7950 \times 1.16 = 5210$$

$$As U_c = h_{io} h_o / (h_{io} + h_o) = (9022 \times 3416) / (9022 + 3416) = 251.9 \text{ lb/hr.ft}$$

$$As a_t'' = 0.2618 \text{ ft}^2/\text{lb.ft}$$

$$\text{Total surface area} = 169 \times 19' 685'' \times 0.42618 = 701 \text{ ft}^2 \text{ And as}$$

$$UD = Q / A \Delta t \text{ Assuming equimolar heat transfer from tube hot fluid to shell fluid } UD = 5624262 / (837.76 \times 86.47)$$

$$UD = 53.7 \text{ Btu/hr.ft}^2 \text{ } ^\circ\text{F}$$

Now for R_d ,

$$As R_d = U_c - UD / U_c UD = (251.9 - 53.7) / (251.9 \times 53.7)$$

$$R_d = 0.0146$$

Pressure Drop

Tube side(hot fluid)

For Re = 51410

$$f = 0.0016 \text{ ft}^2$$

$$s = 1$$

$$\Delta P_t = \frac{(f \cdot G_t^2 \cdot L \cdot n) / (5.22 \times 10^{10} \cdot D_s \cdot Q_t)}{2(16)(2)}$$
$$\frac{(0.0034)(441834.45)}{(5.22 \times 10^{10} \cdot 0.0675 \times 0.078 \times 1.154)} = 1.37 \text{ psi}$$

$$\Delta P_r = 4n/s \cdot v^2/2g$$

$$= 4(8)/0.078 \times 0.022$$

$$= 1.56 \text{ psi}$$

$$\Delta P_T = \Delta P_t + \Delta P_r$$

$$1.37 + 1.6 \text{ psi}$$

$$= 3.5 \text{ psi} < 10 \text{ psi}$$

Shell side(cold

For Re = 73820

$$f = 0.00014$$

$$s = 1$$

$$D_s = 29.25/12 = 2.43 \text{ ft}$$

$$\Delta P_s = 5.39 \text{ psi} < 10 \text{ psi}$$

Chapter 5: ECONOMIC ANALYSIS

5.1 Equipment Cost

Storage Tank-01

Capacity = 500 metric tons

Design Pressure = 15 psig

Material of construction = Stainless

Steel

Cost = 110,000\$ -----

-

EQ(1)

Reactor (PFR)

Height = 6 m

Operating Pressure = 15bar

Column Diameter= 5 m

Construction Material = Stainless Steel

Cost of Vessel = 44600\$ ----- (i)

Supporting media = Grating Mesh

Material of mesh = Cast Iron

Diameter of Trays= Diameter of Column = 5 m

Number of Support media = 4

Catalyst cost = 27 \$/ Kg

Total catalyst weight = 14400 Kg

Total catalyst cost = 388800 \$ (ii)

Total Tray Cost = 4*10000\$ = 40,000\$----- (iii)

Total Cost= Adding Eq(i),(ii) and

Eq(iii)

Total Cost = 473,400 \$ ----- EQ(2)

Heat Exchanger

Heat Transfer Area = 700 ft² == 53 m²

Type of Heat Exchanger = U-Tube

Operating Pressure = 14.7 psig

Pressure factor = 1

U-Tube factor = 0.85

Material of Shell = Carbon Steel

Material of Tubes = Stainless Steel

Cost Of Heat Exchanger = 800000 * 0.85 * 1 = 126480\$-----EQ(3)

Cooler

Type of Cooler = U-Tube

Area = 10.1m²

Material of Shell = Carbon Steel

Number of Tubes = 8

Operating Pressure = 5 bar

Number of Coolers = 02

Total Cost = 2* 6,300 * 1.0 * 0.85 = 10,710\$

Total Cost == 11,000\$ ----- EQ(4)

Absorber (I)

Vessel cost = 12500 \$

Pressure flow = 1

Material factor = 2

Total Vessel Cost = 25000 \$

Material Cost = \$ 960/ m³

Volume of packing = 26.5 m³

Total Packing Cost = 25440 \$

Total Absorber Cost = 50440 \$

Total Absorber Cost in 2019 = 93800 \$ EQ (5)

Absorber (II)

Vessel cost = 10500 \$

Pressure flow = 1

Material factor = 2

Total Vessel Cost = 21000 \$

Material Cost = \$ 960/ m³

Volume of packing = 25 m³

Total Packing Cost = 24000 \$

Total Absorber Cost = 45000 \$

Total Absorber Cost in 2019 = 83,700 \$ EQ (6)

Furnace

Height of furnace = 8 m

Heat Duty = 15033912.786 Btu/hr

Cost of furnace = 212,784 \$ EQ (7)

Drying Tower

Diameter of the Vessel = 4.3 m

Height of Vessel = 9.8 m

Packing Height = 4.12 m

Cost of drying tower = 223,365 \$ EQ (8)

Cooler

Type of Cooler = U-Tube

Area = 10.1m²

Material of Shell = Carbon Steel

Demanded speed [rpm]= 60

Operating Pressure = 5 bar

Number of Coolers = 02

Total Cost = 2* 6,300 * 1.0 * 0.85 = 10,710\$

Total Cost == 14,560\$ -----

-- EQ(9)

Adding Eq (1) To Eq (9) will give us total Equipment cost

Purchase Cost Equipment (PCE) = 1.283M \$

5.2 Physical Plant Cost

Table 20 Physical Plant Cost

Symbol	Correction Factor	Value
F1	Equipment Erection	0.40
F2	Piping	0.70
F3	Instrumentation	0.20
F4	Electrical	0.10

Physical Plant Cost (PPC) = PCE (1+0.40+0.70+0.20+0.10)\$

PPC= 3.1M \$

5.3 Fixed & Working Capital

Table 21 Fixed & Working Capital

Factor Symbol	Correction Factor	Value
F10	Design & Engineering	0.30
F11	Contractor Fee	None
F12	Contingencies	0.10

Fixed Capital = $PPC \cdot (1 + 0.30 + 0.10) = 2,165,080\$$

Fixed Capital = 4.3M \$

Now, **Working Capital** = Fixed Capital * 0.05 = 0.22M

\$ Working Capital = 0.22M \$

Total Investment

Total Investment = Working Capital + Fixed

Capital **Total Investment** = 4.56 Million

5.4 Variable cost

Attainment = 95%

Operating Time = $365 * 0.95 = 347 \text{ days/y} = 347 \text{ days/y} * 24 = 8,328 \text{ hours/year}$

Table 22 Variable cost

Parameter	Variable Value	Cost (\$)
Raw Material	None	0
Miscellaneous Material	10% of Maintenance Cost	10,825.43
Utilities(Steam)	12\$/ton	11,659
Utilities(Cooling Water)	0.01\$ /Ton or 1Cent/Ton	416.4
Power	1.5Cent/MJ	1,873.8
Total Cost = 24,774.63\$		

5.5 Fixed Cost

Table 23 Fixed Cost

Variable	Cost(\$)
Maintenance	108,254.3
Operating labour	30,000
Plant Overhead	15,000
Laboratory	9,000
Capital Charges	129,905
Insurance	21,650

TOTAL = 313,809\$

Direct Production Cost

Direct Production Cost = Fixed Cost + Variable Cost = 338,583 \$

5.6 Payback Period

Annual Operating Cost = 840,000 \$

Assume Annual Cash Flow = 1.8M \$

Payback Period = Investment / Annual Cash Flow

Payback Period = 4.56/1.8 = 2.5 years

Payback Period = **2.5 years**

Chapter 6: Simulation

6.1 Simulation of Aspen HYSYS Model

General Process Description

Sulfur is introduced with the dry air into the furnace after the expulsion of water from the feed air in the drying section. An oxidation reaction happens in the sulfur burner. At that point the sulfur dioxide gas and the un-responded air are cooled from 1998°F to 842°F before entering the where Sulphur dioxide reacts with the oxygen to give Sulphur trioxide. Sulfur dioxide and air undergo the catalytic oxidation reaction in the PFR. Since the reaction is highly exothermic in nature, the temperature of the system increases at a considerable rate and thus increases the reaction kinetics. However, this elevated temperature could damage the catalyst and thus, requires cooling. For this purpose, the reactor is partitioned into 4 stages and each stage is provided with a cooling system so that before each entering into each stage, the Sulphur trioxide stream is cooled down. This results in higher conversion and reaction rate. Because of the limitation of Aspen HYSYS software

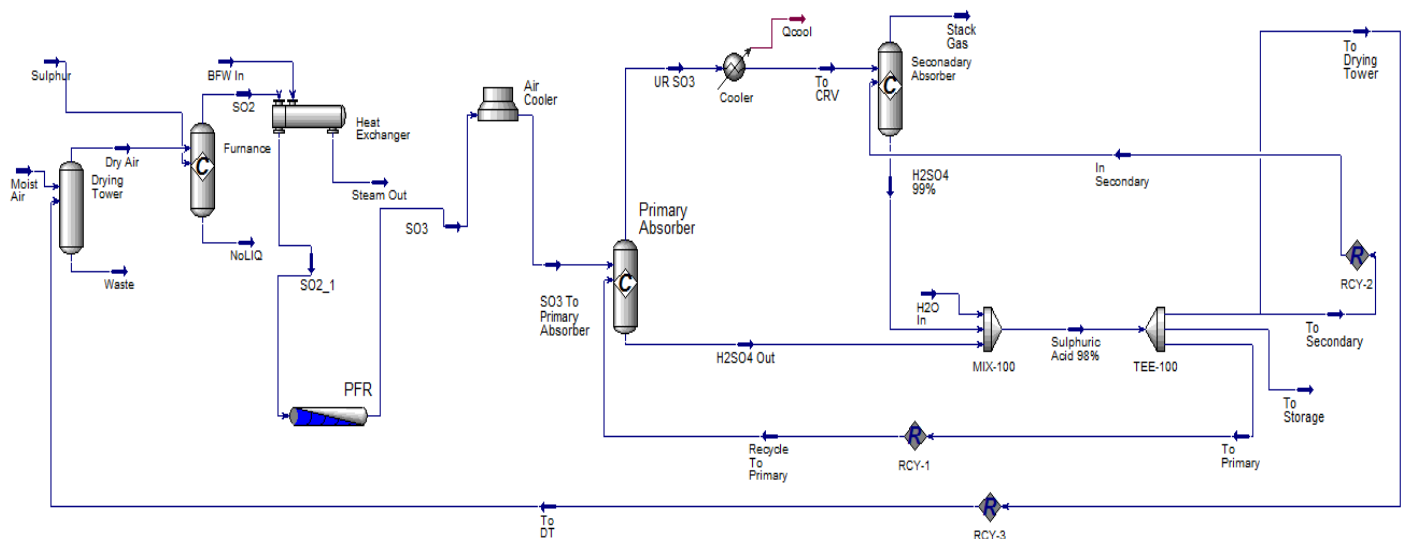

Figure 6 Simulation

we could not represent the four stages using a PFR. We could use 4 conversion reactors instead but that would result in additional costs and further calculations. Another way could be by using reaction kinetics of PFR we calculate the conversion of each conversion reactor and then install a cooler after each conversion reactor to cool down the system. Following is the overall simulation of the process:

The Air Cooler's cooled outlet, which contains sulfur trioxide, is transferred to the main absorption tower, where 98% H₂SO₄ is reacted to form 98,5% H₂SO₄. The stack gas is released from the nitrogen absorption tower. The concentration of stack SO₂ is less than 500ppm, so that the exhaust gas is released into the atmosphere. Since absorbent acid is continually concentrated, some means are needed to dilute the acid part that is released from the absorbers and is recirculated. Therefore, 98.0% H₂SO₄ and de-mineralized water and 98.5% H₂SO₄ from the drying tower are feed into the circulation tank. The resulting H₂SO₄ concentration from the circulation tank is 98.1 percent, divided into two parts. The absorption tower is refreshed and recycled in a single part. The rest is also refrigerated and divided into two more parts. The final product contains 98% H₂SO₄ is one of these sections. The second part of the drying tower is recycled.

Component List:

Following is the list of components that were selected in the Aspen HYSYS:

Table 24 Components in Aspen HYSYS

Components	Component name	Formula
H ₂ O	Water	H ₂ O
H ₂ SO ₄	Sulfuric Acid	H ₂ SO ₄
SO ₂	Sulfur di-oxide	SO ₂
SO ₃	Sulfur tri-oxide	SO ₃
S	Sulfur	S
N ₂	Nitrogen	N ₂
O ₂	Oxygen	O ₂
H ₃ O ⁺	Hydronium Ion	H ₃ O ⁺
-	Bi- Sulfate ion	-
HSO ₄		HSO ₄
--	Sulfate ion	2-
SO ₄		SO ₄

Fluid Package:

The fluid package we used in the simulation model is the “Extended NRTL”. The fluid package used in this simulation was the General NRTL property package employing the Virial vapor phase model as referred in the literature on model selection for the vapor phase. Kinetic reactions were configured for acetic acid from methanol and carbon monoxide.

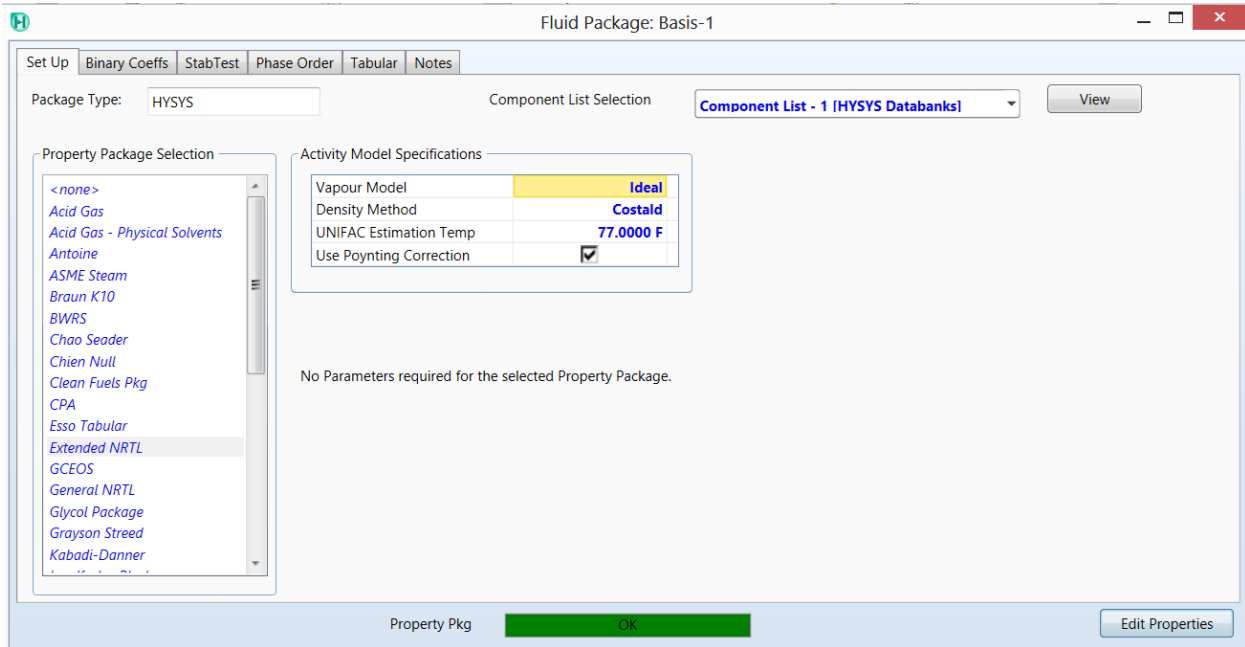

Figure 7 Fluid Package Aspen HYSYS

6.2 Reactions

i. Furnace

Specification Type	Stoichiometry
Conversion	$S + O_2 \rightarrow SO_2$

ii. PFR

Specification Type	Stoichiometry
Kinetic	$SO_2 + 0.5O_2 \rightarrow SO_3$

iii. Absorption Reaction

Specification Type	Stoichiometry
Conversion	$H_2O + SO_3 \rightarrow H_2SO_4$

These are the basic reactions that occur in the process. However, there are some other reactions that take place for example, the formation of oleum. Initially, oleum is produced in the absorption towers and then this oleum is mixed with water that forms the sulfuric acid. Following are the reaction sets that are implied in the model:

Conversion Reaction: Rxn-14

Component	Mole Weight	Stoich Coeff
SO2	64.063	-1.000
SO3	80.058	1.000
Oxygen	32.000	-0.500
Add Comp		

Balance Error: 0.00000
Reaction Heat (25 C): -4.3e+04 Btu/lbmole

Stoichiometry Info

Basis

Base Component	SO2
Rxn Phase	VapourPhase
Co	63.00
C1	<empty>
C2	<empty>

Conversion (%) = Co + C1*T + C2*T^2
(T in Kelvin)

Ready

Conversion Reaction: Rxn-15

Component	Mole Weight	Stoich Coeff
SO2	64.063	1.000
S_Liq_150	32.066	-1.000
Oxygen	32.000	-1.000
Add Comp		

Balance Error: 0.00000
Reaction Heat (25 C): -1.3e+05 Btu/lbmole

Stoichiometry Info

Basis

Base Component	S_Liq_150
Rxn Phase	Overall
Co	100.0
C1	<empty>
C2	<empty>

Conversion (%) = Co + C1*T + C2*T^2
(T in Kelvin)

Ready

Conversion Reaction: Rxn-20

Component	Mole Weight	Stoich Coeff
SO2	64.063	-1.000
SO3	80.058	1.000
Oxygen	32.000	-0.500
Add Comp		

Balance Error: 0.00000
Reaction Heat (25 C): -4.3e+04 Btu/lbmole

Stoichiometry Info

Basis

Base Component	SO2
Rxn Phase	VapourPhase
Co	84.00
C1	<empty>
C2	<empty>

Conversion (%) = Co + C1*T + C2*T^2
(T in Kelvin)

Ready

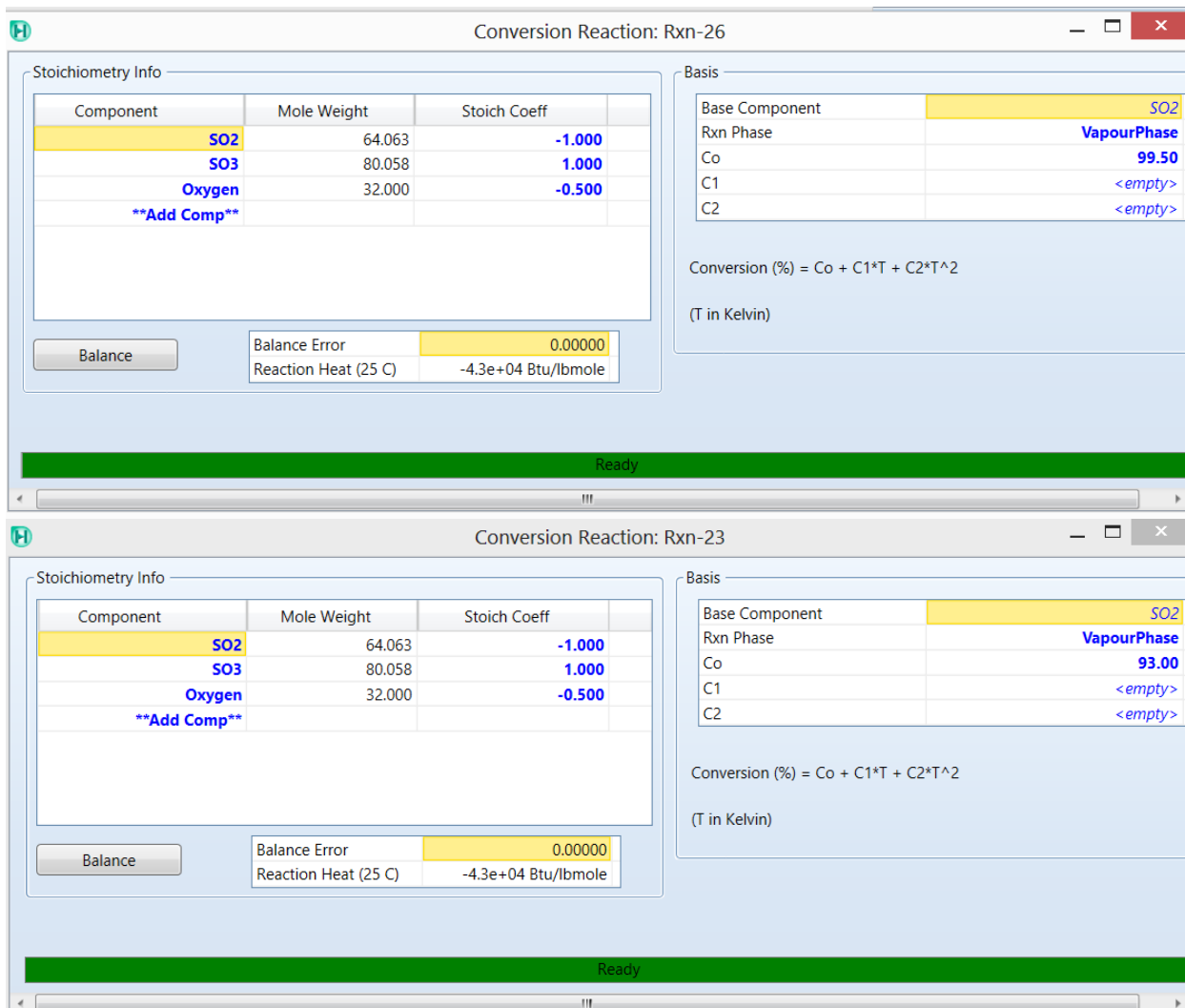

Figure 8 Reactions Aspen HYSYS

Kinetic Reaction: Rxn-32

Stoichiometry and Rate Info

Component	Mole Wt.	Stoich Coeff	Fwd Order	Rev Order
SO2	64.063	-1.000	1.00	0.00
Oxygen	32.000	-0.500	0.50	0.00
SO3	80.058	1.000	0.00	1.00
Add Comp				

Balance

Balance Error	0.00000
Reaction Heat (25 C)	-4.3e+04 Btu/lbmole

Basis

Basis	Molar Conc'n
Base Component	SO2
Rxn Phase	VapourPhase
Min. Temperature	-459.7 F
Max Temperature	5432 F

Basis Units: lbmole/ft3
Rate Units: lbmole/ft3-hr

Forward Reaction

A	5.0000e+010
E	0.00000
b	0.00000

Reverse Reaction

A'	1.5000e+006
E'	0.00000
b'	0.00000

Equation Help

$r = k*f(\text{Basis}) - k'*f'(\text{Basis})$

$k = A * \exp \{ -E / RT \} * T ^b$

$k' = A' * \exp \{ -E' / RT \} * T ^b'$

T in Kelvin

Ready

Conversion Reaction: Rxn-29

Stoichiometry Info

Component	Mole Weight	Stoich Coeff
SO3	80.058	-1.000
H2O	18.015	-1.000
H2SO4	98.080	1.000
Add Comp		

Balance

Balance Error	0.00000
Reaction Heat (25 C)	-4.2e+04 Btu/lbmole

Basis

Base Component	SO3
Rxn Phase	Overall
Co	75.00
C1	<empty>
C2	<empty>

Conversion (%) = $Co + C1*T + C2*T^2$

(T in Kelvin)

Ready

6.3 Unit Operation Models

Below detailed are the unit task models connected in the simulated model with their working conditions.

1) Drying Tower:

The basic function of the drying tower is to remove any moisture content present in the feed air that is to be supplied to the furnace.

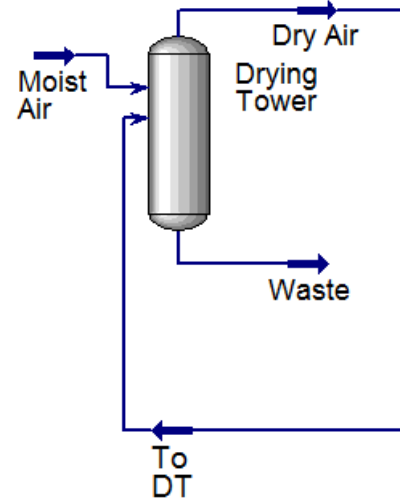

Separator: Drying Tower

Design Reactions Rating Worksheet Dynamics

Worksheet

Name	Moist Air	To DT	Waste	Dry Air
Vapour	1.0000	0.0001	0.0000	1.0000
Temperature [F]	104.0	252.2	107.2	107.2
Pressure [psia]	20.31	14.47	14.47	14.47
Molar Flow [lbmole/hr]	7882	9.377	16.58	7875
Mass Flow [lb/hr]	2.240e+005	869.4	994.4	2.239e+005
Std Ideal Liq Vol Flow [barrel/day]	1.767e+004	32.51	41.28	1.766e+004
Molar Enthalpy [Btu/lbmole]	-3911	-3.223e+005	-2.376e+005	-3798
Molar Entropy [Btu/lbmole-F]	45.08	23.83	6.468	45.80
Heat Flow [Btu/hr]	-3.083e+007	-3.022e+006	-3.938e+006	-2.991e+007

Delete OK Ignored

Figure 9 Drying Tower Aspen HYSYS

2) Furnace:

The main reaction occurring inside the furnace is the conversion of the molten Sulphur into Sulphur dioxide in the presence of dry air. Following are its specifications and the worksheet:

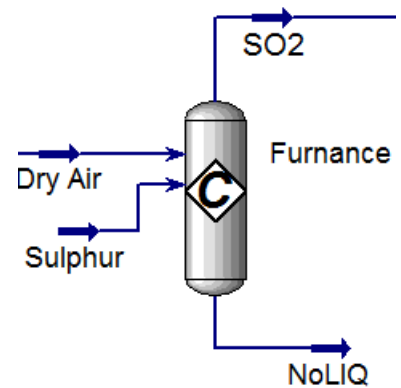

Conversion Reactor: Furnance - Set-2

Design Reactions Rating Worksheet Dynamics

Worksheet

Name	Sulphur	Dry Air	NoLIQ	SO2
Vapour	0.0000	1.0000	0.0000	1.0000
Temperature [F]	278.4	107.2	1998	1998
Pressure [psia]	20.31	14.47	14.47	14.47
Molar Flow [lbmole/hr]	839.1	7875	0.0000	7875
Mass Flow [lb/hr]	2.691e+004	2.239e+005	0.0000	2.508e+005
Std Ideal Liq Vol Flow [barrel/day]	1018	1.766e+004	0.0000	1.869e+004
Molar Enthalpy [Btu/lbmole]	1.792e+004	-3798	1.456e+004	-1889
Molar Entropy [Btu/lbmole-F]	66.44	45.80	56.09	58.73
Heat Flow [Btu/hr]	1.503e+007	-2.991e+007	0.0000	-1.488e+007

Delete OK Ignored

Figure 10 Furnace Aspen HYSYS

1) Heat Exchanger:

U-tube heat exchanger was used in the simulated model. Cooling water was used as the cooling media to lower the temperature of the Sulphur dioxide before sending it to the PFR:

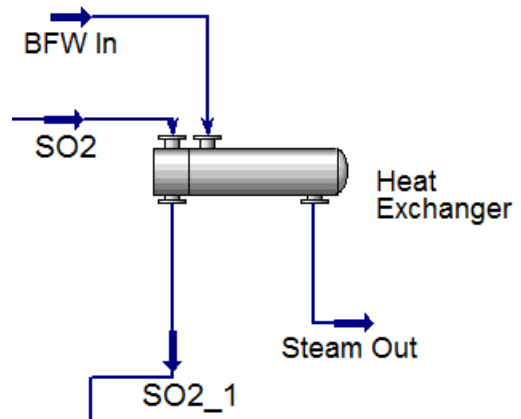

Heat Exchanger: Heat Exchanger

Design Rating Worksheet Performance Dynamics Rigorous Shell&Tube

Worksheet	Name	SO2	SO2_1	BFW In	Steam Out
Conditions	Vapour	1.0000	1.0000	0.0000	1.0000
Properties	Temperature [F]	1998	842.0	149.0	338.0
Composition	Pressure [psia]	14.47	17.40	14.70	87.02
PF Specs	Molar Flow [lbmole/hr]	7875	7875	3983	3983
	Mass Flow [lb/hr]	2.508e+005	2.508e+005	7.175e+004	7.175e+004
	Std Ideal Liq Vol Flow [barrel/day]	1.869e+004	1.869e+004	4923	4923
	Molar Enthalpy [Btu/lbmole]	-1889	-1.173e+004	-1.212e+005	-1.017e+005
	Molar Entropy [Btu/lbmole-F]	58.73	52.98	3.852	29.33
	Heat Flow [Btu/hr]	-1.488e+007	-9.234e+007	-4.826e+008	-4.052e+008

Delete OK Update Ignored

Figure 11 Heat Exchanger Aspen HYSYS

1) Plug Flow Reactor:

PFR is the major equipment in the model where the main reaction is taking place. The conversion of the Sulphur dioxide into Sulphur trioxide in the presence of vanadium pentoxide acting as a catalyst. The reaction kinetics are as follows:

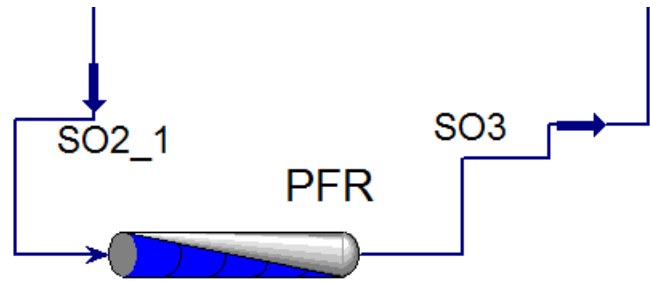

Plug Flow Reactor: PFR - Set-9

Design Reactions Rating Worksheet Performance Dynamics

Worksheet

	SO2_1	SO3
Name	SO2_1	SO3
Vapour	1.0000	1.0000
Temperature [F]	842.0	1370
Pressure [psia]	17.40	17.40
Molar Flow [lbmole/hr]	7875	7457
Mass Flow [lb/hr]	2.508e+005	2.508e+005
Std Ideal Liq Vol Flow [barrel/day]	1.869e+004	1.769e+004
Molar Enthalpy [Btu/lbmole]	-1.173e+004	-1.238e+004
Molar Entropy [Btu/lbmole-F]	52.98	56.15
Heat Flow [Btu/hr]	-9.234e+007	-9.234e+007

Delete OK Ignored

Figure 12 Plug Flow Reactor Aspen HYSYS

3) Primary Absorber:

In primary absorber, the Sulphur trioxide is being converted to the sulfuric acid (oleum) in the presence of the water.

Sulfuric acid produced is sent to the storage tank where it is mixed with water to dilute it to required concentration.

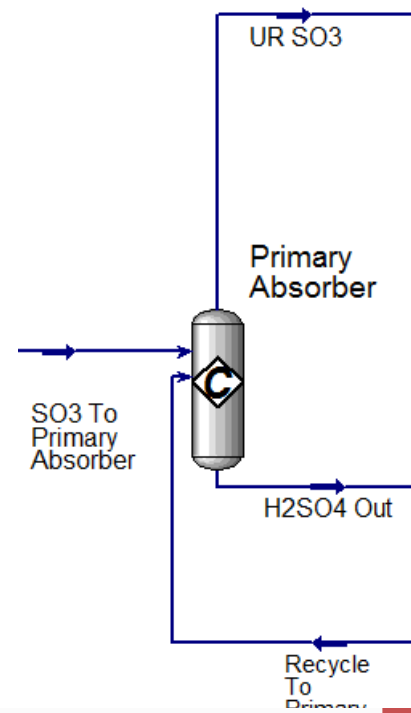

Conversion Reactor: Primary Absorber - Set-6

Worksheet	Name	SO3 To Primary A	Recycle To Primar	H2SO4 Out	UR SO3
Conditions	Vapour	1.0000	0.0001	0.0000	1.0000
Properties	Temperature [F]	158.0	252.3	387.5	387.5
Composition	Pressure [psia]	14.47	14.47	14.47	14.47
PF Specs	Molar Flow [lbmole/hr]	7457	93.81	129.3	7111
	Mass Flow [lb/hr]	2.508e+005	8697	1.267e+004	2.468e+005
	Std Ideal Liq Vol Flow [barrel/day]	1.769e+004	325.2	468.9	1.739e+004
	Molar Enthalpy [Btu/lbmole]	-2.275e+004	-3.223e+005	-3.328e+005	-2.206e+004
	Molar Entropy [Btu/lbmole-F]	47.37	23.83	35.96	50.28
	Heat Flow [Btu/hr]	-1.696e+008	-3.024e+007	-4.302e+007	-1.569e+008

Buttons: Delete, OK, Ignored

Figure 13 Primary Absorber Aspen HYSYS

1) Secondary Absorber:

The function of secondary absorber is same as that of primary absorber. The Sulphur trioxide is being converted to the sulfuric acid (oleum) in the presence of the water. Sulfuric acid produced is sent to the storage tank where it is mixed with water to dilute it to required concentration.

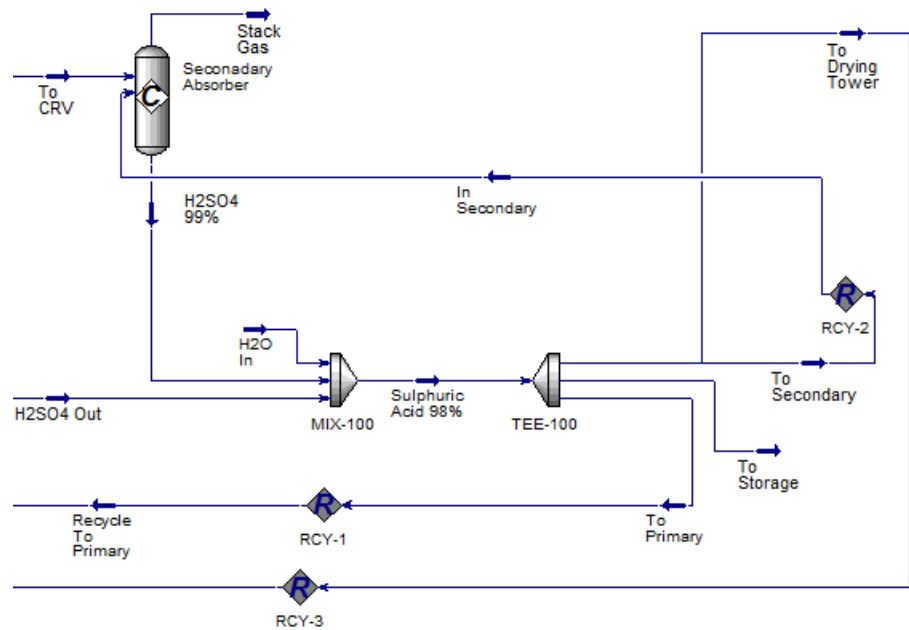

Mixer: MIX-100

Worksheet					
	Name	H2SO4 99%	H2SO4 Out	H2O In	Sulphuric Acid 98%
Conditions	Vapour	0.0000	0.0000	0.0000	0.0001
Properties	Temperature [F]	203.0	387.5	77.00	252.2
Composition	Pressure [psia]	14.47	14.47	14.70	14.47
PF Specs	Molar Flow [lbmole/hr]	309.1	129.3	30.53	468.9
	Mass Flow [lb/hr]	3.025e+004	1.267e+004	550.0	4.348e+004
	Std Ideal Liq Vol Flow [barrel/day]	1119	468.9	37.74	1626

Tee: TEE-100

Design	
Splits	
	Flow Ratios
To Primary	0.2000
To Secondary	8.000e-002
To Drying Tower	2.000e-002
To Storage	0.7000

Maximum flow spec

 Maximum flow on

Stream	
Molar Flow [lbmole/hr]	<empty>
Mass Flow [lb/hr]	<empty>

Overflow stream	
Molar Flow [lbmole/hr]	<empty>
Mass Flow [lb/hr]	<empty>

Figure 14 Secondary Absorber Aspen HYSYS

Chapter 7: Sensitivity Analysis



7.1 Introduction

- Analyzing the process variables effect on the production of sulphuric acid.
- Sensitivity Analysis has been accomplished using MATLAB code to extract data from an excel sheet and apply it in Aspen HYSYS.
- Initially, Aspen HYSYS Model is connected to an excel sheet where various process variables and output variables are set.
- Cases are set for each relation i.e. 20 cases have been selected to study the sensitiveness of output variable with respect to process variables.
- A MATLAB Code has been generated to assign values for each process variable in Excel Sheet.
- 5-10 % Variation has been set for each process variable.

7.2 MATLAB Code

```
clc
clear
filename = 'ahmad2.xlsx'; %File name
sheet = 'Sheet11';%sheet name
xlRange = 'D3'%specify the column whose values will be updated/changed
subsetA = xlsread (filename, sheet,xlRange)%within the sheet extract values of column D

subsetAn= [];
InputValues= [];

randomValue = 0.95 + (1.05- 0.95).*rand(length(subsetA),20);
for j=1:20
for i=1:length(subsetA)
subsetAn(i,j)=subsetA(i)*randomValue(i,j);%5 percent increase in original values of column D
end
end
filename = 'ahmad2.xlsx';
xlswrite(filename,subsetAn,'Sheet11','E3:W3')%The increased values of column D are being
placed into columns E and F
InputValues=subsetAn;

% % sheet = 'Sheet11'; %sheet name
% % xlRange = 'D3;%specify the column whose values will be read into the OuputValues table
% % OutputValues = xlsread(filename, sheet,xlRange)

% save allInputsandOutputs
```

7.3 Results

- The following results shows the effect of various process variables on the production of sulphuric acid.
- Various other results show the effect of process variables on numerous other output variables.

1) Effect of Air Flow rate on Sulphuric Acid Composition

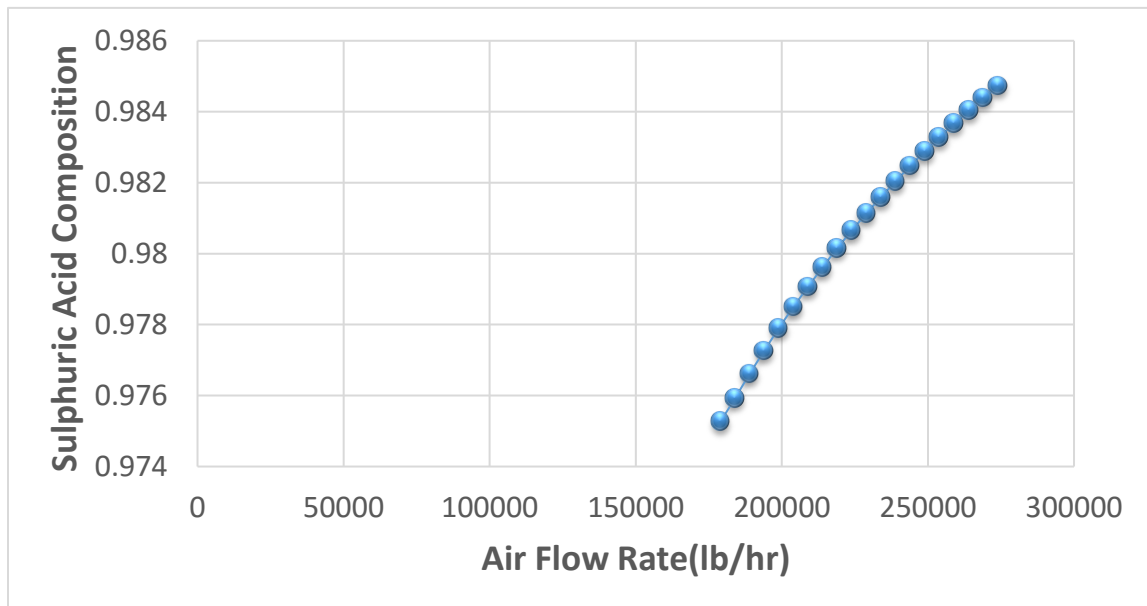

Figure 15 Effect of Air Flow rate on Sulphuric Acid Composition

The following graph shows an increase in the Sulphuric acid composition as the flow rate of air is increased. It can be seen prominently that the appropriate point where sulphuric acid composition is 98%, the air flow rate is 224000 lb/hr.

2) Effect of sulphur composition on Sulphuric acid flow rate

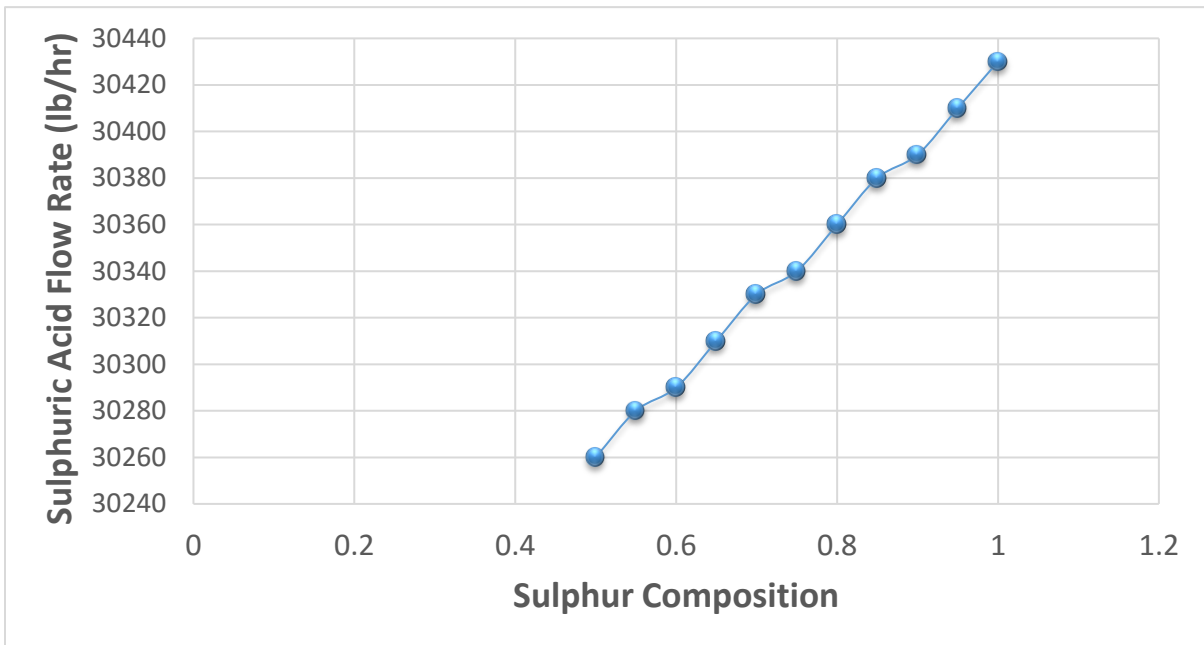

Figure 16 Effect of sulphur composition on Sulphuric acid flow rate

Following graph shows the effect of composition of sulphur on the sulphuric acid flow rate. Required 130 ton/day is produced when the sulphur composition is 1.

3) Effect of Absorber temperature on Sulphuric Acid Composition

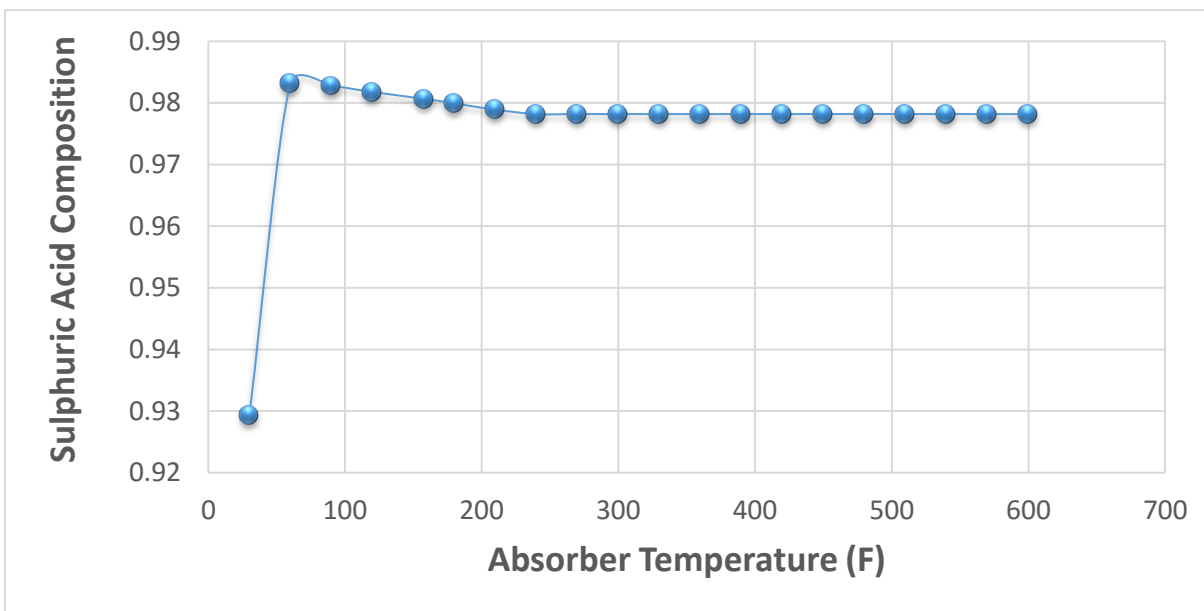

Figure 17 Effect of Absorber temperature on Sulphuric Acid Composition

Absorption is dominantly mass transfer operation therefore, temperature does not affect the output very significantly. Sulphuric acid composition is nearly constant at all temperatures. The abrupt change in the initial value is due to the design considerations of absorber.

4) Effect of temperature on Reactor Conversion

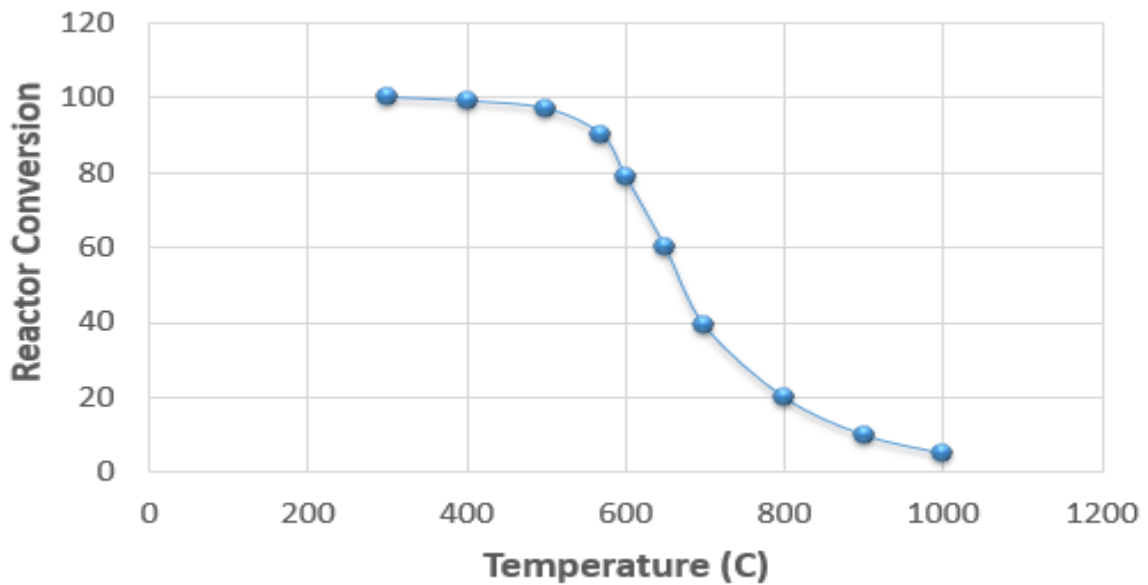

Figure 18 Effect of temperature on Reactor Conversion

As shown in the graph above, Reactor Conversion decreases as the temperature is increased from 450 °C. This shows that the required conversion i.e. 99.5% is only achieved when temperature is kept at 450 °C. So, Temperature i.e. 450 °C is the optimum temperature for the reactor.

5) Effect of Air temperature on Sulphuric acid composition

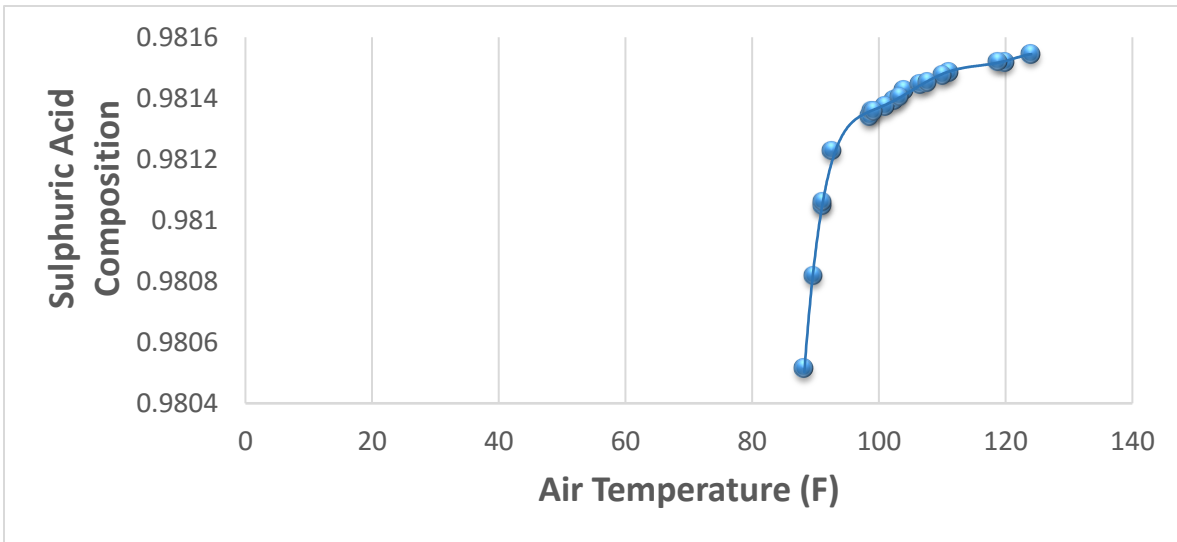

Figure 19 Effect of Air temperature on Sulphuric acid composition

Increasing the temperature of air also has an increasing behavior on the sulphuric acid composition. The required composition i.e. 98% is achieved only when the temperature of air is around 100 °C.

6) Effect of Reactor Pressure on Sulphuric Acid Composition

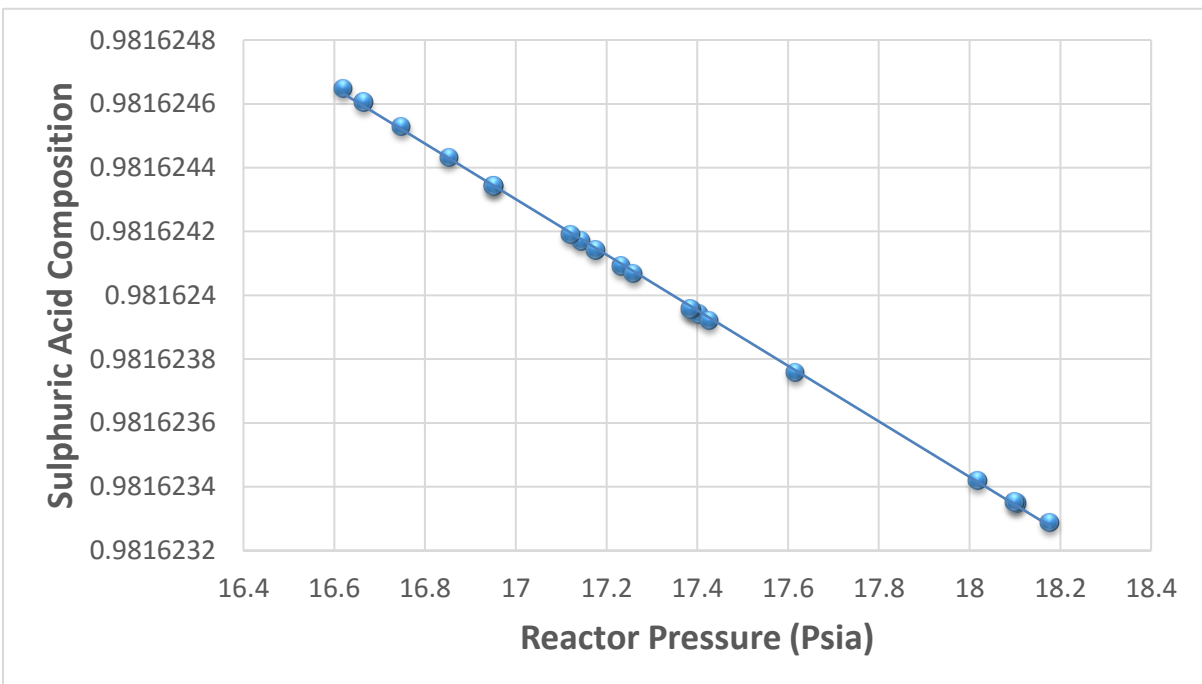

Figure 20 Effect of Reactor Pressure on Sulphuric Acid Composition

Reactor Pressure has a very negligible or insignificant effect on the sulphuric acid composition.

7) Effect of sulphur flow rate on sulphuric acid composition

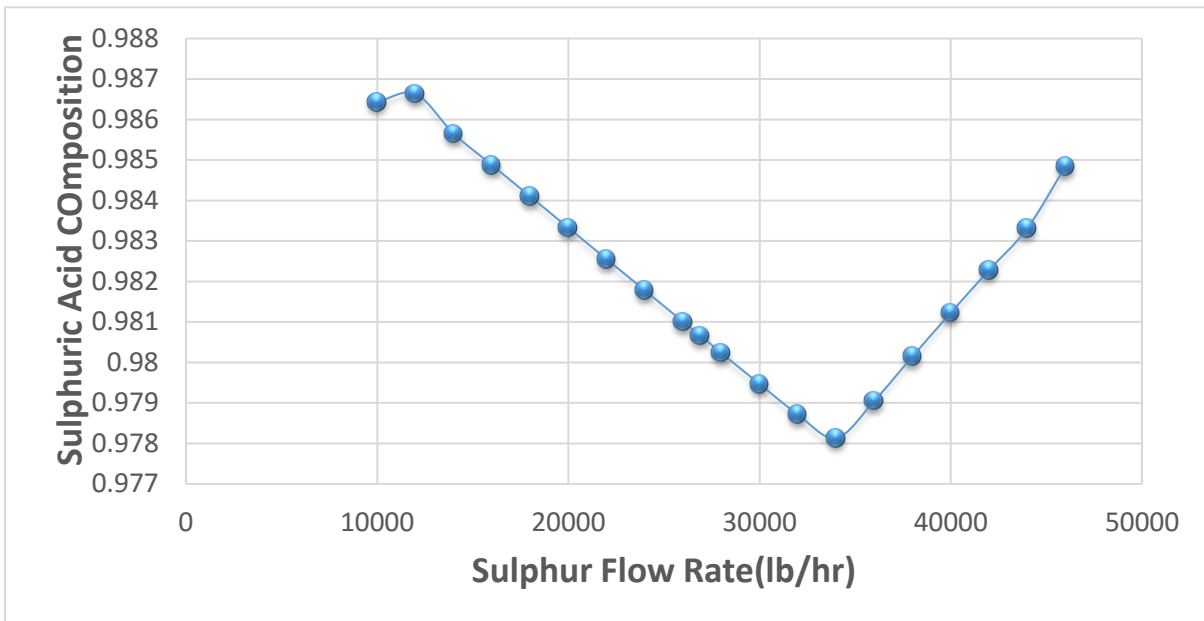

Figure 21 Effect of sulphur flow rate on sulphuric acid composition

Sulphur Flow rate VS Sulphuric acid composition has a very vague behavior. Initially, increasing the flow rate causes a decrease in composition but after a certain point, the composition starts to rise. In our simulation model 27000 lb/hr of sulphur flow rate has been used to produce required composition of sulphuric acid composition.

Chapter 8: Process Control

8.1 Introduction

Process has been demonstrated on the reactor and heat exchanger. Temperature and Flow Controls has been applied.

This type of controller work on the principle of feedback control system. In which at the output variable is measured by a sensor compared to the required value. If the error is negative or positive the controller adjusts the valve respectively. These feedback controllers contain of three parts:

- Transducer/Sensor
- a Controller
- Process system/process plant.

Reactor

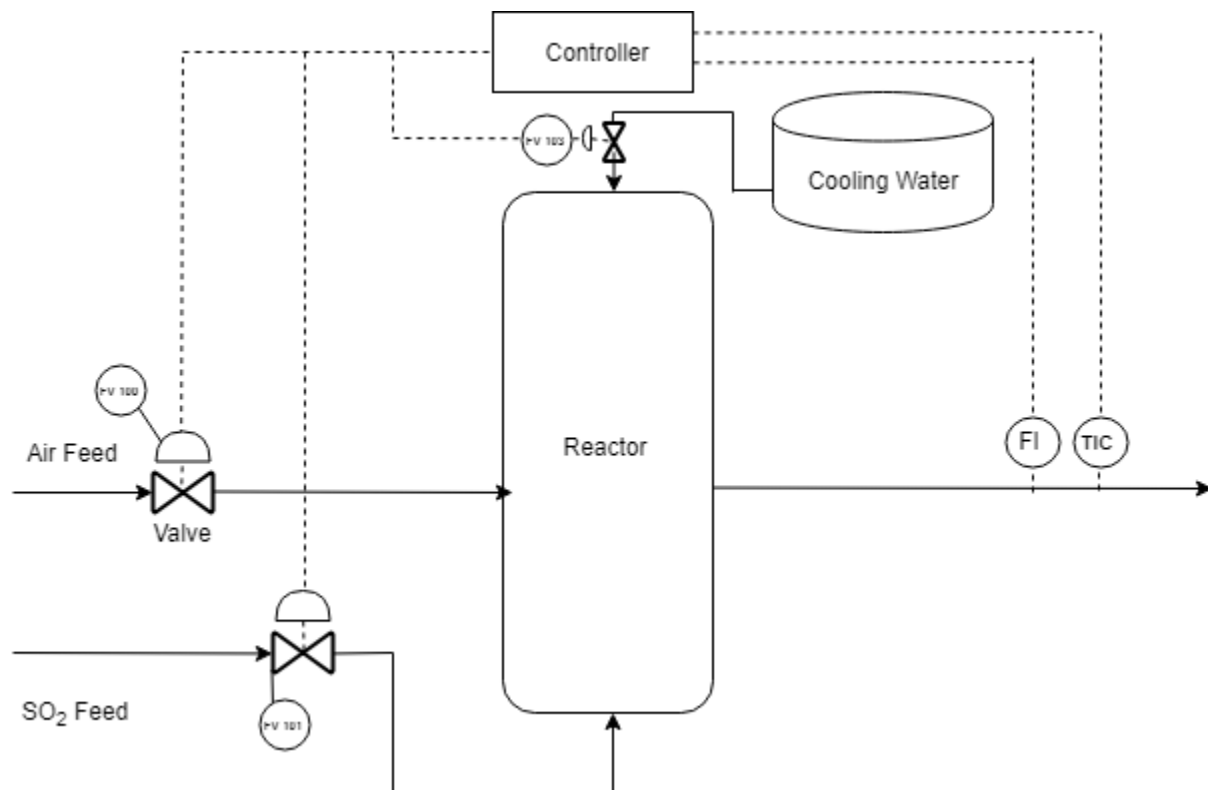

Figure 22 Process Control Reactor

Heat Exchanger

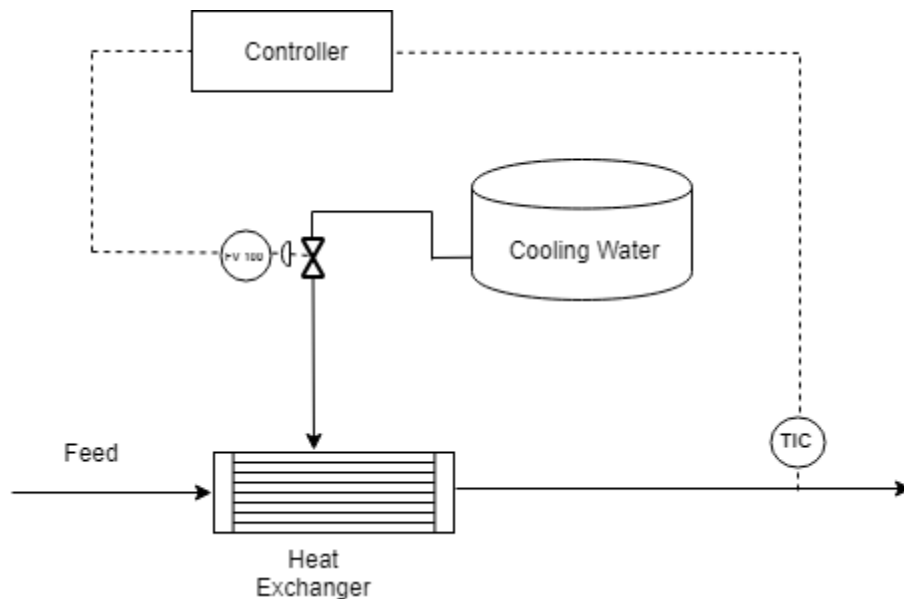

Figure 23 Process Control Heat Exchanger

8.2 General Explanation

Temperature Controller: The sensor will detect a change or increase in heat content or temperature of product stream. The controller will adjust amount of cooling water to cool or bring back the product to required temperature. Temperature is very critical here since elevated temperature may affect the reaction kinetics and also may damage the reactor equipment.

Flow Controller: If there is a change in the flow of feed or product then the controller will detect the deviation and open/close the valve according to the requirement. The sensor will detect a change or deduction in flow of product stream i.e. SO_3 . The controller will adjust the flow of Air into the reactor to enhance the flow of SO_3 as per requirement by increasing the flow automatically or set off the alarms to warn the operators to take any manual action.

Chapter 9: HAZOP Analysis

HAZOP Analysis has been carried on two of the equipments used in the production of sulphuric acid.

- I. Absorber
- II. Reactor

Key Words

- No
- More
- Less
- Part of
- Other than

Table 25 HAZOP Analysis on Absorber

Guide Word	Parameter	Deviation	Possible causes	Consequences	Action Required
No	Flow	No flow to absorber column	Blockage of pipeline Valve Failure occurred Failure of flow in previous units	High liquid holdup in the column V/L is lower than required	Installation of a level controller in alongside alarms in case excessive liquid holdup occurs
More		More flow to absorber column	FCV fails open Valve left open by operator	Flooding High pressure drop across column	Flow controller at inlet Regular inspection of valves
Less		Less flow to absorber column	Leakage in pipe Valve partially open	V/L ratio is lower than required Inefficient separation	Regulate inspection of transfer line Install low level alarms
More	Pressure	High pressure of inlet stream	FCV closes while pump is running Malfunctioning of valve	Transfer line subjected to full pump delivery or surge pressure Breakage of the packing or bursting of column	Installation of pressure relief valve Install kickback on pump Installing PCV at inlet

Less		Low pressure of inlet stream	There is a malfunction of pressure regulating valve	Leads to abnormal pressure and temperature in column Leads to improper separation	Pressure relief valve installation Using differential pressure control to ensure safe limit
More	Temperature	High temperature of inlet stream	Excess flow of heated raw material Disturbed rate of reaction	Increased temperature in column leading to excess pressure build - up	Ensure there is adequate warning of high temperature Pressure relief valves
Less		Low temperature of inlet stream	Low temperature in column	Incomplete reaction due to change in reaction kinetics	Installation of temperature controls

Table 26 HAZOP Analysis on Reactor

Guide word	Deviation	Consequences	Possible causes	Action required
No	NO O ₂ FLOW	<ul style="list-style-type: none"> ○ No product formed (SO₃) ○ Excess SO₂ in the reactor 	<ul style="list-style-type: none"> ○ Valve closed by operator ○ Line blockage ○ Pipe rupture ○ Equipment failure 	<ul style="list-style-type: none"> ○ Shut down action required ○ Ensure good communication with emergency operator ○ Implying regular

				inspection of transfer lines
Less	LESS O ₂ FLOW	<ul style="list-style-type: none"> ○ Unconverted reactants SO₂ ○ Product specifications not met 	<ul style="list-style-type: none"> ○ Valve is partially closed ○ Leak in pipe 	<ul style="list-style-type: none"> ○ Automatic closure of valve on loss of flow ○ Installation of Flow control valves ○ Regular inspection of transfer line ○ Recycling of unconverted reactant to some temporary storage
More	MORE O ₂ FLOW	<ul style="list-style-type: none"> ○ Pressure increases in the system ○ Temperature may fall and change reaction kinetics 	<ul style="list-style-type: none"> ○ Excessive pump speed ○ Flow control valves may fail 	<ul style="list-style-type: none"> ○ Install high level alarms ○ Regular inspection of pump motors ○ LCV inspection
Part of	Normal flow of decreased concentration of O ₂	<ul style="list-style-type: none"> ○ Composition of product will alter due to impurity 	<ul style="list-style-type: none"> ○ Possible failure of the air pump equipment 	<ul style="list-style-type: none"> ○ Checking O₂ supply equipment after charging ○ Inspection of the pump design and

		<ul style="list-style-type: none"> ○ Un-reacted raw material ○ Dissipation of the reactor mixture 	<ul style="list-style-type: none"> ○ Environmental conditions/ polluted air 	<ul style="list-style-type: none"> associated pipelines ○ Immediate communication with the supervisors
Other Than	Material flow other than O ₂ in Line.	<ul style="list-style-type: none"> ○ Product may be corroded if corrosive material ○ Poisoning of catalyst 	<ul style="list-style-type: none"> ○ Environmental issues (main source of oxygen) ○ Equipment failure ○ Flange leaks 	<ul style="list-style-type: none"> ○ Shut down of equipment ○ Consultation with the supervisors and operators ○ Inspection of the equipment

Chapter 10: Conclusion

- Desired Simulation of Sulphuric Acid Plant has been completed successfully. Aspen HYSYS V8.8 has been used successfully for the design of all sulfuric acid subprocesses. Real plant data and theoretical data for maximum percent SO₂ oxidized material and energy streams agree very well with the simulation results. The developed simulation model can also be used as a guidance on process and economic understanding and a basis on which more sophisticated plant design and process equipment design models can be specified.
- 98-98.5% Sulphuric acid is being produced through the chemisorption process of sulphur trioxide and water. The formation of oleum as an intermediate has not been demonstrated in our model. Instead, we have directly converted sulphur trioxide into sulphuric acid through its reaction with water in two subsequent absorbers.
- 99.5% conversion is being achieved in the Plug Flow Reactor. Kinetics from literature have been successfully used to achieve the required conversion in the plug flow reactor. In addition to this, reactor parameters such as volume of reactor and catalyst specifications have been evaluated and discussed in the equipment design section.
- Absorber Temperature, Reactor Temperature and Feed Composition affects the overall production.
- Temperature has significant effect on reactor conversion and it has been demonstrated in the sensitivity analysis.
- Fixed Capital Cost of the plant is \$4.3 M and payback period is 2.5 years.

Chapter 11: References

- Navin G. Ashar, Kiran R. Golwalkar. "A Practical Guide to the Manufacture of Sulfuric Acid, Oleums, and Sulfonating Agents", Springer Nature, 2013
- Anton A. Kiss, Costin S. Bildea, Johan Frievink "Dynamic modeling and process optimization of an industrial sulfuric acid plant", Chemical Engineering Journal, 201
- "Hazard Identification", Elsevier BV, 2005
- A.O. Oni, D.A. Fadare, S. Sharma, G.P. Rangaiah. "Multi-objective optimization of a double contact double absorption sulphuric acid plant for cleaner operation", Journal of Cleaner Production, 201
- Booklet_nr_3_Production_of_Sulphuric_Acid.pdf
- COM2010_Acid_SC1_Plant_Fundamentals_Louie.pdf
- 999SO2oxoverVOxcatalysts.pdf
- Production_of_Sulfuric_acid.pdf
- Sulfuric_Acid_Production.pdf
- Sulphuric_acid_production-Installation_1.pdf
- mc2-2014-student-notes-y12-chemistry-sulfuric-final.pdf
- unit%201.pdf
- sulfuric-acid-manufacture-davenport-king.pdf
- Dr.N.K. Patel. "Sulfuric acid"
- Smarthveer Sidana. "Sulfuric Acid Production Using Catalytic Oxidation."
- 264041530_Aspen-Hysys_Simulation_Of_Sulfuric_Acid_Plant

Turnitin Originality Report

- Processed on: 25-May-2019 05:45 PKT
 - ID: 1135630500
 - Word Count: 9037
 - Submitted: 2
- Finalized Report By Muhammad Ahmad Anwar

Similarity Index

17%

Similarity by Source

Internet Sources:

7%

Publications:

7%

Student Papers:

12%

[include quoted](#) [include bibliography](#) [exclude small matches](#) [download](#) [print](#)

mode: Change mode

2% match (Internet from 26-Nov-2017)

<http://www.springer.com>

1% match (publications)

[Anton A. Kiss, Costin S. Bildea, Johan Grievink. "Dynamic modeling and process optimization of an industrial sulfuric acid plant", Chemical Engineering Journal, 2010](#)

1% match (Internet from 21-Jan-2010)

<http://www.aiche-cf.org>

1% match (Internet from 18-Oct-2018)

<http://docplayer.net>

1% match (Internet from 04-Jan-2014)

<http://cheme.nl>

1% match (publications)

[Navin G. Ashar, Kiran R. Golwalkar. "A Practical Guide to the Manufacture of Sulfuric Acid, Oleums, and Sulfonating Agents", Springer Nature, 2013](#)

1% match (student papers from 28-Mar-2019)

[Submitted to University of Newcastle upon Tyne on 2019-03-28](#)

1% match (student papers from 29-Aug-2009)

[Submitted to University of Teesside on 2009-08-29](#)

1% match (Internet from 03-May-2014)

<http://www.saimm.co.za>

<1% match (Internet from 16-Jan-2015)

<http://www.wvcoal.com>

<1% match (student papers from 18-Apr-2016)

[Submitted to University of Nottingham on 2016-04-18](#)

<1% match (student papers from 23-Jun-2017)

[Submitted to University of Cape Town on 2017-06-23](#)

<1% match (Internet from 01-Apr-2018)

<https://chemistlibrary.files.wordpress.com/2015/05/sulfuric-acid-manufacture-davenport-king.pdf>

<1% match (student papers from 06-May-2019)

[Submitted to Univerza v Ljubljani on 2019-05-06](#)

<1% match (student papers from 24-Mar-2017)

[Submitted to University of Newcastle upon Tyne on 2017-03-24](#)

<1% match (student papers from 21-Mar-2012)

[Submitted to St. Mary's Catholic College on 2012-03-21](#)
<1% match (student papers from 12-Apr-2011)

[Submitted to Royal Melbourne Institute of Technology on 2011-04-12](#)
<1% match (student papers from 16-Oct-2015)

[Submitted to Durban University of Technology on 2015-10-16](#)
<1% match (student papers from 15-Apr-2011)

[Submitted to Royal Melbourne Institute of Technology on 2011-04-15](#)
<1% match (student papers from 28-Aug-2014)

[Submitted to University College London on 2014-08-28](#)
<1% match (student papers from 02-Dec-2015)

[Submitted to Michigan State University on 2015-12-02](#)
<1% match (Internet from 17-Apr-2010)

<http://www.icaai.org>
<1% match (student papers from 07-May-2018)

[Submitted to Segi University College on 2018-05-07](#)
<1% match (student papers from 17-Apr-2011)

[Submitted to Royal Melbourne Institute of Technology on 2011-04-17](#)
<1% match (Internet from 18-Oct-2018)

<http://www.preqveca.ru>
<1% match (student papers from 22-Apr-2013)

[Submitted to The University of Manchester on 2013-04-22](#)
<1% match (student papers from 08-Nov-2010)

[Submitted to North West University on 2010-11-08](#)
<1% match (publications)

[Gowariker. "S", The Fertilizer Encyclopedia, 01/05/2008](#)
<1% match (student papers from 08-Apr-2011)

[Submitted to The University of Manchester on 2011-04-08](#)
<1% match (student papers from 27-Feb-2019)

[Submitted to Higher Education Commission Pakistan on 2019-02-27](#)
<1% match (publications)

[A. Nodehi, M. A. Mousavian. "Simulation and Optimization of an Adiabatic Multi-Bed Catalytic Reactor for the Oxidation of SO₂", Chemical Engineering & Technology, 2007](#)
<1% match (student papers from 08-Apr-2011)

[Submitted to The University of Manchester on 2011-04-08](#)
<1% match (student papers from 24-Aug-2016)

[Submitted to University of Witwatersrand on 2016-08-24](#)
<1% match (Internet from 21-Aug-2010)

<http://www.scribd.com>
<1% match (Internet from 01-Sep-2016)

<https://www.scribd.com/document/283798049/Isomerization-of-Light-Naphtha-Full-and-Final>
<1% match (student papers from 21-May-2007)

[Submitted to University of Leeds on 2007-05-21](#)
<1% match (student papers from 23-Apr-2007)

[Submitted to City University of Hong Kong on 2007-04-23](#)
<1% match (student papers from 21-Oct-2009)

[Submitted to University of Malaya on 2009-10-21](#)
<1% match (student papers from 22-Dec-2017)

[Submitted to University College London on 2017-12-22](#)
<1% match (student papers from 20-Dec-2016)

[Submitted to Caledonian College of Engineering on 2016-12-20](#)
<1% match (Internet from 06-Sep-2017)

<http://www.che.ntu.edu.tw>
<1% match (student papers from 11-Jun-2018)

[Submitted to Harare Institute of TEchnology on 2018-06-11](#)
<1% match (student papers from 04-Jun-2010)

[Submitted to University of Newcastle upon Tyne on 2010-06-04](#)

<1% match (student papers from 19-Mar-2019)
[Submitted to University of Birmingham on 2019-03-19](#)

<1% match (student papers from 06-May-2019)
[Submitted to Los Altos High School on 2019-05-06](#)

<1% match (student papers from 28-Mar-2014)
[Submitted to University of Birmingham on 2014-03-28](#)

<1% match (student papers from 05-Apr-2019)
[Submitted to International School of Milan on 2019-04-05](#)

<1% match (student papers from 19-May-2008)
[Submitted to University of Leeds on 2008-05-19](#)

<1% match (student papers from 31-Oct-2011)
[Submitted to National University of Singapore on 2011-10-31](#)

<1% match (student papers from 21-Apr-2013)
[Submitted to The University of Manchester on 2013-04-21](#)

<1% match (student papers from 05-Sep-2016)
[Submitted to Higher Education Commission Pakistan on 2016-09-05](#)

<1% match (Internet from 19-Sep-2018)
<http://faculty.kfupm.edu.sa>

<1% match (student papers from 16-May-2014)
[Submitted to University of Newcastle upon Tyne on 2014-05-16](#)

<1% match (student papers from 12-Sep-2011)
[Submitted to University of Melbourne on 2011-09-12](#)

<1% match (student papers from 08-Mar-2015)
[Submitted to Imperial College of Science, Technology and Medicine on 2015-03-08](#)

<1% match (Internet from 19-May-2016)
<http://documents.mx>

<1% match (student papers from 22-Dec-2016)
[Submitted to Segi University College on 2016-12-22](#)

<1% match (student papers from 28-Feb-2017)
[Submitted to University of Hull on 2017-02-28](#)

<1% match (student papers from 15-Jul-2015)
[Submitted to Higher Education Commission Pakistan on 2015-07-15](#)

<1% match (student papers from 26-Nov-2017)
[Submitted to International School of Milan on 2017-11-26](#)

<1% match (student papers from 03-May-2011)
[Submitted to Royal Melbourne Institute of Technology on 2011-05-03](#)

<1% match (student papers from 03-Dec-2012)
[Submitted to University of Oklahoma on 2012-12-03](#)

<1% match (student papers from 03-Mar-2018)
[Submitted to South Bank University on 2018-03-03](#)

<1% match (Internet from 27-Mar-2019)
<https://open.library.ubc.ca/cIRcle/collections/ubctheses/831/items/1.0054611>

<1% match (publications)
[A.O. Oni, D.A. Fadare, S. Sharma, G.P. Rangaiah. "Multi-objective optimisation of a double contact double absorption sulphuric acid plant for cleaner operation", Journal of Cleaner Production, 2018](#)

<1% match (student papers from 16-Aug-2018)
[Submitted to Copperbelt University on 2018-08-16](#)

<1% match (student papers from 12-Dec-2018)
[Submitted to Universiti Teknologi Petronas on 2018-12-12](#)

<1% match (student papers from 04-Feb-2013)
[Submitted to University of Sheffield on 2013-02-04](#)

<1% match (student papers from 31-Mar-2017)
[Submitted to The University of Manchester on 2017-03-31](#)

<1% match (student papers from 14-Apr-2011)
[Submitted to Royal Melbourne Institute of Technology on 2011-04-14](#)

<1% match (student papers from 17-May-2013)

[Submitted to University of Newcastle upon Tyne on 2013-05-17](#)
<1% match (student papers from 17-Oct-2016)

[Submitted to IIT Delhi on 2016-10-17](#)
<1% match (student papers from 30-Oct-2012)

[Submitted to North West University on 2012-10-30](#)
<1% match (student papers from 13-Sep-2009)

[Submitted to Scotch Oakburn College on 2009-09-13](#)
<1% match (student papers from 17-Apr-2011)

[Submitted to Royal Melbourne Institute of Technology on 2011-04-17](#)
<1% match (student papers from 18-Apr-2011)

[Submitted to Royal Melbourne Institute of Technology on 2011-04-18](#)
<1% match (Internet from 23-Apr-2016)

https://bibliotecas.usal.es/en/system/files/noticias/Springer_eBook_USAL.pdf
<1% match (student papers from 19-Mar-2007)

[Submitted to A.B. Paterson College on 2007-03-19](#)
<1% match (Internet from 04-Oct-2011)

<http://www.circleofblue.org>
<1% match (student papers from 02-Jun-2017)

[Submitted to University of Cape Town on 2017-06-02](#)
<1% match (student papers from 14-Dec-2018)

[Submitted to University of Leeds on 2018-12-14](#)
<1% match (student papers from 30-Apr-2010)

[Submitted to The University of Manchester on 2010-04-30](#)
<1% match (student papers from 11-Jan-2006)

[Submitted to Nanjing International School on 2006-01-11](#)
<1% match (student papers from 17-Mar-2019)

[Submitted to Technische Universiteit Delft on 2019-03-17](#)