



FIONA COBB

Structural Engineer's Pocket Book

Structural Engineer's Pocket Book

This Page Intentionally Left Blank

Structural Engineer's Pocket Book

Fiona Cobb



ELSEVIER
BUTTERWORTH
HEINEMANN

AMSTERDAM BOSTON HEIDELBERG LONDON NEW YORK OXFORD
PARIS SAN DIEGO SAN FRANCISCO SINGAPORE SYDNEY TOKYO

Elsevier Butterworth-Heinemann
Linacre House, Jordan Hill, Oxford OX2 8DP
200 Wheeler Rd, Burlington, MA 01803

First published 2004

Copyright © 2004, Fiona Cobb. All rights reserved

The right of Fiona Cobb to be identified as the author of this work has been asserted in accordance with the Copyright, Designs and Patents Act 1988

No part of this publication may be reproduced in any material form (including photocopying or storing in any medium by electronic means and whether or not transiently or incidentally to some other use of this publication) without the written permission of the copyright holder except in accordance with the provisions of the Copyright, Designs and Patents Act 1988 or under the terms of a licence issued by the Copyright Licensing Agency Ltd, 90 Tottenham Court Road, London, England W1T 4LP. Applications for the copyright holder's written permission to reproduce any part of this publication should be addressed to the publisher

Permissions may be sought directly from Elsevier's Science and Technology Rights Department in Oxford, UK:
phone: (+44) (0) 1865 843830;
fax: (+44) (0) 1865 853333;
e-mail: permissions@elsevier.co.uk.

You may also complete your request on-line via the Elsevier homepage (<http://www.elsevier.com>), by selecting 'Customer Support' and then 'Obtaining Permissions'

British Library Cataloguing in Publication Data

A catalogue record for this book is available from the British Library

Library of Congress Cataloguing in Publication Data

A catalogue record for this book is available from the Library of Congress

ISBN 0 7506 5638 7

For information on all Elsevier Butterworth-Heinemann publications visit our website at http://books.elsevier.com

Typeset by Integra Software Services Pvt. Ltd, Pondicherry, India
www.integra-india.com
Printed and bound in Great Britain

Contents

<i>Preface</i>	ix
<i>Acknowledgements</i>	xi
1 General Information	
Metric system	1
Typical metric units for UK structural engineering	2
Imperial units	3
Conversion factors	4
Measurement of angles	5
Construction documentation and procurement	6
Drawing conventions	8
Common arrangement of work sections	10
Summary of ACE conditions of engagement	11
2 Statutory Authorities and Permissions	
Planning	13
Building regulations and standards	14
Listed buildings	17
Conservation areas and Tree preservation orders	18
Archaeology and ancient monuments	19
Party Wall etc. Act	21
CDM	24
3 Design Data	
Design data checklist	25
Structural form, stability and robustness	26
Structural movement joints	29
Fire resistance periods for structural elements	30
Typical building tolerances	31
Historical use of building materials	32
Typical weights of building materials	34
Minimum imposed floor loads	38
Typical unit floor and roof loadings	41
Wind loading	43
Barrier and handrail loadings	44

Selection of materials	46
Selection of floor construction	47
Transportation	48
Temporary works toolkit	52
4 Basic and Shortcut Tools for Structural Analysis	
Load factors and limit states	55
Geometric section properties	56
Parallel axis theorem and Composite sections	60
Material properties	61
Coefficients of linear thermal expansion	64
Coefficients of friction	65
Sign conventions	66
Beam bending theory	67
Deflection limits	68
Beam bending and deflection formulae	69
Clapeyron's equations of three moments	76
Continuous beam bending formulae	78
Struts	79
Rigid frames under lateral loads	81
Plates	84
Torsion	88
Taut wires, cables and chains	89
Vibration	91
5 Geotechnics	
Geotechnics	92
Selection of foundations and retaining walls	93
Site investigation	94
Soil classification	95
Typical soil properties	96
Preliminary sizing	100
Trees and shallow foundations	109
Contaminated land	113
6 Timber and Plywood	
Timber	117
Timber section sizes	119
Laminated timber products	120
Durability and fire resistance	122
Preliminary sizing of timber elements	125

Timber design to BS 5268	127
Timber joints	135
7 Masonry	
Masonry	141
Geometry and arrangement	143
Durability and fire resistance	147
Preliminary sizing of masonry elements	148
Masonry design to BS 5628	152
Masonry design to CP111	166
Lintel design to BS 5977	168
Masonry accessories	170
8 Reinforced Concrete	
Reinforced concrete	175
Concrete mixes	177
Durability and fire resistance	179
Preliminary sizing of concrete elements	180
Reinforcement	182
Concrete design to BS 8110	185
Reinforcement bar bending to BS 8666	205
Reinforcement estimates	207
9 Structural Steel	
Structural steel	208
Mild steel section sizes and tolerances	210
Slenderness	239
Durability and fire resistance	242
Preliminary sizing of steel elements	246
Steel design to BS 5950	249
Steel design to BS 449	261
Stainless steel to BS 5950	269
10 Composite Steel and Concrete	
Composite steel and concrete	275
Preliminary sizing of composite elements	277
Composite design to BS 5950	281
11 Structural Glass	
Structural glass	284
Typical glass section sizes and thicknesses	287
Durability and fire resistance	288
Typical glass sizes for common applications	289
Structural glass design	291
Connections	293

12 Building Elements, Materials, Fixings and Fastenings

Waterproofing	295
Basement waterproofing	296
Screeds	299
Precast concrete hollowcore slabs	300
Bi-metallic corrosion	301
Structural adhesives	302
Fixings and fastenings	304
Cold weather working	307
Effect of fire on construction materials	308
Aluminium	310

13 Useful Mathematics 314

<i>Useful Addresses</i>	320
<i>Further Reading</i>	331
<i>Sources</i>	336
<i>Index</i>	339

Preface

As a student or graduate engineer it is difficult to source basic design data. Having been unable to find a compact book containing this information, I decided to compile my own after seeing a pocket book for architects. I realised that a *Structural Engineer's Pocket Book* might be useful for other engineers and construction industry professionals. My aim has been to gather useful facts and figures for use in preliminary design in the office, on site or in the IStructE Part 3 exam, based on UK conventions.

The book is not intended as a textbook; there are no worked examples and the information is not prescriptive. Design methods from British Standards have been included and summarized, but obviously these are not the only way of proving structural adequacy. Preliminary sizing and shortcuts are intended to give the engineer a 'feel' for the structure before beginning design calculations. All of the data should be used in context, using engineering judgement and current good practice. Where no reference is given, the information has been compiled from several different sources.

Despite my best efforts, there may be some errors and omissions. I would be interested to receive any comments, corrections or suggestions on the content of the book by email at sepb@inmyopinion.co.uk. Obviously, it has been difficult to decide what information can be included and still keep the book a compact size. Therefore any proposals for additional material should be accompanied by a proposal for an omission of roughly the same size – the reader should then appreciate the many dilemmas that I have had during the preparation of the book! If there is an opportunity for a second edition, I will attempt to accommodate any suggestions which are sent to me and I hope that you find the *Structural Engineer's Pocket Book* useful.

Fiona Cobb

This Page Intentionally Left Blank

Acknowledgements

Thanks to the following people and organizations:

Price & Myers for giving me varied and interesting work, without which this book would not have been possible! Paul Batty, David Derby, Sarah Fawcus, Step Haiselden, Simon Jewell, Chris Morrisey, Mark Peldmanis, Sam Price, Helen Remordina, Harry Stocks and Paul Toplis for their comments and help reviewing chapters. Colin Ferguson, Derek Fordyce, Phil Gee, Alex Hollingsworth, Paul Johnson, Deri Jones, Robert Myers, Dave Rayment and Andy Toohey for their help, ideas, support, advice and/or inspiration at various points in the preparation of the book. Renata Corbani, Rebecca Rue and Sarah Hunt at Elsevier. The technical and marketing representatives of the organizations mentioned in the book. Last but not least, thanks to Jim Cobb, Elaine Cobb, Iain Chapman for his support and the loan of his computer and Jean Cobb for her help with typing and proof reading.

This Page Intentionally Left Blank

1

General Information

Metric system

The most universal system of measurement is the International System of Units, referred to as SI, which is an absolute system of measurement based upon the fundamental quantities of mass, length and time, independent of where the measurements are made. This means that while mass remains constant, the unit of force (newton) will vary with location. The acceleration due to gravity on earth is 9.81 m/s^2 .

The system uses the following basic units:

Length	m	metre
Time	s	second
Luminous intensity	cd	candela
Quantity/substance	mol	mole (6.02×10^{23} particles of substance (Avogadro's number))
Mass	kg	kilogram
Temperature	K	kelvin ($0^\circ\text{C} = 273^\circ\text{K}$)
Unit of plane angle	rad	radian

The most commonly used prefixes in engineering are:

giga	G	1 000 000 000	1×10^9
mega	M	1 000 000	1×10^6
kilo	k	1000	1×10^3
centi	c	0.01	1×10^{-2}
milli	m	0.001	1×10^{-3}
micro	μ	0.000001	1×10^{-6}
nano	n	0.000000001	1×10^{-9}

The base units and the prefixes listed above, imply a system of supplementary units which forms the convention for noting SI measurements, such as the pascal for measuring pressure where $1 \text{ Pa} = 1 \text{ N/m}^2$ and $1 \text{ MPa} = 1 \text{ N/mm}^2$.

Typical metric units for UK structural engineering

Mass of material	kg
Density of material	kg/m ³
Bulk density	kN/m ³
Weight/force/point load	kN
Bending moment	kNm
Load per unit length	kN/m
Distributed load	kN/m ²
Wind loading	kN/m ²
Earth pressure	kN/m ²
Stress	N/mm ²
Modulus of elasticity	kN/mm ²
Deflection	mm
Span or height	m
Floor area	m ²
Volume of material	m ³
Reinforcement spacing	mm
Reinforcement area	mm ² or mm ² /m
Section dimensions	mm
Moment of inertia	cm ⁴ or mm ⁴
Section modulus	cm ³ or mm ³
Section area	cm ² or mm ²
Radius of gyration	cm or mm

Imperial units

In the British Imperial System the unit of force (pound) is defined as the weight of a certain mass which remains constant, independent of the gravitational force. This is the opposite of the assumptions used in the metric system where it is the mass of a body which remains constant. The acceleration due to gravity is 32.2 ft/s^2 , but this is rarely needed. While on the surface it appears that the UK building industry is using metric units, the majority of structural elements are produced to traditional Imperial dimensions which are simply quoted in metric.

The standard units are:

Length

1 mile	= 1760 yards
1 furlong	= 220 yards
1 yard (yd)	= 3 feet
1 foot (ft)	= 12 inches
1 inch (in)	= 1/12 foot

Area

1 sq. mile	= 640 acres
1 acre	= 4840 sq. yd
1 sq. yd	= 9 sq. ft
1 sq. ft	= 144 sq. in
1 sq. in	= 1/144 sq. ft

Weight

1 ton	= 2240 pounds
1 hundredweight (cwt)	= 112 pounds
1 stone	= 14 pounds
1 pound (lb)	= 16 ounces
1 ounce	= 1/16 pound

Capacity

1 bushel	= 8 gallons
1 gallon	= 4 quarts
1 quart	= 2 pints
1 pint	= 1/2 quart
1 fl. oz	= 1/20 pint

Volume

1 cubic yard	= 27 cubic feet
1 cubic foot	= 1/27 cubic yards
1 cubic inch	= 1/1728 cubic feet

Nautical measure

1 nautical mile	= 6080 feet
1 cable	= 600 feet
1 fathom	= 6 feet

Conversion factors

Given the dual use of SI and British Imperial Units in the UK construction industry, quick and easy conversion between the two systems is essential. A selection of useful conversion factors are:

Mass	1 kg	=	2.205 lb	1 lb	=	0.4536 kg
	1 tonne	=	0.9842 tons	1 ton	=	1.016 tonnes
Length	1 mm	=	0.03937 in	1 in	=	25.4 mm
	1 m	=	3.281 ft	1 ft	=	0.3048 m
	1 m	=	1.094 yd	1 yd	=	0.9144 m
Area	1 mm ²	=	0.00153 in ²	1 in ²	=	645.2 mm ²
	1 m ²	=	10.764 ft ²	1 ft ²	=	0.0929 m ²
	1 m ²	=	1.196 yd ²	1 yd ²	=	0.8361 m ²
Volume	1 mm ³	=	0.000061 in ³	1 in ³	=	16 390 mm ³
	1 m ³	=	35.32 ft ³	1 ft ³	=	0.0283 m ³
	1 m ³	=	1.308 yd ³	1 yd ³	=	0.7646 m ³
Density	1 kg/m ³	=	0.06242 lb/ft ³	1 lb/ft ³	=	16.02 kg/m ³
	1 tonne/m ³	=	0.7524 ton/yd ³	1 ton/yd ³	=	1.329 tonne/m ³
Force	1 N	=	0.2248 lbf	1 lbf	=	4.448 N
	1 kN	=	0.1004 tonf	1 tonf	=	9.964 kN
Stress and pressure	1 N/mm ²	=	145 lbf/in ²	1 lbf/in ²	=	0.0068 N/mm ²
	1 N/mm ²	=	0.0647 tonf/in ²	1 tonf/in ²	=	15.44 N/mm ²
	1 N/m ²	=	0.0208 lbf/ft ²	1 lbf/ft ²	=	47.88 N/m ²
	1 kN/m ²	=	0.0093 tonf/ft ²	1 tonf/ft ²	=	107.3 kN/m ²
Line loading	1 kN/m	=	68.53 lbf/ft	1 lbf/ft	=	0.0146 kN/m
	1 kN/m	=	0.03059 tonf/ft	1 tonf/ft	=	32.69 kN/m
Moment	1 Nm	=	0.7376 lbf ft	1 lbf ft	=	1.356 Nm
Modulus of elasticity	1 N/mm ²	=	145 lbf/in ²	1 lbf/in ²	=	6.8 × 10 ⁻³ N/mm ²
	1 kN/mm ²	=	145 032 lbf/in ²	1 lbf/in ²	=	6.8 × 10 ⁻⁶ kN/mm ²
Section modulus	1 mm ³	=	61.01 × 10 ⁻⁶ in ³	1 in ³	=	16 390 mm ³
	1 cm ³	=	61.01 × 10 ⁻³ in ³	1 in ³	=	16.39 cm ³
Second moment of area	1 mm ⁴	=	2.403 × 10 ⁻⁶ in ⁴	1 in ⁴	=	416 200 mm ⁴
	1 cm ⁴	=	2.403 × 10 ⁻² in ⁴	1 in ⁴	=	41.62 cm ⁴
Temperature	x°C	=	[(1.8x + 32)]°F	y°F	=	[(y - 32)/1.8]°C

Measurement of angles

There are two systems for the measurement of angles commonly used in the UK.

English system

The English or sexagesimal system which is universal:

$$1 \text{ right angle} = 90^\circ \text{ (degrees)}$$

$$1^\circ \text{ (degree)} = 60' \text{ (minutes)}$$

$$1' \text{ (minute)} = 60'' \text{ (seconds)}$$

International system

Commonly used for the measurement of plane angles in mechanics and mathematics, the radian is a constant angular measurement equal to the angle subtended at the centre of any circle, by an arc equal in length to the radius of the circle.

$$\pi \text{ radians} = 180^\circ \text{ (degrees)}$$

$$1 \text{ radian} = \frac{180^\circ}{\pi} = \frac{180^\circ}{3.1416} = 57^\circ 17' 44''$$

Equivalent angles in degrees and radians and trigonometric ratios

Angle θ in radians	0	$\frac{\pi}{6}$	$\frac{\pi}{4}$	$\frac{\pi}{3}$	$\frac{\pi}{2}$
Angle θ in degrees	0°	30°	45°	60°	90°
$\sin \theta$	0	$\frac{1}{2}$	$\frac{1}{\sqrt{2}}$	$\frac{\sqrt{3}}{2}$	1
$\cos \theta$	1	$\frac{\sqrt{3}}{2}$	$\frac{1}{\sqrt{2}}$	$\frac{1}{2}$	0
$\tan \theta$	0	$\frac{1}{\sqrt{3}}$	1	$\sqrt{3}$	∞

Construction documentation and procurement

Construction documentation

The members of the design team each produce drawings, specifications and schedules which explain their designs to the contractor. The drawings set out in visual form how the design is to look and how it is to be put together. The specification describes the design requirements for the materials and workmanship, and additional schedules set out sizes and co-ordination information not already covered in the drawings or specification. The quantity surveyor uses all of these documents to prepare bills of quantities, which are used to help break down the cost of the work. The drawings, specifications, schedules and bills of quantities form the tender documentation. 'Tender' is when the bills and design information are sent out to contractors for their proposed prices and construction programmes. 'Procurement' simply means the method by which the contractor is to be chosen and employed, and how the building contract is managed.

Traditional procurement

Once the design is complete, tender documentation is prepared and sent out to the selected contractors (three to six depending on how large the project is) who are normally only given a month to absorb all the information and return a price for the work. Typically, a main contractor manages the work on site and has no labour of his own. The main contractor gets prices for the work from subcontractors and adds profit and preliminaries before returning the tenders to the design team. The client has the option to choose any of the tenderers, but the selection in the UK is normally on the basis of the lowest price. The client will be in contract with the main contractor, who in turn is in contract with the subcontractors. The architect normally acts as the contract administrator for the client. The tender process is sometimes split to overlap part of the design phase with a first stage tender and to achieve a quicker start on site than with a conventional tender process.

Construction management

Towards the end of the design process, the client employs a management contractor to oversee the construction. The management contractor takes the tender documentation, splits the information into packages and chooses trade contractors (a different name for a subcontractor) to tender for the work. The main differences between construction management and traditional procurement are that the design team can choose which trade contractors are asked to price and the trade contractors are directly contracted to the client. While this type of contractual arrangement can work well for straightforward buildings it is not ideal for refurbishment or very complex jobs where it is not easy to split the job into simple 'trade packages'.

Design and Build

This procurement route is preferred by clients who want cost security and it is generally used for projects which have economy, rather than quality of design, as the key requirement. There are two versions of Design and Build. This first is for the design team to work for the client up to the tender stage, before being 'novated' to work for the main contractor. (A variant of this is a fixed sum contract where the design team remain employed by the client, but the cost of the work is fixed.) The second method is when the client tenders the project to a number of consortia on an outline description and specification. A consortium is typically led by a main contractor who has employed a design team. This typically means that the main contractor has much more control over the construction details than with other procurement routes.

Partnering

Partnering is difficult to define, and can take many different forms, but often means that the contractor is paid to be included as a member of the design team, where the client has set a realistic programme and budget for the size and quality of the building required. Partnering generally works best for teams who have worked together before, where the team members are all selected on the basis of recommendation and past performance. Ideally the contractor can bring his experience in co-ordinating and programming construction operations to advise the rest of the team on choice of materials and construction methods. Normally detailing advice can be more difficult as main contractors tend to rely on their subcontractors for the fine detail. The actual contractual arrangement can be as any of those previously mentioned and sometimes the main contractor will share the risk of costs increases with the client on the basis that they can take a share of any cost savings.

Drawing conventions

Drawing conventions provide a common language so that those working in the construction industry can read the technical content of the drawings. It is important for everyone to use the same drawing conventions, to ensure clear communication. Construction industry drawing conventions are covered by BS EN ISO 7519 which takes over from the withdrawn BS 1192 and BS 308.

A drawing can be put to its best use if the projections/views are carefully chosen to show the most information with the maximum clarity. Most views in construction drawings are drawn orthographically (drawings in two dimensions), but isometric (30°) and axonometric (45°) projections should not be forgotten when dealing with complicated details. Typically drawings are split into: location, assembly and component. These might be contained on only one drawing for a small job. Drawing issue sheets should log issue dates, drawing revisions and reasons for the issue.

Appropriate scales need to be picked for the different type of drawings:

Location/site plans – Used to show site plans, site levels, roads layouts, etc. Typical scales: 1:200, 1:500 and up to 1:2500 if the project demands.

General arrangement (GA) – Typically plans, sections and elevations set out as orthographic projections (i.e. views on a plane surface). The practical minimum for tender or construction drawings is usually 1:50, but 1:20 can also be used for more complicated plans and sections.

Details – Used to show the construction details referenced on the plans to show how individual elements or assemblies fit together. Typical scales: 1:20, 1:10, 1:5, 1:2 or 1:1

Structural drawings should contain enough dimensional and level information to allow detailing and construction of the structure.

For small jobs or early in the design process, 'wobbly line' hand drawings can be used to illustrate designs to the design team and the contractor. The illustrations in this book show the type of freehand scale drawings which can be done using different line thicknesses and without using a ruler. These sorts of sketches can be quicker to produce and easier to understand than computer drawn information, especially in the preliminary stages of design.

Line thicknesses

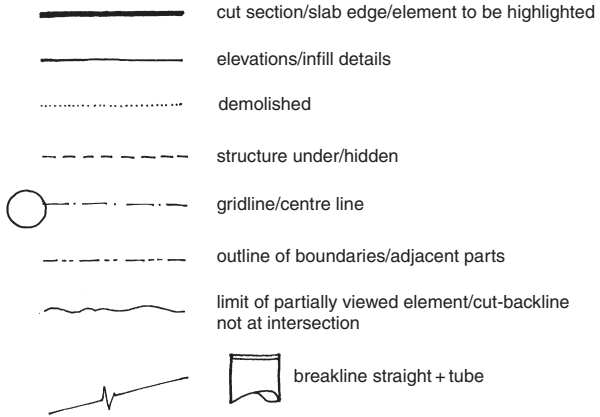

Hatching

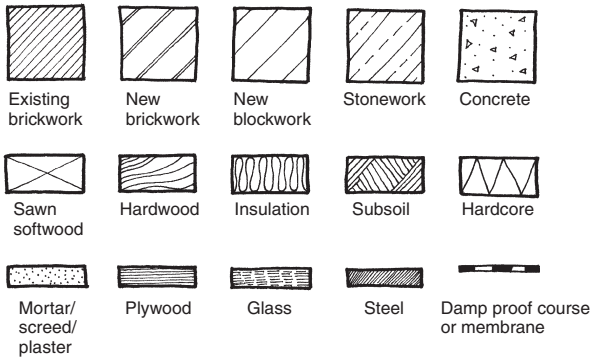

Steps, ramps and slopes

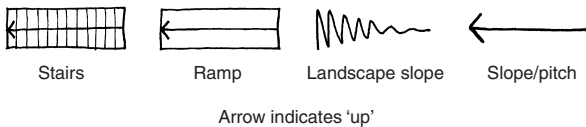

Common arrangement of work sections

The Common Arrangement of Work Sections for Building Work (CAWS) is intended to provide a standard for the production of specifications and bills of quantities for building projects, so that the work can be divided up more easily for costing and for distribution to subcontractors. The full document is very extensive, with sections to cover all aspects of the building work including: the contract, structure, fittings, finishes, landscaping and mechanical and electrical services. The following sections are extracts from CAWS to summarize the sections most commonly used by structural engineers:

A Preliminaries/ general conditions	A1	The project generally	A2	The contract
	A3	Employer's requirements	A4	Contractor's general costs
C Existing site/ buildings/ services	C1	Demolition	C2	Alteration – composite items
	C3	Alteration – support	C4	Repairing/renovating concrete/masonry
	C5	Repairing/renovating metal/timber		
D Groundwork	D1	Investigation/ stabilization/ dewatering	D2	Excavation/filling
	D3	Piling	D4	Diaphragm walling
	D5	Underpinning		
E In situ concrete/large precast concrete	E1	In situ concrete	E2	Formwork
	E3	Reinforcement	E4	In situ concrete sundries
	E5	Precast concrete large units	E6	Composite construction
F Masonry	F1	Brick/block walling	F2	Stone walling
	F3	Masonry accessories		
G Structural/ carcassing in metal or timber	G1	Structural/carcassing metal	G2	Structural/carcassing timber
	G3	Metal/timber decking		
R Disposal systems	R1	Drainage	R2	Sewerage

There is a very long list of further subheadings which can be used to cover sections in more detail (e.g. F10 is specifically for Brick/block walling). However, the list is too extensive to be included here.

Source: CPIC (1998).

Summary of ACE conditions of engagement

The Association of Consulting Engineers (ACE) represents the consulting sector of the engineering profession in the UK. The ACE Conditions of Engagement, Agreement B(1), 3rd Edition (2002) is used where the engineer is appointed directly to the client and works with an architect who is the lead consultant or contract administrator. A summary of the Normal Services from Agreement B(1) is given below with references to the lettered work stages (A–L) defined by the Royal Institute of British Architects (RIBA).

Feasibility		
Work Stage A	Appraisal	Identification of client requirements and development constraints by the Lead Consultant, with an initial appraisal to allow the client to decide whether to proceed and to select the probable procurement method.
Stage B	Strategic briefing	Confirmation of key requirements and constraints for or by the client, including any topographical, historical or contamination constraints on the proposals. Consider the effect of public utilities and transport links for construction and post construction periods on the project. Prepare a site investigation desk study and if necessary bring the full site investigation forward from Stage C. Identify the Project Brief, establish design team working relationships and lines of communication and discuss with the client any requirements for site staff or resident engineer. Collaborate on the design with the design team and prepare a stage report if requested by the client or lead consultant.
Pre-construction phase		
Stage C	Outline proposals	Visit the site and study any reports available regarding the site. Advise the client on the need and extent of site investigations, arrange quotes and proceed when quotes are approved by the client. Advise the client of any topographical or dimensional surveys that are required. Consult with any local or other authorities about matters of principle and consider alternative outline solutions for the proposed scheme. Provide advice, sketches, reports or outline specifications to enable the Lead Consultant to prepare his outline proposals and assist the preparation of a Cost Plan. Prepare a report and, if required, present to the client.
Stage D	Detailed proposals	Develop the design of the detailed proposals with the design team for submission of the Planning Application by the Lead Consultant. Prepare drawings, specifications, calculations and descriptions in order to assist the preparation of a Cost Plan. Prepare a report and, if required, present to the client.

Summary of ACE conditions of engagement – continued

Pre-construction phase – continued		
Stage E	Final proposals	Develop and co-ordinate all elements of the project in the overall scheme with the design team, and prepare calculations, drawings, schedules and specifications as required for presentation to the client. Agree a programme for the design and construction of the Works with the client and the design team.
Stage F	Production information	Develop the design with the design team and prepare drawings, calculations, schedules and specifications for the Tender Documentation and for Building Regulations Approval. Prepare any further drawings and schedules necessary to enable Contractors to carry out the Works, excluding drawings and designs for temporary works, formwork, and shop fabrication details (reinforcement details are not always included as part of the normal services). Produce a Designer's Risk Assessment in line with Health & Safety CDM Regulations. Advise the Lead Consultant on any special tender or contract conditions.
Stage G	Tender documents	Assist the Lead Consultant in identifying and evaluating potential contractors and/or specialists for the construction of the project. Assist the selection of contractors for the tender lists, assemble Tender Documentation and issue it to the selected tenderers. On return of tenders, advise on the relative merits of the contractors proposals, programmes and tenders.
Stage H	Tender action	
Construction phase		
Stage J	Mobilization	Assist the Client and Lead Consultant in letting the building contract, appointing the contractor and arranging site hand over to the contractor. Issue construction information to the contractor and provide further information to the contractor as and when reasonably required. Comment on detailed designs, fabrication drawings, bar bending schedules and specifications submitted by the Contractors, for general dimensions, structural adequacy and conformity with the design. Advise on the need for inspections or tests arising during the construction phase and the appointment and duties of Site Staff. Assist the Lead Consultant in examining proposals, but not including alternative designs for the Works, submitted by the Contractor. Attend relevant site meetings and make other periodic visits to the site as appropriate to the stage of construction. Advise the Lead Consultant on certificates for payment to Contractors. Check that work is being executed generally to the control documents and with good engineering practice. Inspect the construction on completion and, in conjunction with any Site Staff, record any defects. On completion, deliver one copy of each of the final structural drawings to the planning supervisor or client. Perform work or advise the Client in connection with any claim in connection with the structural works.
Stage K	Construction to practical completion	
Stage L	After practical completion	Assist the Lead Consultant with any administration of the building contract after practical completion. Make any final inspections in order to help the Lead Consultant settle the final account.

Source: ACE (1998).

2

Statutory Authorities and Permissions

Planning

Planning regulations control individuals' freedom to alter their property in an attempt to protect the environment in UK towns, cities and countryside, in the public interest. Different regulations and systems of control apply in the different UK regions. Planning permission is not always required, and in such cases the planning department will issue a Lawful Development Certificate on request and for a fee.

England and Wales

The main legislation which sets out the planning framework in England and Wales is the Town and Country Planning Act 1990. The government's statements of planning policy may be found in White Papers, Planning Policy Guidance Notes (PPGs), Mineral Policy Guidance Notes (MPGs), Regional Policy Guidance Notes (RPGs), departmental circulars and ministerial statements published by the Office of the Deputy Prime Minister (ODPM).

Scotland

The First Minister for Scotland is responsible for the planning framework. The main planning legislation in Scotland is the Town and Country Planning Act (Scotland) 1997 and the Planning (Listed Buildings and Conservation Areas) (Scotland) Act 1997. The legislation is supplemented by the Scottish Executive who publish National Planning Policy Guidelines (NPPGs) which set out the Scottish policy on land use and other issues. In addition, a series of Planning Advice Notes (PANs) give guidance on how best to deal with matters such as local planning, rural housing design and improving small towns and town centres.

Northern Ireland

The Planning (NI) Order 1991 could be said to be the most significant of the many different Acts which make up the primary and subordinate planning legislation in Northern Ireland. As in the other UK regions, the Northern Ireland Executive publishes policy guidelines called Planning Policy Statements (PPSs) which set out the regional policies to be implemented by the local authority.

Building regulations and standards

Building regulations have been around since Roman times and are now used to ensure reasonable standards of construction, health and safety, energy efficiency and access for the disabled. Building control requirements, and their systems of control, are different for the different UK regions.

The legislation is typically set out under a Statutory Instrument, empowered by an Act of Parliament. In addition, the legislation is further explained by the different regions in explanatory booklets, which also describe the minimum standards 'deemed to satisfy' the regulations. The 'deemed to satisfy' solutions do not preclude designers from producing alternative solutions provided that they can be supported by calculations and details to satisfy the local authority who implement the regulations. Building control fees vary around the country but are generally calculated on a scale in relation to the cost of the work.

England and Wales

England and Wales has had building regulations since about 1189 when the first version of a London Building Act was issued. Today the relevant legislation is the Building Act 1984 and the Statutory Instrument Building Regulations 2000. The Approved Documents published by the ODPM are the guide to the minimum requirements of the regulations.

Applications may be made as 'full plans' submissions well before work starts, or for small elements of work as a 'building notice' 48 hours before work starts. Completion certificates demonstrating Building Regulations Approval can be obtained on request. Third parties can become approved inspectors and provide building control services.

Approved documents (as amended)

- A** Structure
 - A1 Loading
 - A2 Ground Movement
 - A3 and A4 Disproportionate Collapse
- B** Fire Safety
- C** Site Preparation and Resistance to Moisture
- D** Toxic Substances
- E** Resistance to the Passage of Sound
- F** Ventilation
- G** Hygiene
- H** Drainage and Waste Disposal
- J** Heat Producing Appliances
- K** Stairs, Ramps and Guards
- L** Conservation of Fuel and Power
- M** Access and Facilities for Disabled People
- N** Glazing – Materials and Protection
- Regulation 7** Materials and Workmanship

Scotland

Building standards have been in existence in Scotland since around 1119 with the establishment of the system of Royal Burghs. The three principal documents which currently govern building control are the Building (Scotland) Act 1959 (as amended), the Building Standards (Scotland) Regulations 1990 (as amended) and the Technical Standards 1990 – the explanatory guide to the regulations published by the Scottish Executive.

Applications for all building and demolition work must be made to the local authority, who assess the proposals for compliance with the technical standards, before issuing a building warrant, which is valid for five years. Unlike the other regions in the UK, work may only start on site once a warrant has been obtained. Buildings may only be occupied at the end of the construction period once the local authority have issued a completion certificate. Building control departments typically will only assess very simple structural proposals and for more complicated work, qualified engineers must 'self-certify' their proposals.

Technical standards

- A** General and Definitions
- B** Fitness of Materials
- C** Structure
- D** Structural Fire Precautions
- E** Means of Escape from Fire
- F** Heat Producing Installations and Storage of Liquid and Gaseous Fuels
- G** Preparation of Sites and Resistance to Moisture
- H** Resistance to Transmission of Sound
- J** Conservation of Fuel and Power
- K** Ventilation of Buildings
- M** Drainage and Sanitary Facilities
- N** Electrical Installations
- P** Miscellaneous Hazards
- Q** Facilities for Dwellings
- R** Solid Waste Storage, Dungsteads and Farm Effluent Tanks
- S** Stairs, Ramps and Protective Barriers

Northern Ireland

The main legislation, policy and guidelines in Northern Ireland are the Building Regulations (Northern Ireland) Order 1979 as amended by the Planning and Building Regulations (Northern Ireland) (Amendment) Order 1990; the Building Regulations (NI) 2000 and the technical booklets – which describe the minimum requirements of the regulations published by the Northern Ireland Executive.

Building regulations in Northern Ireland are the responsibility of the Department of Finance and Personnel and are implemented by the district councils. Until recently the regulations operated on strict prescriptive laws, but the system is now very similar to the system in England and Wales. Applicants must demonstrate compliance with the 'deemed to satisfy' requirements. Applications may be made as a 'full plans' submission well before work starts, or as a 'building notice' for domestic houses just before work starts. Builders must issue stage notices for local authority site inspections. Copies of the stage notices should be kept with the certificate of completion by the building owner.

Technical booklets

- A** Interpretation and General
- B** Materials and Workmanship
- C** Preparation of Sites and Resistance to Moisture
- D** Structure
- E** Fire Safety
- F** Conservation of Fuel and Power
- G** Sound Insulation
- H** Stairs, Ramps and Guarding
- J** Solid Waste in Buildings
- K** Ventilation
- L** Heat Producing Appliances and LPG Systems
- N** Drainage
- P** Sanitary Appliances and Unvented Hot Water Storage Systems
- R** Access and Facilities for Disabled People
- V** Glazing

Listed buildings

In the UK, buildings of 'special architectural or historic interest' can be listed to ensure that their features are considered before any alterations are agreed to the exterior or interior. Buildings may be listed because of their association with an important architect, person or event or because they are a good example of design, building type, construction or use of material. Listed building consent must be obtained from the local authority before any work is carried out on a listed building. In addition, there may be special conditions attached to ecclesiastical, or old ecclesiastical, buildings or land by the local diocese or the Home Office.

England and Wales

English Heritage (EH) in England and CADW in Wales work for the government to identify buildings of 'special architectural or historic interest'. All buildings built before 1700 (and most buildings between 1700 and 1840) with a significant number of original features will be listed. A building normally must be over 30 years old to be eligible for listing. There are three grades: I, II* and II, and there are approximately 500 000 buildings listed in England, with about 13 000 in Wales. Grades I and II* are eligible for grants from EH for urgent major repairs and residential listed buildings may be VAT zero rated for approved alterations.

Scotland

Historic Scotland maintains the lists and schedules for the Scottish Executive. All buildings before 1840 of substantially unimpaired character can be listed. There are over 40 000 listed buildings divided into three grades: A, B and C. Grade A is used for buildings of national or international importance or little altered examples of a particular period, style or building type, while a Grade C building would be of local importance or be a significantly altered example of a particular period, style or building type.

Northern Ireland

The Environment and Heritage Service (EHS) within the Northern Ireland Executive has carried out a survey of all the building stock in the region and keeps the Northern Ireland Buildings Database. Buildings must be at least 30 years old to be listed and there are currently about 8500 listed buildings. There are three grades of listing: A, B+ and B (with two further classifications B1 and B2) which have similar qualifications to the other UK regions.

Conservation areas

Local authorities have a duty to designate conservation areas in any area of 'special architectural or historic interest' where the character or appearance of the area is worth preserving or enhancing. There are around 8500 conservation areas in England and Wales, 600 in Scotland and 30 in Northern Ireland. The character of an area does not just come from buildings and so the road and path layouts, greens and trees, paving and building materials and public and private spaces are protected. Conservation area consent is required from the local authority before work starts to ensure any alterations do not detract from the area's appearance.

Tree preservation orders

Local authorities have specific powers to protect trees by making Tree Protection Orders (TPOs). Special provisions also apply to trees in conservation areas. A TPO makes it an offence to cut down, lop, top, uproot, wilfully damage or destroy the protected tree without the local planning authority's permission. All of the UK regions operate similar guidelines with slightly different notice periods and penalties.

The owner remains responsible for the tree(s), their condition and any damage they may cause, but only the planning authority can give permission to work on them. Arboriculturalists (who can give advice on work which needs to be carried out on trees) and contractors (who are qualified to work on trees) should be registered with the Arboricultural Association. In some cases (including if the tree is dangerous) no permission is required, but notice (about 5 days (or 6 weeks in a conservation area) depending on the UK region) must be given to the planning authority. When it is agreed that a tree can be removed, this is normally on the condition that a similar tree is planted as a replacement. Permission is generally not required to cut down or work on trees with a trunk less than 75 mm diameter (measured at 1.5 m above ground level) or 100 mm diameter if thinning to help the growth of other trees. Fines of up to £20 000 can be levied if work is carried out without permission.

Archaeology and ancient monuments

Archaeology in Scotland, England and Wales is protected by the Ancient Monuments and Archaeology Areas Act 1979, while the Historic Monuments and Archaeology Objects (NI) Order 1995 applies in Northern Ireland.

Archaeology in the UK can represent every period from the camps of hunter gatherers 10000 years ago to the remains of twentieth century industrial and military activities. Sites include places of worship, settlements, defences, burial grounds, farms, fields and sites of industry. Archaeology in rural areas tends to be very close to the ground surface, but in urban areas, deep layers of deposits were built up as buildings were demolished and new buildings were put directly on the debris. These deposits, often called 'medieval fill', are an average of 5 m deep in places like the City of London and York.

Historic or ancient monuments are structures which are of national importance. Typically monuments are in private ownership but are not occupied buildings. Scheduled monument consent is required for alterations and investigations from the regional heritage bodies: English Heritage, Historic Scotland, CADW in Wales and EHS in Northern Ireland.

Each of the UK regions operates very similar guidelines in relation to archaeology, but through different frameworks and legislation. The regional heritage bodies develop the policies which are implemented by the local authorities. These policies are set out in PPG 16 for England and Wales, NPPG 18 for Scotland and PPS 6 for Northern Ireland. These guidance notes are intended to ensure that:

1. Archaeology is a material consideration for a developer seeking planning permission.
2. Archaeology strategy is included in the urban development plan by the local planning authority.
3. Archaeology is preserved, where possible, in situ.
4. The developer pays for the archaeological investigations, excavations and reporting.
5. The process of assessment, evaluation and mitigation is a requirement of planning permission.
6. The roles of the different types of archaeologists in the processes of assessment, evaluation and mitigation are clearly defined.

Where 'areas of archaeological interest' have been identified by the local authorities, the regional heritage bodies act as curators (English Heritage, Historic Scotland, CADW in Wales and EHS in Northern Ireland). Any developments within an area of archaeological interest will have archaeological conditions attached to the planning permission to ensure that the following process is put into action:

1. Early consultation between the developers and curators so that the impact of the development on the archaeology (or vice versa) can be discussed and the developer can get an idea of the restrictions which might be applied to the site, the construction process and the development itself.
2. Desk study of the site by an archaeologist.
3. Field evaluation by archaeologists using field walking, trial pits, boreholes and/or geophysical prospecting to support the desk study.
4. Negotiation between the site curators and the developer's design team to agree the extent of archaeological mitigation. The developer must submit plans for approval by the curators.
5. Mitigation – either preservation of archaeology in situ or excavation of areas to be disturbed by development. The archaeologists may have either a watching brief over the excavations carried out by the developer (where they monitor construction work for finds) or on significant sites, carry out their own excavations.
6. Post-excavation work to catalogue and report on the archaeology, either store or display the findings.

Generally the preliminary and field studies are carried out by private consultants and contractors employed by the developers to advise the local authority planning department. In some areas advice can also be obtained from a regional archaeologist. In Northern Ireland, special licences are required for every excavation which must be undertaken by a qualified archaeologist. In Scotland, England and Wales, the archaeological contractors or consultants have a 'watching brief'.

Field evaluations can often be carried out using geotechnical trial pits with the excavations being done by the contractor or the archaeologist depending on the importance of the site. If an interesting find is made in a geotechnical trial pit and the archaeologists would like to keep the pit open for inspection by, say, the curators, the developer does not have to comply if there would be inconvenience to the developer or building users, or for health and safety reasons.

Engineers should ensure for the field excavation and mitigation stages that the archaeologists record **all** the features in the excavations up to this century's interventions as these records can be very useful to the design team. Positions of old concrete footings could have as much of an impact on proposed foundation positions as archaeological features!

Party Wall etc. Act

The Party Wall etc. Act 1996 came into force in 1997 throughout England and Wales. In 2002 there is no equivalent legislation in Northern Ireland and in Scotland, the Law of the Tenement is only in draft form.

Different sections of the Party Wall Act apply, depending on whether you propose to carry out work to an existing wall or structure shared with another property; build a free-standing wall or the wall of a building astride a boundary with a neighbouring property, and/or excavate within 3 m of a neighbouring building or structure. Work can fall within several sections of the Act at one time. A building Owner must notify his neighbours and agree the terms of a Party Wall Award before starting any work.

The Act refers to two different types of Party Structure: 'Party Wall' and 'Party Fence Wall'. Party Walls are loosely defined as a wall on, astride or adjacent to a boundary enclosed by building on one or both sides. Party Fence Walls are walls astride a boundary but not part of a building; it does not include things like timber fences. A Party Structure is a wide term which can sometimes include floors or partitions.

The Notice periods and sections 1, 2 and 6 of the Act are most commonly used, and are described below.

Notice periods and conditions

In order to exercise rights over the Party Structures, the Act says that the Owner must give Notice to Adjoining Owners; the building Owner must not cause unnecessary inconvenience, must provide compensation for any damage and must provide temporary protection for buildings and property where necessary. The Owner and the Adjoining Owner in the Act are defined as anyone with an interest greater than a tenancy from year to year. Therefore this can include shorthold tenants, long leaseholders and freeholders for any one property.

A building Owner, or surveyor acting on his behalf, must send a Notice in advance of the start of the work. Different Notice periods apply to different sections of the Act, but work can start within the Notice period with the written agreement of the Adjoining Owner. A Notice is only valid for one year from the date that it is served and must include the Owner's name and address, the building's address (if different); a clear statement that the Notice is under the provisions of the Act (stating the relevant sections); full details of the proposed work (including plans where appropriate) and the proposed start date for the work.

The Notice can be served by post, in person or fixed to the adjoining property in a 'conspicuous part of the premises'. Once the Notice has been served, the Adjoining Owner can consent in writing to the work or issue a counter Notice setting out any additional work he would like to carry out. The Owner must respond to a counter Notice within 14 days. If the Owner has approached the Adjoining Owners and discussed the work with them, the terms of a Party Wall Award may have already been agreed in writing before a Notice is served.

If a Notice is served and the Adjoining Owner does not respond within 14 days, a dispute is said to have arisen. If the Adjoining Owner refuses to discuss terms or appoint a surveyor to act on his behalf, the Owner can appoint a surveyor to act on behalf of the Adjoining Owner. If the Owners discuss, but cannot agree terms they can jointly appoint a surveyor (or they can each appoint one) to draw up the Party Wall Award. If two surveyors cannot agree, a nominated Third Surveyor can be called to act impartially. In complex cases, this can often take over a year to resolve and in such cases the Notice period can run out, meaning that the process must begin again by serving another Notice. In all cases, the surveyors are appointed to consider the rights of the Owner over the wall and not to act as advocates in the negotiation of compensation! The building Owner covers the costs associated with all of the surveyors and experts asked about the work.

When the terms have been agreed, the Party Wall Award should include a description (in drawings and/or writing) of what, when and how work is to be carried out; a record of the condition of the adjoining Owner's property before work starts; arrangements to allow access for surveyors to inspect while the works are going on and say who will pay for the cost of the works (if repairs are to be carried out as a shared cost or if the adjoining Owner has served a counter Notice and is to pay for those works). Either Owner has 14 days to appeal to the County Court against an Award if an Owner believes that the person who has drafted the Award has acted beyond their powers.

An Adjoining Owner can ask the owner for a 'bond'. The bond money becomes the property of the Adjoining Owner (until the work has been completed in accordance with the Award) to ensure that funds are available to pay for the completion of the works in case the Owner does not complete the works.

The Owner must give 14 days' Notice if his representatives are to access the Adjoining Owner's property to carry out or inspect the works. It is an offence to refuse entry or obstruct someone who is entitled to enter the premises under the Act if the offender knows that the person is entitled to be there. If the adjoining property is empty, the Owner's workmen and own surveyor or architect may enter the premises if they are accompanied by a police officer.

Section 1 – new building on a boundary line

Notice must be served to build on or astride a boundary line, but there is no right to build astride if your neighbour objects. You can build foundations on the neighbouring land if the wall line is immediately adjacent to the boundary, subject to supervision. The Notice is required at least **1 month** before the proposed start date.

Section 2 – work on existing party walls

The most commonly used rights over existing Party Walls include cutting into the wall to insert a DPC or support a new beam bearing; raising, underpinning, demolishing and/or rebuilding the Party Wall and/or providing protection by putting a flashing from the higher over the lower wall. Minor works such as fixing shelving, fitting electrical sockets or replastering are considered to be too trivial to be covered in the Act.

A building Owner, or Party Wall Surveyor acting on the Owner's behalf must send a Notice at least **2 months** in advance of the start of the work.

Section 6 – excavation near neighbouring buildings

Notice must be served at least **1 month** before an Owner intends to excavate or construct a foundation for a new building or structure within 3 m of an adjoining Owner's building where that work will go deeper than the adjacent Owner's foundations, or within 6 m of an adjoining Owner's building where that work will cut a line projecting out at 45° from the bottom of that building's foundations. This can affect neighbours who are not immediately adjacent. The Notice must state whether the Owner plans to strengthen or safeguard the foundations of the Adjoining Owner. Adjoining Owners must agree specifically in writing to the use of 'special foundations' – these include reinforced concrete foundations. After work has been completed, the Adjoining Owner may request particulars of the work, including plans and sections.

Source: DETR (1997).

CDM

The Construction Design & Management (CDM) Regulations 1994 were developed to assign responsibilities for health and safety to the client, design team and principal contractor. The Approved Code of Practice is published by the Health and Safety Executive for guidance to the Regulations.

The client is required to appoint a planning supervisor (PS) who has overall responsibility for co-ordinating health and safety aspects of the design and planning stages of a project. The duties of the PS can theoretically be carried out by any of the traditional design team professionals. The PS must ensure that the designers avoid, minimize or control health and safety risks for the construction and maintenance of the project, as well as ensuring that the contractor is competent to carry out the work.

The PS prepares the pre-contract health and safety plan for inclusion in the tender documents which should include project-relevant health and safety information gathered from the client and designers. This should highlight any unusual aspects of the project (also highlighted on the drawings) that a competent contractor would not be expected to know. This document is taken on by the successful principal contractor and developed into the construction phase health and safety plan by the addition of the contractor's health and safety policy, risk assessments and method statements as requested by the designers. The health and safety plan is intended to provide a focus for the management and prevention of health and safety risks as the construction proceeds.

The health and safety file is generally compiled at the end of the project by the contractor and the PS who collect the design information relevant to the life of the building. The PS must ensure that the file is compiled and passed to the client or the people who will use, operate, maintain and/or demolish the project. A good health and safety file will be a relatively compact maintenance manual including information to alert those who will be owners, or operators of the new structure, to the risks which must be managed when the structure and associated plant is maintained, repaired, renovated or demolished. After handover the client is responsible for keeping the file up to date.

3

Design Data

Design data checklist

The following design data checklist is a useful reminder of all of the limiting criteria which should be considered when selecting an appropriate structural form:

- Description/building use
- Client brief and requirements
- Site constraints
- Loadings
- Structural form: load transfer, stability and robustness
- Materials
- Movement joints
- Durability
- Fire resistance
- Performance criteria: deflection, vibration, etc.
- Temporary works and construction issues
- Soil conditions, foundations and ground slab
- Miscellaneous issues

Structural form, stability and robustness

Structural form

It is worth trying to remember the different structural forms when developing a scheme design. A particular structural form might fit the vision for the form of the building. Force or moment diagrams might suggest a building shape. The following diagrams of structural form are intended as useful reminders:

TRUSSES



Couple

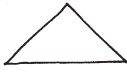

Tied rafter

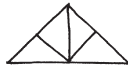

King post

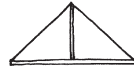

Queen post

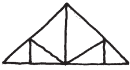

Howe
(\neq 10 m steel/
timber)

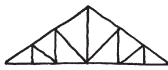

Double howe
(8–15 m steel/
timber)



Fink
(\neq 10 m steel/
timber)



Double fink
(5–14 m timber)
(8–13 m steel)



Bowshing

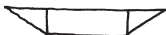

Thrust



Scissor
(6–10 m steel/
timber)



Double scissor
(10–13 m steel/
timber)



Northlight
(\neq 5 m steel)



Northlight
(5–15 m steel)



Fan
(8–15 m steel)



French truss
(12–20 m steel)



Bowshing
(20–40 m steel)



Umbrella
(~13 m steel)



Saw tooth
(~5 m steel)

GIRDERS



Pratt



Warren



Modified warren



Howe



Fink

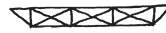

Modified fink



Double lattice

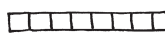

Vierendeel

PORTAL FRAMES

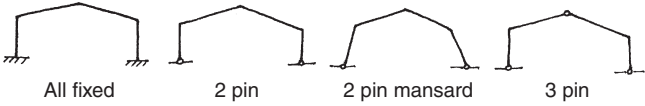

ARCHES

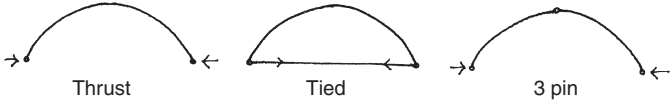

SUSPENSION



WALLS



TIMBER

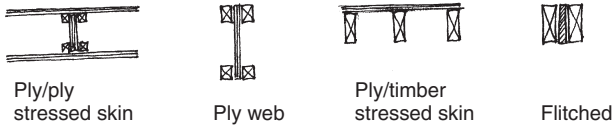

RETAINING WALLS

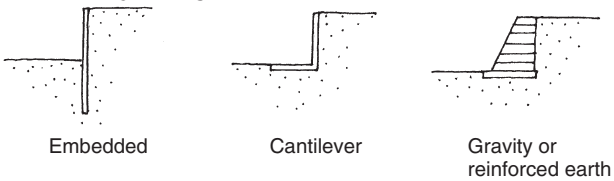

Stability

Stability of a structure must be achieved in two orthogonal directions. Circular structures should also be checked for rotational failure. The positions of movement and/or acoustic joints should be considered and each part of the structure should be designed to be independently stable and robust. Lateral loads can be transferred across the structure and/or down to the foundations by using any of the following methods:

- Cross bracing which carries the lateral forces as axial load in diagonal members.
- Diaphragm action of floors or walls which carry the forces by panel/plate/shear action.
- Frame action with 'fixed' connections between members and 'pinned' connections at the supports.
- Vertical cantilever columns with 'fixed' connections at the foundations.
- Buttressing with diaphragm, chevron or fin walls.

Stability members must be located on the plan so that their shear centre is aligned with the resultant of the overturning forces. If an eccentricity cannot be avoided, the stability members should be designed to resist the resulting torsion across the plan.

Robustness and disproportionate collapse

All structural elements should be effectively tied together in each of the two orthogonal directions, both horizontally and vertically. This is generally achieved by specifying connections in steel buildings as being of certain minimum size, by ensuring that reinforced concrete junctions contain a minimum area of steel bars and by using steel straps to connect walls and floors in masonry structures. It is important to consider robustness requirements early in the design process.

The Building Regulations require buildings of five or more storeys (excluding the roof) to be designed for disproportionate collapse. This is intended to ensure that accidental damage to elements of the building structure cannot cause the collapse of a disproportionately large area of a building. The disproportionate collapse requirement for public buildings with a roof span of more than 9m appears to have been removed from the regulations.

Typically the Building Regulations require that any collapse caused by the failure of a single structural element should be limited to an area of 70 m² or 15% of any storey area (whichever is the lesser). Alternatively the designer can strengthen the structure to withstand the 'failure' of certain structural supports in order to prevent disproportionate collapse. In some circumstances the structure cannot be arranged to avoid the occurrence of 'key elements', which support disproportionately large areas of the building. These 'key elements' must be designed as protected members (to the code of practice for the relevant structural material) to provide extra robustness and damage resistance.

Structural movement joints

Joints should be provided to control temperature, moisture, acoustic and ground movements. Movement joints can be difficult to waterproof and detail and therefore should be kept to a minimum. The positions of movement joints should be considered for their effect on the overall stability of the structure.

Primary movement joints

Primary movement joints are required to prevent cracking where buildings (or parts of buildings) are large, where a building spans different ground conditions, changes height considerably or where the shape suggests a point of natural weakness. Without detailed calculation, joints should be detailed to permit 15–25 mm movement. Advice on joint spacing for different building types can be variable and conflicting. The following figures are some approximate guidelines based on the building type:

Concrete	25 m (e.g. for roofs with large thermal differentials)–50 m c/c.
Steel industrial buildings	100 m typical–150 m maximum c/c.
Steel commercial buildings	50 m typical–100 m maximum c/c.
Masonry	40 m–50 m c/c.

Secondary movement joints

Secondary movement joints are used to divide structural elements into smaller elements to deal with the local effects of temperature and moisture content. Typical joint spacings are:

Clay bricks	Up to 12 m c/c on plan (6 m from corners) and 9 m vertically or every three storeys if the building is greater than 12 m or four storeys tall.
Concrete blocks	3 m–7 m c/c.
Hardstanding	70 m c/c.
Steel roof sheeting	20 m c/c down the slope, no limit along the slope.

Fire resistance periods for structural elements

Fire resistance of structure is required to maintain structural integrity to allow time for the building to be evacuated. Generally, roofs do not require protection. Architects typically specify fire protection in consultation with the engineer.

Building types		Minimum period of fire resistance minutes					
		Basement storey including floor over		Ground or upper storey			
		Depth of a lowest basement		Height of top floor above ground, in a building or separated part of a building			
		> 10 m	< 10 m	> 5 m	< 18 m	< 30 m	< 120 m
Residential flats and maisonettes		90	60	30 ¹	60 ²	90 ²	120 ²
Residential houses		n/a	30 ¹	30 ¹	60 ³	n/a	n/a
Institutional residential ⁴		90	60	30 ¹	60	90	120 ⁵
Office	not sprinklered	90	60	30 ¹	60	90	X
	sprinklered	60	60	30 ¹	30 ¹	60	120 ⁵
Shops & commercial	not sprinklered	90	60	60	60	90	X
	sprinklered	60	60	30 ¹	60	60	120 ⁵
Assembly & recreation	not sprinklered	90	60	60	60	90	X
	sprinklered	60	60	30 ¹	60	60	120 ⁵
Industrial	not sprinklered	120	90	60	90	120	X
	sprinklered	90	60	30 ¹	60	90	120 ⁵
Storage and other non-residential	not sprinklered	120	90	60	90	120	X
	sprinklered	90	60	30 ¹	60	90	120 ⁵
Car park for light vehicles	open sided	n/a	n/a	15 ¹	15 ¹	15 ¹	60
	all others	90	60	30 ¹	60	90	120 ⁵

NOTES:

X Not permitted

1. Increased to 60 minutes for compartment walls with other fire compartments or 30 minutes for elements protecting a means of escape.
2. Reduced to 30 minutes for a floor in a maisonette not contributing to the support of the building.
3. To be 30 minutes in the case of three storey houses and 60 minutes for compartment walls separating buildings.
4. NHS hospitals should have a minimum of 60 minutes.
5. Reduced to 90 minutes for non-structural elements.
6. Should comply with Building Regulations: B3 section 12.

Source: Building Regulations Approved Document B (1991).

Typical building tolerances

SPACE BETWEEN WALLS

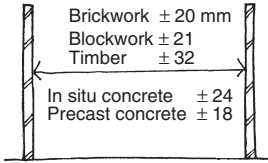

SPACE BETWEEN COLUMNS

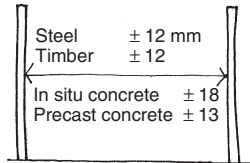

WALL VERTICALITY

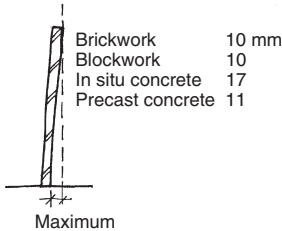

COLUMN VERTICALITY

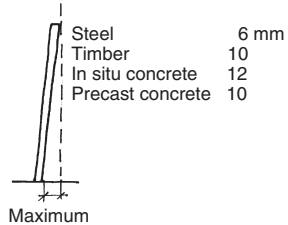

VERTICAL POSITION OF BEAMS

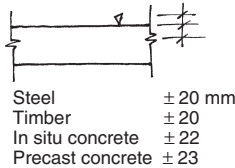

VERTICAL POSITION OF FLOORS

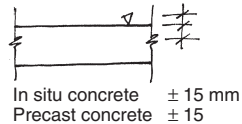

PLAN POSITION

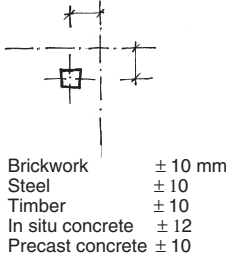

FLATNESS OF FLOORS

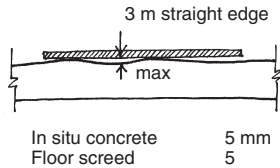

Historical use of building materials

Masonry and timber

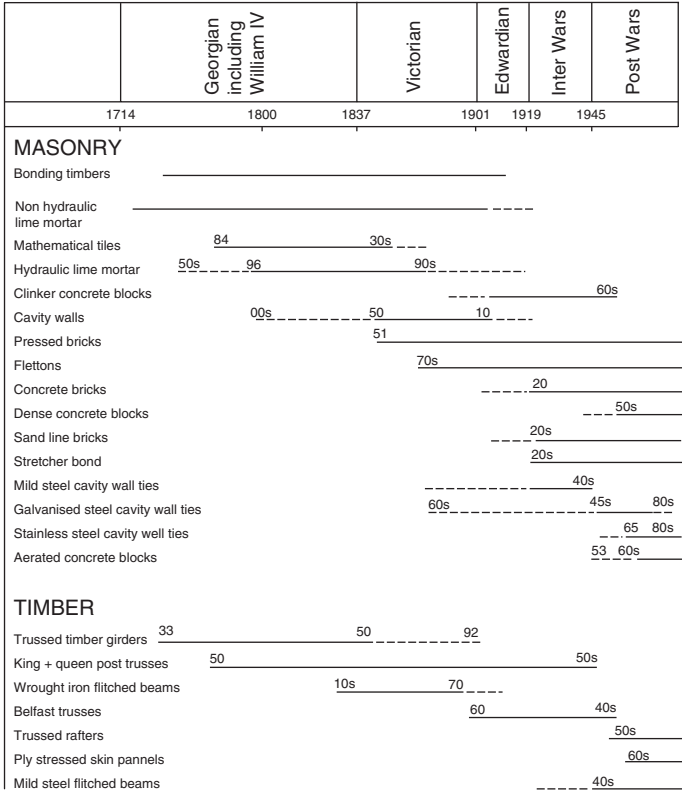

Source: Richardson, C. (2000).

Concrete and steel

	Georgian including William IV	Victorian	Edwardian	Inter-Wars	Post-Wars	
	1714	1800	1837	1901	1919	1945
CONCRETE						
Limecrete/Roman cement		96		80s		
Jack arch floors		96		62		
Portland cement			24	51		30
Filler joists				70s	30s	
Clinker concrete				80	30	
RC framed buildings			54		97	
RC shells + arches						20s
Hollow pot slabs					25	80
Flat slabs				00s	31	
Lightweight concrete					32	50
Precast concrete floors						50
Composite metal deck slabs						52 64
Woodwool permanent shutters						69 90s
Waffle/coffered slabs						60s
Composite steel + concrete floors with shear keys						70s
CAST IRON (CI) + WROUGHT IRON (WI)						
CI columns		20s	92			30s
CI beams			96		65	
WI rods + flats				10s	80	
WI roof trusses			37			
WI built up beams			40			
WI rolled sections			50s			
'Cast steel' columns				90s	10s	
MILD STEEL						
Plates + rods					80	
Riveted sections				90s	60	
Hot rolled sections					83	
Roof trusses				90s		
Steel framed buildings				96		
Welds						55
Castellated beams					38	
High strength friction grip bolts (HSFG)						50
Hollow sections						60
					13	70s
STAINLESS STEEL						
Bolts, straps, lintels, shelf angles, etc.						

Source: Richardson, C. (2000).

Typical weights of building materials

Material	Description	Thickness/ quantity of unit	Unit load kN/m ²	Bulk density kN/m ³
Aggregate				16
Aluminium	Cast alloy			27
	Longstrip roofing	0.8 mm	0.022	
Aluminium bronze				76
Asphalt	Roofing – 2 layers	25 mm	0.58	
	Paving			21
Ballast	see Gravel			
Balsa wood				1
Bituminous felt roofing	3 layers and vapour barrier		0.11	
Bitumen				11–13
Blockboard	Sheet	18 mm	0.11	
Blockwork	Lightweight – dense			10–20
Books	On shelves			7
	Bulk			8–11
Brass	Cast			85
Brickwork	Blue			24
	Engineering			22
	Fletton			18
	London stock			19
	Sand lime			21
Bronze	Cast			83
Cast stone				23
Cement				15
Concrete	Aerated			10
	Lightweight aggregate			18
	Normal reinforced			24
Coal	Loose lump			9
Chalk				22
Chipboard				7
Chippings	Flat roof finish	1 layer	0.05	
Clay	Undisturbed			19
Copper	Cast			87
	Longstrip roofing	0.6 mm	0.05	

Cork	Granulated			1
Double decker bus	see Vehicles			
Elephants	Adult group		3.2	
Felt	Roofing underlay		0.015	6
	Insulating	50 mm	0.05	
Glass	Crushed/refuse			16
	Clear float			25
Glass wool	Quilt	100 mm	0.01	
Gold				194
Gravel	Loose			16
	Undisturbed			21
Hardboard				6-8
Hardcore				19
Hardwood	Greenheart			10
	Oak			8
	Iroko, teak			7
	Mahogany			6
Hollow clay pot slabs	Including ribs and mortar but excluding topping	300 mm thick overall		12
		100 mm thick overall		15
Iron	Cast			72
	Wrought			77
Ivory				19
Lead	Cast			114
	Sheet	1.8 mm	0.21	
	Sheet	3.2 mm	0.36	
Lime	Hydrate (bags)			6
	Lump/quick (powder)			10
	Mortar (putty)			18
Linoleum	Sheet	3.2 mm	0.05	
Macadam	Paving			21
Magnesium	Alloys			18
MDF	Sheet			8
Mercury				136
Mortar				17-18
Mud				17-20
Partitions	Plastered brick	102 + 2 × 13 mm	2.6	21
	Medium dense plastered block	100 + 2 × 13 mm	2.0	16
	Plaster board on timber stud	100 + 2 × 13 mm	0.35	3

Typical weights of building materials – continued

Material	Description	Thickness/ quantity of unit	Unit load kN/m ²	Bulk density kN/m ³
Patent glazing	Single glazed		0.26–0.3	25
	Double glazed		0.52	
Pavement lights	Cast iron or concrete framed	100 mm	1.5	
Perspex	Corrugated sheets		0.05	12
Plaster	Lightweight	13 mm	0.11	9
	Wallboard and skim coat	13 mm	0.12	
	Lath and plaster	19 mm	0.25	
	Traditional lime plaster			20
Plywood	Sheet			7
Polystyrene	Expanded sheet			2
Potatoes				7
Precast concrete planks	Beam and block plus 50 mm topping	150–225 mm	1.8–3.3	
	Hollowcore plank	150 mm	2.4	
	Hollowcore plank	200 mm	2.7	
	Solid plank and 50 mm topping	75–300 mm	3.7–7.4	
Quarry tiles	Including mortar bedding	12.5 mm	0.32	
Roofing tiles	Clay – plain		0.77	19
	Clay pantile		0.42	19
	Concrete		0.51	24
	Slate		0.30	28
Sand	Dry, loose			16
	Wet, compact			19
Screed	Sand/cement			22
Shingle	Coarse, graded, dry			19
Slate	Slab			28
Snow	Fresh		minimum 0.6	1
	Wet, compacted		minimum 0.6	3
Softwood	Battens for slating and tiling		0.03	6
	25 mm tongued and grooved boards on 100 × 50 timber joists at 400 c/c		0.23	
	25 mm tongued and grooved boards on 250 × 50 timber joists at 400 c/c		0.33	
Soils	Loose sand and gravels			16
	Dense sand and gravels			22
	Soft/firm clays and silts			18
	Stiff clays and silts			21

Stainless steel roofing	Longstrip	0.4 mm	0.05	78
Steel	Mild			78
Stone				
Granite	Cornish (Cornwall)			26
	Rublislaw (Grampian)			25
Limestone	Bath (Wiltshire)			21
	Mansfield (Nottinghamshire)			22
	Portland (Dorset)			22
Marble	Italian			27
Sandstone	Bramley Fell (West Yorkshire)			22
	Forest of Dean (Gloucestershire)			24
	Darley Dale or Kerridge (Derbyshire)			23–25
Slate	Welsh			28
Terracotta				18
Terrazzo	Paving	20 mm	0.43	22
Thatch	Including battens	305 mm	0.45	
Timber	see Hardwood or Softwood			
Vehicles	London bus	73.6 kN		
	New Mini Cooper	11.4 kN		
	Rolls Royce	28.0 kN		
	Volvo estate	17.8 kN		
Water	Fresh			10
	Salt			10–12
Woodwool slabs				6
Zinc	Cast			72
	Longstrip roofing	0.8 mm	0.06	

Minimum imposed floor loads

The following table from BS 6399: Part 1 gives the normally accepted minimum floor loadings. Clients can consider sensible reductions in these loads if it will not compromise future flexibility. A survey by Arup found that office loadings very rarely even exceed the values quoted for domestic properties.

The gross live load on columns and/or foundations from sections A to D in the table, can be reduced in relation to the number of floors or floor area carried to BS 6399: Part 1. Live load reductions are not permitted for loads from storage and/or plant, or where exact live loadings have been calculated.

Type of activity/occupancy for part of the building or structure	Examples of specific use	UDL kN/m ²	Point load kN
A Domestic and residential activities (also see category C)	All usages within self-contained dwelling units. Communal areas (including kitchens) in blocks of flats with limited use (see Note 1) (for communal areas in other blocks of flats, see C3 and below)	1.5	1.4
	Bedrooms and dormitories except those in hotels and motels	1.5	1.8
	Bedrooms in hotels and motels Hospital wards Toilet areas	2.0	1.8
	Billiard rooms	2.0	2.7
	Communal kitchens except in flats covered by Note 1	3.0	4.5
	Balconies Single dwelling units and communal areas in blocks of flats with limited use (see Note 1)	1.5	1.4
	Guest houses, residential clubs and communal areas in blocks of flats except as covered by Note 1	Same as rooms to which they give access but with a minimum of 3.0	1.5/m run concentrated at the outer edge
Hotels and motels	Same as rooms to which they give access but with a minimum of 4.0	1.5/m run concentrated at the outer edge	
B Offices and work areas not covered elsewhere	Operating theatres, X-ray rooms, utility rooms	2.0	4.5
	Work rooms (light industrial) without storage	2.5	1.8
	Offices for general use	2.5	2.7
	Banking halls	3.0	2.7
	Kitchens, laundries, laboratories	3.0	4.5
	Rooms with mainframe computers or similar equipment	3.5	4.5
	Machinery halls, circulation spaces therein	4.0	4.5
	Projection rooms	5.0	Determine loads for specific use
	Factories, workshops and similar buildings (general industrial)	5.0	4.5
	Foundries	20.0	Determine loads for specific use
	Catwalks	–	1.0 at 1 m c/c
	Balconies	Same adjacent rooms but with a minimum of 4.0	1.5 kN/m run concentrated at the outer edge
	Fly galleries (load to be distributed uniformly over width)	4.5 kN/m run	–
Ladders	–	1.5 rung load	

C Areas where people may congregate	Public, institutional and communal dining rooms and lounges, cafes and restaurants (see Note 2)		2.0	2.7
	C1 Areas with tables			
	Reading rooms with no book storage		2.5	4.5
	Classrooms		3.0	2.7
C2 Areas with fixed seats	Assembly areas with fixed seating (see Note 3)		4.0	3.6
	Places of worship		3.0	2.7
C3 Areas without obstacles for moving people	Corridors, hallways, aisles, stairs, landings, etc. in institutional type buildings (not subject to crowds or wheeled vehicles), hostels, guest houses, residential clubs, and communal areas in blocks of flats not covered by Note 1. (For communal areas in blocks of flats covered by Note 1, see A)	Corridors, hallways, aisles, etc. (foot traffic only)	3.0	4.5
		Stairs and landings (foot traffic only)	3.0	4.0
	Corridors, hallways, aisles, stairs, landings, etc. in all other buildings including hotels and motels and institutional buildings	Corridors, hallways, aisles, etc. (foot traffic only)	4.0	4.5
		Corridors, hallways, aisles, etc., subject to wheeled vehicles, trolleys, etc.	5.0	4.5
		Stairs and landings (foot traffic only)	4.0	4.0
		Industrial walkways (light duty)	3.0	4.5
		Industrial walkways (general duty)	5.0	4.5
		Industrial walkways (heavy duty)	7.5	4.5
		Museum floors and art galleries for exhibition purposes	4.0 (see Note 4)	4.5
		Balconies (except as specified in A)	Same as adjacent rooms but with a minimum of 4.0	1.5/m run concentrated at the outer edge
		Fly galleries	4.5 kN/m run distributed uniformly over width	–
C4 Areas with possible physical activities (see clause 9)	Dance halls and studios, gymnasia, stages		5.0	3.6
	Drill halls and drill rooms		5.0	9.0
C5 Areas susceptible to overcrowding (see clause 9)	Assembly areas without fixed seating, concert halls, bars, places of worship and grandstands		5.0	3.6
	Stages in public assembly areas		7.5	4.5
D Shopping areas	Shop floors for the sale and display of merchandise		4.0	3.6

Minimum imposed floor loads – continued

Type of activity/ occupancy for part of the building or structure	Examples of specific use	UDL kN/m ²	Point load kN
E Warehousing and storage areas. Areas subject to accumulation of goods. Areas for equipment and plant	General areas for static equipment not specified elsewhere (institutional and public buildings)	2.0	1.8
	Reading rooms with book storage, e.g. libraries	4.0	4.5
	General storage other than those specified	2.4 per metre of storage height	7.0
	File rooms, filing and storage space (offices)	5.0	4.5
	Stack rooms (books)	2.4 per metre of storage height (6.5 kN/m ² min)	7.0
	Paper storage for printing plants and stationery stores	4.0 per metre of storage height	9.0
	Dense mobile stacking (books) on mobile trolleys, in public and institutional buildings	4.8 per metre of storage height (9.6 kN/m ² min)	7.0
	Dense mobile stacking (books) on mobile trucks, in warehouses	4.8 per metre of storage height (15 kN/m ² min)	7.0
	Cold storage	5.0 per metre of storage height (15 kN/m ² min)	9.0
	Plant rooms, boiler rooms, fan rooms, etc., including weight of machinery	7.5	4.5
Ladders	–	1.5 rung load	
F	Parking for cars, light vans, etc. not exceeding 2500 kg gross mass, including garages, driveways and ramps	2.5	9.0
G	Vehicles exceeding 2500 kg. Driveways, ramps, repair workshops, footpaths with vehicle access, and car parking	To be determined for specific use	



NOTES:

- Communal areas in blocks of flats with limited use refers to blocks of flats not more than three storeys in height and with not more than four self-contained dwelling units per floor accessible from one staircase.
- Where these same areas may be subjected to loads due to physical activities or overcrowding, e.g. a hotel dining room used as a dance floor, imposed loads should be based on occupancy C4 or C% as appropriate. Reference should also be made to Clause 9.
- Fixed seating is seating where its removal and use of the space for other purposes is improbable.
- Museums, galleries and exhibition spaces often need more capacity than this, sometimes up to 10 kN/m².

Source: BS 6399: Part 1: 1996.

Typical unit floor and roof loadings

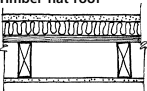
Permanent partitions shown on the floor plans should be considered as dead load. Flexible partitions which may be movable should be allowed for in imposed loads, with a minimum of 1 kN/m^2 .

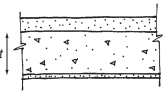
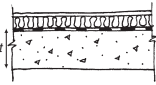
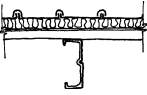
<p>Timber floor</p> 	<p>Live loading: domestic/office (Office partitions) $1.5/2.5 \text{ kN/m}^2$ (1.0) Timber boards/plywood 0.15 Timber joists 0.2 Ceiling and services 0.15</p> <p style="text-align: right;">Domestic/office totals $2.0/4.0 \text{ kN/m}^2$</p>
<p>Timber flat roof</p> 	<p>Snow and access 0.75 kN/m^2 Asphalt waterproofing 0.45 Timber joists and insulation 0.2 Ceiling and services 0.15</p> <p style="text-align: right;">Total 1.55 kN/m^2</p>
<p>Timber pitched roof</p> 	<p>Snow 0.6 kN/m^2 Slates, timber battens and felt 0.55 Timber rafters and insulation 0.2 Ceiling and services 0.15</p> <p style="text-align: right;">Total 1.5 kN/m^2</p>
<p>Internal RC slab</p> 	<p>Live loading: office/classroom/corridors, etc. $2.5/3.0/4.0 \text{ kN/m}^2$ Partitions 1.0 (minimum) 50 screed/75 screed/raised floor $1.2/1.8/0.4$ Solid reinforced concrete slab $24t$ Ceiling and services 0.15</p> <p style="text-align: right;">Total – kN/m^2</p>
<p>External RC slab</p> 	<p>Live loading: snow and access/office/bar $0.75/2.5/5.0 \text{ kN/m}^2$ Slabs/paving 0.95 Asphalt waterproofing and insulation 0.45 50 screed 1.2 Solid reinforced concrete slab $24t$ Ceiling and services 0.15</p> <p style="text-align: right;">Total – kN/m^2</p>
<p>Metal deck roofing</p> 	<p>Live loading: snow/wind uplift $0.6/-1.0 \text{ kN/m}^2$ Outer covering, insulation and metal deck liner 0.4 Purlins – 150 deep at 1.5 m c/c 0.3 Services 0.1 Primary steelwork: light beams/trusses $0.5-0.8/0.7-2.4$</p> <p style="text-align: right;">Total – kN/m^2</p>

Typical 'all up' loads

For very rough assessments of the loads on foundations, 'all up' loads can be useful. The best way is to 'weigh' the particular building, but very general values for small-scale buildings might be:

Steel clad steel frame	5–10 kN/m ²
Masonry clad timber frame	10–15 kN/m ²
Masonry walls and precast concrete floor slabs	15–20 kN/m ²
Masonry clad steel frame	15–20 kN/m ²
Masonry clad concrete frame	20–25 kN/m ²

Wind loading

BS 6399: Part 2 gives methods for determining the peak gust wind loads on buildings and their components. Structures susceptible to dynamic excitation fall outside the scope of the guidelines. While BS 6399 in theory allows for a very site-specific study of the many design parameters, it does mean that grossly conservative values can be calculated if the 'path of least resistance' is taken through the code. Unless the engineer is prepared to work hard and has a preferred 'end result' to aim for, the values from BS 6399 tend to be larger than those obtained from the now withdrawn wind code CP3: Chapter V: Part 2.

As wind loading relates to the size and shape of the building, the size and spacing of surrounding structures, altitude and proximity to the sea or open stretches of country, it is difficult to summarize the design methods. The following dynamic pressure values have been calculated (on a whole building basis) for an imaginary building 20 m × 20 m in plan and 10 m tall (with equal exposure conditions and no dominant openings) in different UK locations. The following values should not be taken as prescriptive, but as an idea of an 'end result' to aim for. Taller structures will tend to have slightly higher values and where buildings are close together, funnelling should be considered. Small buildings located near the bases of significantly taller buildings are unlikely to be sheltered as the wind speeds around the bases of tall buildings tends to increase.

Typical values of dynamic pressure, q in kN/m^2

Building location	Maximum q for prevailing south westerly wind kN/m^2	Minimum q for north easterly wind kN/m^2	Arithmetic mean q kN/m^2
Scottish mountain-top	3.40	1.81	2.60
Dover cliff-top	1.69	0.90	1.30
Rural Scotland	1.14	0.61	0.87
Coastal Scottish town	1.07	0.57	0.82
City of London high rise	1.03	0.55	0.80
Rural northern England	1.02	0.54	0.78
Suburban South-East England	0.53	0.28	0.45
Urban Northern Ireland	0.88	0.56	0.72
Rural Northern Ireland	0.83	0.54	0.74
Rural upland Wales	1.37	0.72	1.05
Coastal Welsh town	0.94	0.40	0.67
Conservative quick scheme value for most UK buildings	–	–	1.20

NOTE:

These are typical values which do not account for specific exposure or topographical conditions.

Barrier and handrail loadings

Minimum horizontal imposed loads for barriers, parapets, and balustrades, etc.

Type of occupancy for part of the building or structure	Examples of specific use	Line load kN/m	UDL on infill kN/m ²	Point load on infill kN
A Domestic and residential activities	(a) All areas within or serving exclusively one dwelling including stairs, landings, etc. but excluding external balconies and edges of roofs (see C3 ix)	0.36	0.5	0.25
	(b) Other residential (but also see C)	0.74	1.0	0.5
B and E Offices and work areas not included elsewhere including storage areas	(c) Light access stairs and gangways not more than 600 mm wide	0.22	n/a	n/a
	(d) Light pedestrian traffic routes in industrial and storage buildings except designated escape routes	0.36	0.5	0.25
	(e) Areas not susceptible to overcrowding in office and institutional buildings. Also industrial and storage buildings except as given above	0.74	1.0	0.5
C Areas where people may congregate: C1/C2 areas with tables or fixed seating	(f) Areas having fixed seating within 530 mm of the barrier, balustrade or parapet	1.5	1.5	1.5
	(g) Restaurants and bars	1.5	1.5	1.5
C3 Areas without obstacles for moving people and not susceptible to overcrowding	(h) Stairs, landings, corridors, ramps	0.74	1.0	0.5
	(i) External balconies and edges of roofs. Footways and pavements within building curtilage adjacent to basement/sunken areas	0.74	1.0	0.5
C5 Areas susceptible to overcrowding	(j) Footways or pavements less than 3 m wide adjacent to sunken areas	1.5	1.5	1.5
	(k) Theatres, cinemas, discotheques, bars, auditoria, shopping malls, assembly areas, studios. Footways or pavements greater than 3 m wide adjacent to sunken areas	3.0	1.5	1.5
	(l) Designated stadia*	See requirements of the appropriate certifying authority		
D Retail areas	(m) All retail areas including public areas of banks/building societies or betting shops. For areas where overcrowding may occur, see C5	1.5	1.5	1.5
F/G Vehicular	(n) Pedestrian areas in car parks including stairs, landings, ramps, edges or internal floors, footways, edges of roofs	1.5	1.5	1.5
	(o) Horizontal loads imposed by vehicles	See clause 11. (Generally $F \geq 150$ kN)		

* Designated stadia are those requiring a safety certificate under the Safety of Sports Ground Act 1975

Source: BS 6399: Part 1: 1996.

Minimum barrier heights

Use	Position	Height mm
Single family dwelling	(a) Barriers in front of a window	800
	(b) Stairs, landings, ramps, edges of internal floors	900
	(c) External balconies, edges of roofs	1100
All other uses	(d) Barrier in front of a window	800
	(e) Stairs	900
	(f) Balconies and stands, etc. having fixed seating within 530 mm of the barrier	800*
	(g) Other positions	1100

*Site lines should be considered as set out in clause 6.8 of BS 6180.

Source: BS 6180: 1999.

Selection of materials

Material	Advantage	Disadvantage
Aluminium	<p>Good strength to dead weight ratio for long spans</p> <p>Good corrosion resistance</p> <p>Often from recycled sources</p>	<p>Cannot be used where stiffness is critical</p> <p>Stiffness is a third of that of steel</p> <p>About two to three times the price of steel</p>
Concrete	<p>Design is tolerant to small, late alterations</p> <p>Integral fire protection</p> <p>Integral corrosion protection</p> <p>Provides thermal mass if left exposed</p> <p>Client pays as the site work progresses: 'pay as you pour'</p>	<p>Dead load limits scope</p> <p>Greater foundation costs</p> <p>Greater drawing office and detailing costs</p> <p>Only precasting can accelerate site work</p> <p>Difficult to post-strengthen elements</p> <p>Fair faced finish needs very skilled contractors and carefully designed joints</p>
Masonry	<p>Provides thermal mass</p> <p>The structure is also the cladding</p> <p>Can be decorative by using a varied selection of bricks</p> <p>Economical for low rise buildings</p> <p>Inherent sound, fire and thermal properties</p> <p>Easy repair and maintenance</p>	<p>Skilled site labour required</p> <p>Long construction period</p> <p>Less economical for high rise</p> <p>Large openings can be difficult</p> <p>Regular movements joints</p> <p>Uniform appearance can be difficult to achieve</p>
Steelwork	<p>Light construction reduces foundation costs</p> <p>Intolerant to late design changes</p> <p>Fast site programme</p> <p>Members can be strengthened easily</p> <p>Ideal for long spans and transfer structures</p>	<p>Design needs to be fixed early</p> <p>Needs applied insulation, fire protection and corrosion protection</p> <p>Skilled workforce required</p> <p>Early financial commitment required from client to order construction materials</p> <p>Long lead-ins</p> <p>Vibrations can govern design</p>
Timber	<p>Traditional/low-tech option</p> <p>Sustainable material</p> <p>Cheap and quick with simple connections</p> <p>Skilled labour not an absolute requirement</p> <p>Easily handled</p>	<p>Limited to 4-5 storeys maximum construction height</p> <p>Requires fire protection</p> <p>Not good for sound insulation</p> <p>Must be protected against insects and moisture</p> <p>Connections can carry relatively small loads</p>

Selection of floor construction

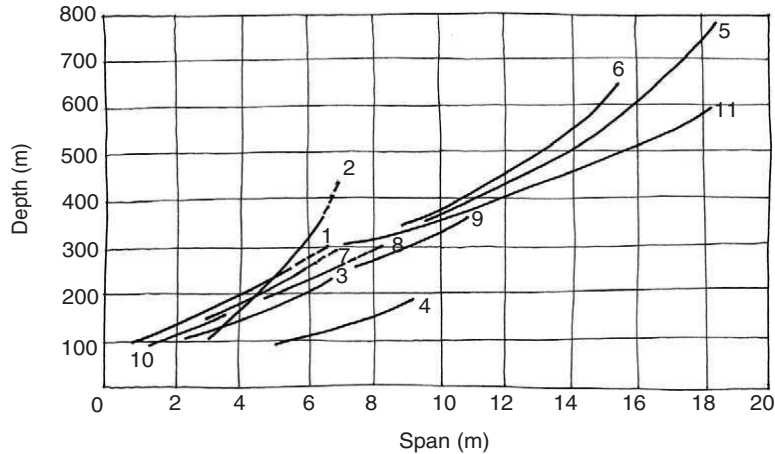

1. Timber joists at 400 c/c
2. Stressed skin ply panel
3. One way reinforced concrete slab
4. Precast prestressed concrete plank
5. Precast double tee beams
6. Coffered concrete slab
7. Beam + block floor
8. Reinforced concrete flat slab
9. Post tensioned flat slab
10. Concrete metal deck slab
11. Composite steel beams

Transportation

Although the transport of components is not usually the final responsibility of the design engineer, it is important to consider the limitations of the available modes of transport early in the design process using Department for Transport (DfT) information. Specific cargo handlers should be consulted for comment on sea and air transport, but a typical shipping container is 2.4 m wide, 2.4–2.9 m high and can be 6 m, 9 m, 12 m or 13.7 m in length. Transportation of items which are likely to exceed 20 m by 4 m should be very carefully investigated. Private estates may have additional and more onerous limitations on deliveries and transportation. Typical road and rail limitations are listed below as the most common form of UK transport, but the relevant authorities should be contacted to confirm the requirements for specific projects.

Rail transportation

Railtrack can carry freight in shipping containers or on flat bed wagons. The maximum load on a four axle flat wagon is 66 tonnes. The maximum height of a load is 3.9 m above the rails and wagons are generally between 1.4 and 1.8 m high. All special requirements should be discussed with Railtrack Freight or Network Rail.

Road transport

The four main elements of legislation which cover the statutory controls on length, width, marking, lighting and police notification for large loads are the Motor Vehicles (Construction & Use) Regulations 1986; the Motor Vehicles (Authorization of Special Types) General Order 1979, the Road Vehicles Lighting Regulations 1989 and the Road Traffic Act 1972. A summary of the requirements is set out below.

Height of load

There is no statutory limit governing the overall height of a load; however, where possible it should not exceed 4.95 m from the road surface to maximize use of the motorway and trunk road network (where the average truck flat bed is about 1.7 m). Local highway authorities should be contacted for guidance on proposed routes avoiding head height restrictions on minor roads for heights exceeding 3.0 m–3.6 m.

Weight of vehicle or load

Gross weight of vehicle, <i>W</i> kg	Notification requirements
$44\,000 < W \leq 80\,000$ or has any axle weight greater than permitted by the Construction & Use Regulations	2 days' clear notice with indemnity to the Highway and Bridge Authorities
$80\,000 < W \leq 150\,000$	2 days' clear notice to the police and 5 days' clear notice with Indemnity to the Highway and Bridge Authorities
$W > 150\,000$	DfT Special Order BE16 (allow 10 weeks for application processing) plus 5 days' clear notice to the police and 5 days' clear notice with indemnity to the Highway and Bridge Authorities

Width of load

Total loaded width*, B m	Notification requirements
$B \leq 2.9$	No requirement to notify police
$2.9 < B \leq 5.0$	2 days' clear notice to police
$5.0 < B \leq 6.1$	DfT permission VR1 (allow 10 days for application processing) and 2 days' clear notice to police
$B > 6.1$	DfT Special Order BE16 (allow 8 weeks for application processing) and 5 days' clear notice to police and 5 days' clear notice with indemnity to Highway and Bridge Authorities

* A load may project over one or both sides by up to 0.305 m, but the overall width is still limited as above.

Loads with a width of over 2.9 m or with loads projecting more than 0.305 m on either side of the vehicle must be marked to comply with the requirements of the Road Vehicles Lighting Regulations 1989.

Length of load

Total loaded length, L m	Notification requirements
$L < 18.75$	No requirement to notify police
$18.75 \leq L < 27.4$	Rigid or articulated vehicles*. 2 days' clear notice to police
(rigid vehicle) $L > 27.4$	DfT Special Order BE16 (allow 8 weeks for application processing) and 5 days' clear notice to police and 5 days' clear notice with indemnity to Highway and Bridge Authorities
(all other trailers) $L > 25.9$	All other trailer combinations carrying the load. 2 days' clear notice to police



* The length of the front of an articulated motor vehicle is excluded if the load does not project over the front of the motor vehicle.

Projection of overhanging loads

Overhang position	Overhang length, L m	Notification requirements
Rear	$L < 1.0$	No special requirement
	$1.0 < L < 2.0$	Load must be made clearly visible
	$2.0 < L < 3.05$	Standard end marker boards are required
	$L > 3.05$	Standard end marker boards are required plus police notification and an attendant is required
Front	$L < 1.83$	No special requirement
	$2.0 < L < 3.05$	Standard end marker boards are required plus the driver is required to be accompanied by an attendant
	$L > 3.05$	Standard end marker boards are required plus police notification and the driver is required to be accompanied by an attendant

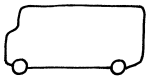
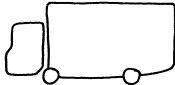
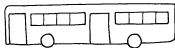
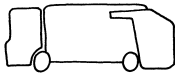
Typical vehicle sizes and weights

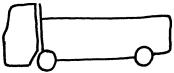
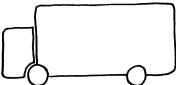
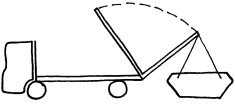
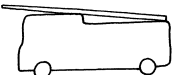
Vehicle type		Weight, <i>W</i> kg	Length, <i>L</i> m	Width, <i>B</i> m	Height, <i>H</i> m	Turning circle m
3.5 tonne van		3500	5.5	2.1	2.6	13.0
7.5 tonne van		7500	6.7	2.5	3.2	14.5
Single decker bus		16 260	11.6	2.5	3.0	20.0
Refuse truck		16 260	8.0	2.4	3.4	17.0

2 axle tipper		16 260	6.4	2.5	2.6	15.0
Van (up to 16.3 tonnes)		16 260	8.1	2.5	3.6	17.5
Skiploader		16 260	6.5	2.5	3.7	14.0
Fire engine		16 260	7.0	2.4	3.4	15.0
Bendy bus		17 500	18.0	2.6	3.1	23.0

Temporary works toolkit

Steel trench prop load capacities

Better known as 'Acrow' props, these adjustable props should conform to BS 4704 or BS EN 1065. Verticality of the loads greatly affects the prop capacity and fork heads can be used to eliminate eccentricities. Props exhibiting any of the following defects should not be used:

- A tube with a bend, crease or noticeable lack of straightness.
- A tube with more than superficial corrosion.
- A bent head or base plate.
- An incorrect or damaged pin.
- A pin not properly attached to the prop by the correct chain or wire.

Steel trench 'acrow' prop sizes and reference numbers to BS 4074

Prop size/reference*	Height range	
	Minimum m	Maximum m
0	1.07	1.82
1	1.75	3.12
2	1.98	3.35
3	2.59	3.96
4	3.20	4.87

*The props are normally identified by their length.

Steel trench prop load capacities

A prop will carry its maximum safe load when it is plumb and concentrically loaded as shown in the charts in BS 4074. A reduced safe working load should be used for concentric loading with an eccentricity, $e \leq 1.5^\circ$ out of plumb as follows:

Capacity of props with $e \leq 1.5^\circ$ (KN)

Height m	≤2.75	3.00	3.25	3.50	3.75	4.00	4.25	4.50	4.75
Prop size 0, 1, 2 and 3	17	16	13	11	10	–	–	–	–
Prop size 4	–	–	17	14	11	10	9	8	7

Soldiers

Slim soldiers, also known as slimshors, can be used horizontally and vertically and have more load capacity than steel trench props. Lengths of 0.36 m, 0.54 m, 0.72 m, 0.9 m, 1.8 m, 2.7 m or 3.6 m are available. Longer units can be made by joining smaller sections together. A connection between units with four M12 bolts will have a working moment capacity of about 12 kNm, which can be increased to 20 kNm if stiffeners are used.

Slimshor section properties

Area cm ²	I_{xx} cm ⁴	I_{yy} cm ⁴	Z_{xx} cm ³	Z_{yy} cm ³	r_x cm	r_y cm	$M_{max,y}$ kNm	$M_{max,x}$ kNm
19.64	1916	658	161	61	9.69	5.70	38	7.5

Slimshor compression capacity

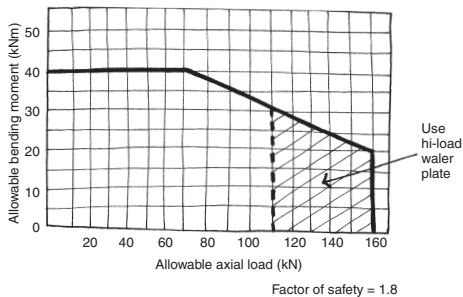
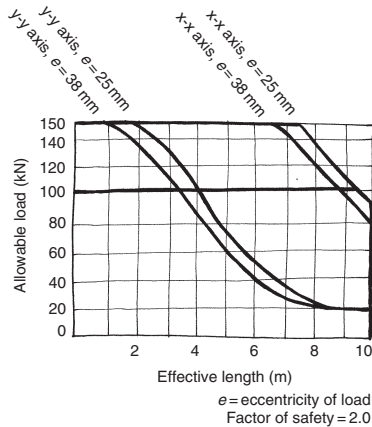

Slimshor moment capacity

Source: RMD Kwikform (2002).

Ladder beams

Used to span horizontally in scaffolding or platforms, ladder beams are made in 48.3 ϕ 3.2 CHS, 305 mm deep, with rungs at 305 mm centres. All junctions are saddle welded. Ladder beams can be fully integrated with scaffold fittings. Bracing of both the top and bottom chords is required to prevent buckling. Standard lengths are 3.353 m (11'), 4.877 m (16') and 6.400 m (21').

Manufacturers should be contacted for loading information. However, if the tension chord is tied at 1.5 m centres and the compression chord is braced at 1.8 m centres the moment capacity for working loads is about 8.5 kNm. If the compression chord bracing is reduced to 1.5 m centres, the moment capacity will be increased to about 12.5 kNm. The maximum allowable shear is about 12 kN.

Unit beams

Unit beams are normally about 615 mm deep, are about 22.5 times stronger than ladder beams and are arranged in a similar way to a warren girder. Loads should only be applied at the node points. May be used to span between scaffolding towers or as a framework for temporary buildings. As with ladder beams, bracing of both the top and bottom chords is required to prevent buckling, but diagonal plan bracing should be provided to the compression flange. Units can be joined together with M24 bolts to make longer length beams. Standard lengths are 1.8 m (6'), 2.7 m (9') and 3.6 m (12')

Manufacturers should be contacted for loading information. However, if the tension chord is tied at 3.6 m centres and the compression chord is braced at 2.4 m centres the moment capacity for working loads is about 13.5 kNm. If the compression bracing is reduced to 1.2 m centres, the moment capacity will be increased to about 27.5 kNm. The maximum allowable shear is about 14 kN.

4

Basic and Shortcut Tools for Structural Analysis

Load factors and limit states

There are two design considerations: strength and stiffness. The structure must be strong enough to resist the worst loading conditions without collapse and be stiff enough to resist normal working conditions without excessive deflection or deformation. Typically the requirements for strength and stiffness are split between the following 'limit states':

Ultimate limit state (ULS) – Strength (including yielding, rupture, buckling and forming a mechanism), stability against overturning and swaying, fracture due to fatigue and brittle fracture.

Serviceability limit state (SLS) – Deflection, vibration, wind induced oscillation and durability.

A factor of safety against structural failure of 2.0 to 10.0 will be chosen depending on the materials and workmanship. There are three main methods of applying the factor of safety to structural design:

Allowable or permissible stress design – Where the ultimate strengths of the materials are divided by a factor of safety to provide design stresses for comparison with unfactored loads. Normally the design stresses stay within the elastic range. This method is not strictly applicable to plastic (e.g. steel) or semi-plastic (e.g. concrete or masonry) materials and there is one factor of safety to apply to all conditions of materials, loading and workmanship. This method has also been found to be unsafe in some conditions when considering the stability of structures in relation to overturning.

Load factor design – Where working loads are multiplied by a factor of safety for comparison with the ultimate strength of the materials. This method does not consider variability of the materials and as it deals with ultimate loads, it cannot be used to consider deflection and serviceability under working loads.

Ultimate loads or limit state design – The applied loads are multiplied by partial factors of safety and the ultimate strengths of the materials are divided by further partial factors of safety to cover variation in the materials and workmanship. This method allows a global factor of safety to be built up using the partial factors at the designer's discretion, by varying the amount of quality control which will be available for the materials and workmanship. The designer can therefore choose whether to analyse the structure with working loads in the elastic range, or in the plastic condition with ultimate loads. Serviceability checks are generally made with unfactored, working loads.

Geometric section properties

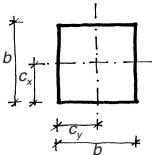
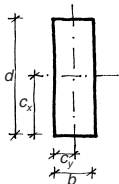
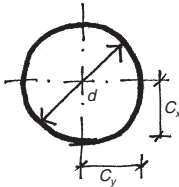
Section	A mm ²	C _x mm	C _y mm	I _x cm ³	I _y cm ³	J (approx.) cm ⁴
	b^2	$\frac{b}{2}$	$\frac{b}{2}$	$\frac{b^4}{12}$	$\frac{b^4}{12}$	$\frac{5b^4}{36}$
	bd	$\frac{d}{2}$	$\frac{b}{2}$	$\frac{bd^3}{12}$	$\frac{db^3}{12}$	$\frac{d^3}{3} 16b - d \left(1 - \frac{d^4}{12b^4}\right)$ for $a > b$
	$\frac{\pi d^2}{4}$	$\frac{d}{2}$	$\frac{d}{2}$	$\frac{\pi d^4}{64}$	$\frac{\pi d^4}{64}$	$\frac{\pi d^4}{32}$

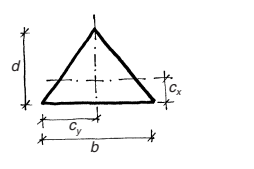
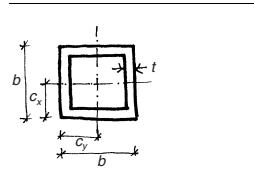
	$\frac{bd}{2}$	$\frac{d}{3}$	$\frac{b}{2}$	$\frac{bd^3}{36}$	$\frac{db^3}{48}$	$\frac{b^3d^3}{(15b^2 + 20d^2)}$
	$b^2 - (b - 2t)^2$	$\frac{b}{2}$	$\frac{b}{2}$	$\frac{b^4 - (b - 2t)^4}{12}$	$\frac{b^4 - (b - 2t)^4}{12}$	$(b - t)^3 t$

Elastic modulus I/y , plastic modulus, S = sum of first moments of area about central axis, the shape factor = S/Z

Geometric section properties – continued

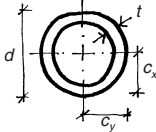
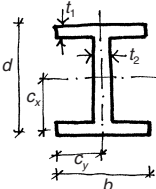
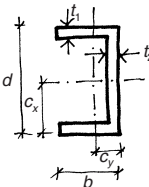
Section	A mm ²	C _x mm	C _y mm	I _x cm ³	I _y cm ³	J (approx.) cm ⁴
	$\frac{\pi(d^2 - (d - 2t)^2)}{4}$	$\frac{d}{2}$	$\frac{d}{2}$	$\frac{\pi(d^4 - (d - 2t)^4)}{64}$	$\frac{\pi(d^4 - (d - 2t)^4)}{64}$	$\frac{\pi(d - t)^3 t}{4}$
	$2bt_1 + t_2(d - 2t_1)$	$\frac{d}{2}$	$\frac{b}{2}$	$\frac{bd^3 - (b - t_2)(d - 2t_1)^3}{12}$	$\frac{2t_1b^3 - (d - 2t_1)t_2^3}{12}$	$\frac{2t_1^3b - t_2^3d}{3}$
	$bd - (d - 2t_1)(b - t_2)$	$\frac{d}{2}$	$\frac{2b^2t_1 + (d - 2t_1)t_2^2}{2(2bt_1 + (d - 2t_1)t_2)}$	$\frac{bd^3 - (b - t_2)(d - 2t_1)^3}{12}$	$\frac{2t_1b^3 - (d - 2t_1)t_2^3}{12} + 2bt_1\left(\frac{b}{2} - C_y\right)^2 + t_2(d - 2t_1)\left(C_y - \frac{t_2}{2}\right)^2$	$\frac{t^3(d + 2b)}{3}$

	$bt_1 + (d - t_1)t_2$	$\frac{bt_1\left(d - \frac{t_1}{2}\right) + \frac{1}{2}(d - t_1)^2 t_2}{A}$	$\frac{b}{2}$	$\frac{bt_1^3 + t_2(d - t_1)^3}{12}$ $+ bt_1\left(d - C_x - \frac{t_1}{2}\right)^2$ $+ t_2(d - t_1)\left(C_x - \frac{d - t_1}{2}\right)^2$	$\frac{t_1 b^3 - (d - t_1)t_2^3}{12}$	$\frac{t_1^3 b - t_2^3 d}{3}$
	$dt_2 + (b - t_2)t_1$	$\frac{d^2 t_2 (b - t_2) t_1^2}{2A}$	$\frac{b^2 t_1 (d - t_1) t_2^2}{2A}$	$\frac{t_2 d^3 - (b - t_2)t_1^3 (d - 2t_1)^3}{12}$ $+ dt_2\left(\frac{d}{2} - C_x\right)^2$ $+ (b - t_2)t_1\left(C_x - \frac{t_1}{2}\right)^2$	$\frac{t_1 b^3 + (d - t_1)t_2^3}{12}$ $+ bt_1\left(\frac{b}{2} - C_y\right)^2$ $+ (d - t_1)t_2\left(C_y - \frac{t_2}{2}\right)^2$	$\frac{t_1^3 b - t_2^3 d}{3}$

Elastic modulus I_y , plastic modulus, $S = \text{sum of first moments of area about central axis}$, the shape factor $= S/Z$

Parallel axis theorem

$$y = \frac{\sum A_i y_i}{\sum A} \quad I_{xx} = \sum A_i (y - y_i)^2 + \sum I_c$$

Where:

y_i neutral axis depth of element from datum

y depth of the whole section neutral axis from the datum

A_i area of element

A area of whole section

I_{xx} moment of inertia of the whole section about the x - x axis

I_c moment of inertia of element

Composite sections

A composite section made of two materials will have a strength and stiffness related to the properties of these materials. An equivalent stiffness must be calculated for a composite section. This can be done by using the ratios of the Young's moduli to 'transform' the area of the weaker material into an equivalent area of the stronger material.

$$\alpha_E = \frac{E_1}{E_2} \quad \text{For concrete to steel, } \alpha_E \cong 15$$

For timber to steel, $\alpha_E \cong 35$

Typically the depth of the material (about the axis of bending) should be kept constant and the breadth should be varied: $b_1 = \alpha_E b_2$. The section properties and stresses can then be calculated based on the transformed section in the stronger material.

Material properties

Homogeneous: same elastic properties throughout. Isotropic: same elastic properties in all directions. Anisotropic: varying elastic properties in two different directions. Orthotropic: varying elastic properties in three different directions. All properties are given for a temperature of 20°C.

Properties of selected metals

Material	Specific weight γ kN/m ³	Modulus of elasticity E kN/mm ²	Shear modulus of elasticity G kN/mm ²	Poisson's ratio ν	Proof or yield stress f_y N/mm ²	Ultimate strength* $f_{y, ult}$ N/mm ²	Elongation at failure %
Aluminium pure	27	69	25.5	0.34	<25	<58	30–60
Aluminium alloy	27.1	70	26.6	0.32	130–250		
Aluminium bronze AB1	77	120	46	0.30	170–200	500–590	18–40
AB2					250–360	640–700	13–20
Copper	89	96	38	0.35	60–325	220–385	
Brass	84.5	102	37.3	0.35	290–300	460–480	
Naval brass (soft-hard)	84	100	39	0.34	170–140	410–590	30–15
Bronze	82–86	96–120	36–44	0.34	82–690	200–830	5–60
Phosphor bronze	88	116	43	0.33	–	410	15
Mild steel	78.5	205	82.2	0.3	275–355	430–620	20–22
Stainless steel 304L	78–80	205	76.9	0.3	210	520–720	45
Stainless steel duplex 2205	78–80	205	76.9	0.3	460	640–840	20
Grey cast iron	72	130	48	–	–	150/600c	–
Blackheart cast iron	73.5	170	68	0.26	180	260/780c	10–14
Wrought iron	74–78	190	75	0.3	210	340	35

*Ultimate tensile strength labelled c which denotes ultimate compressive stress.

Properties of selected stone, ceramics and composites

Material	Specific weight γ kN/m ³	Modulus of elasticity E kN/mm ²	Poisson's ratio ν	Characteristic crushing strength f_{cu} N/mm ²	Ultimate tensile strength f_{yult} N/mm ²
Carbon fibre (7.5 mm ϕ)	20	415			1750
Concrete	24	17–31	0.1–0.2	10–70	
Concrete blocks	5–20			3–20	
Clay brick	22.5–28	5–30		10–90	
Fibre glass	15	10*		150	100
Glass (soda)	24.8	74	0.22	1000	30–90
Glass (float)	25–25.6	70–74	0.2–0.27	1000	45 annealed 120–150 toughened
Granite	26	40–70	0.2–0.3	70–280	
Limestone	20–29	20–70	0.2–0.3	20–200	
Marble	26–29	50–100	0.2–0.3	50–180	

Properties of selected timber*

Material	Specific weight γ kN/m ³	Modulus of elasticity E kN/mm ²	Ultimate tensile strength f_{yult} N/mm ²	Ultimate compressive strength f_{cuult} N/mm ²	Ultimate shear strength f_{vult} N/mm ²
Ash	6.5	10	60	48	10
Beech	7.4	10	60–110	27–54	8–14
Birch	7.1	15	85–90	67–74	13–18
English elm	5.6	11	40–54	17–32	8–11
Douglas fir	4.8–5.6	11–13	45–73	49–74	7.4–8.8
Mahogany	5.4	8	60	45	6
Oak	6.4–7.2	11–12	56–87	27–50	12–18
Scots pine	5.3	8–10	41.8	21–42	5.2–9.7
Poplar	4.5	7	40–43	20	4.8
Spruce	4.3	7–9	36–62	18–39	4.3–8
Sycamore	6.2	9–14	62–106	26–46	8.8–15

*These values are ultimate values. See the chapter on timber for softwood and hardwood design stresses.

Properties of selected polymers and plastics

Material	Specific weight γ kN/m ³	Modulus of elasticity E kN/mm ²	Ultimate tensile strength f_y^{ult} N/mm ²	Elongation at failure – %
Polythene HD	9–14	0.55–1	20–37	20–100
PVC	13–14	2.4–3.0	40–60	200
PVC plasticized	13–14	0.01	150	
Polystyrene	10–13	3–3.3	35–68	3
Perspex	12	3.3	80–90	6
Acrylic	11.7–12	2.7–3.2	50–80	2–8
PTFE	21–22	0.3–0.6	20–35	100
Polycarbonate	12	2.2–4	50–60	100–130
Nylon	11.5	2–3.5	60–110	50
Rubber	9.1	0.002–0.1	7–20	100–800
Epoxy resin	16–20	20	68–200	4
Neoprene		0.7–20	3.5–24	
Carbon fibre		240	3.5	1.4
Kevlar 49		125	3	2.8
Polyester fabric + PVC coat	14	14	900	14–20

Coefficients of linear thermal expansion

Amount of linear thermal expansion, $l_{\text{thermal}} = \alpha(t_{\text{max}} - t_{\text{min}})l_{\text{overall}}$. A typical internal temperature range for the UK might be: -5°C to 35°C . Externally this might be more like -15°C to 60°C to allow for frost, wind chill and direct solar gain.

Material	α $10^{-6}/^{\circ}\text{C}$
Aluminium	24
Aluminium bronze	17
Brass	18–19
Bronze	20
Copper	17
Float glass	8–9
Cast iron	10–11
Wrought iron	12
Mild steel	12
Stainless steel – austenitic	18
Stainless steel – ferritic	10
Lead	29
Wood – parallel to the grain	3
Wood – perpendicular to the grain	30
Zinc	26
Stone – granite	8–10
Stone – limestone	3–4
Stone – marble	4–6
Stone – sandstone	7–12
Concrete – dense gravel aggregate	10–14
Concrete – limestone aggregate	7–8
Plaster	18–21
Clay bricks	5–8
Concrete blocks	6–12
Polycarbonate	60–70
GRP (polyester/glass fibre)	18–25
Rigid PVC	42–72
Nylon	80–100
Asphalt	30–80

Coefficients of friction

The frictional force, $F = \mu N$, where N is the force normal to the frictional plane.

Materials	Coefficient of friction μ
Metal on metal	0.15–0.60
Metal on hardwood	0.20–0.60
Wood on wood	0.25–0.50
Rubber on paving	0.70–0.90
Nylon on steel	0.30–0.50
PTFE on steel	0.05–0.20
Metal on ice	0.02
Masonry on masonry	0.60–0.70
Masonry on earth	0.50
Earth on earth	0.25–1.00

Sign conventions

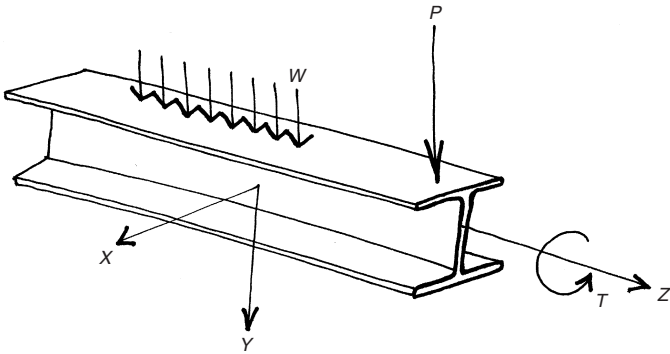

When members are cut into sections for the purpose of analysis, the cut section can be assumed to be held in equilibrium by the internal forces. A consistent sign convention like the following should be adopted:

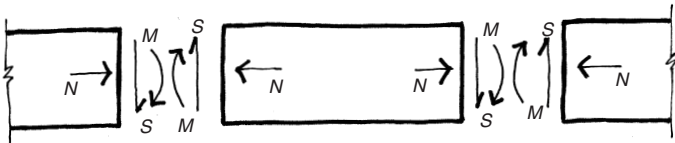

A positive bending moment, M , results in tension in the bottom of the beam, causing the upper face of the beam to be concave. Therefore this is called a sagging moment. A negative bending moment is called a hogging moment. A tensile axial force, N , is normally taken as positive. Shear force, S , 'couples' are normally considered positive when they would result in a clockwise rotation of the cut element. A positive torque, T , is generally in an anti-clockwise direction.

Beam bending theory

$$\text{Moment: } M = -EI \frac{d^2y}{dx^2}$$

$$\text{Shear: } Q = \frac{dM}{dx}$$

Elastic constants

Hooke's law defines Young's modulus of elasticity, $E = \sigma/\epsilon$. Young's modulus is an elastic constant to describe linear elastic behaviour, where σ is stress and ϵ is the resulting strain. Hooke's law in shear defines the shear modulus of elasticity, $G = \tau/\gamma$, where τ is the shear stress and γ is the shear strain. Poisson's ratio, $\nu = \epsilon_{\text{lateral}}/\epsilon_{\text{axial}}$, relates lateral strain over axial strain for homogeneous materials. The moduli of elasticity in bending and shear are related by: $G = E/(2(1 + \nu))$ for elastic isotropic materials. As ν is normally from 0 to 1.5, G is normally between 0.3 and 0.5 of E .

Elastic bending relationships

$$\frac{M}{I} = \frac{\sigma}{y} = \frac{E}{R}$$

Where M is the applied moment, I is the section moment of inertia, σ is the fibre bending stress, y is the distance from the neutral axis to the fibre and R is the radius of curvature. The section modulus, $Z = I/y$ and the general equation can be simplified so that the applied bending stress, $\sigma = M/Z$.

Horizontal shear stress distribution

$$\tau = \frac{Qy}{bl}$$

Where τ is the horizontal shear stress, Q is the applied shear, b is the breadth of the section at the cut line being considered and A is the area of the segment above the cut line; I is the second moment of area of whole section and y is the distance from centre of area above the cut line to centroid of whole section.

Horizontal shear stresses have a parabolic distribution in a rectangular section. The average shear stress is about 60% of the peak shear (which tends to occur near the neutral axis).

Deflection limits

Typical vertical deflection limits

Total deflection	span/250
Live load deflection	span/360
Domestic timber floor joists	span/360 or 14 mm
Deflection of brittle elements	span/500
Cantilevers	span/180
Vertical deflection of crane girders due to static vertical wheel loads from overhead travelling cranes	span/600
Purlins and sheeting rails (dead load only)	span/200
Purlins and sheeting rails (worst case dead, imposed, wind and snow)	span/100

Typical horizontal deflection limits

Sway of single storey columns	height/300
Sway of each storey of multi-storey column	height/300
Sway of columns with movement sensitive cladding	height/500
Sway of portal frame columns (no cranes)	to suit cladding
Sway of portal frame columns (supporting crane runways)	to suit crane runway
Horizontal deflection of crane girders (calculated on the top flange properties alone) due to horizontal crane loads	span/500
Curtain wall mullions and transoms (single glazed)	span/175
Curtain wall mullions and transoms (double glazed)	span/250

Beam bending and deflection formulae

P is a point load in kN, W is the total load in kN on a span of length L and w is a distributed load in kN/m.

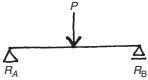
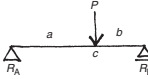
Loading condition	Reactions	Maximum moments	End slope	Maximum deflection
	$R_A = R_B = \frac{P}{2}$	$M_{\text{midspan}} = \frac{PL}{4}$	$\phi_A = \phi_B = \frac{WL^2}{16EI}$	$\delta_{\text{midspan}} = \frac{PL^3}{48EI}$
	$R_A = \frac{Pb}{L}$ $R_B = \frac{Pa}{L}$	$M_c = \frac{Pab}{L}$	$\phi_A = \frac{Pab}{6EI}(L + b)$ $\phi_B = \frac{Pab}{6EI}(L + a)$	When $a > b$, $\delta_x = \frac{Pab(L + b)}{27EI} \sqrt{3a(L + b)}$ at $x = \sqrt{\frac{a(L + b)}{3}}$ from A

Beam bending and deflection formulae – continued

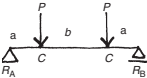
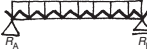
Loading condition	Reactions	Maximum moments	End slope	Maximum deflection
	$R_A = R_B = P$	$M_c = Pa$	$\phi_A = \phi_B = \frac{Pa}{2EI}(L - a)$	$\delta_{\text{midspan}} = \frac{Pa}{24EI}(3L^2 - 4a^2)$
	$R_A = R_B = \frac{W}{2}$	$M_{\text{midspan}} = \frac{WL}{8}$	$\phi_A = \phi_B = \frac{WL^2}{24EI}$	$\delta_{\text{midspan}} = \frac{5WL^3}{384EI}$

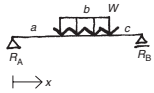

$$\text{Let } r = \frac{0.5b + c}{L}$$



$$R_A = Wr$$

$$R_B = W(1 - r)$$

$$R_A = R_B = \frac{W}{2}$$

$$M_x = Wr(a + 0.5rb)$$

 at $x = (a + rb)$ from A

$$M_{\text{midspan}} = \frac{WL}{6}$$

$$\phi_A = \frac{Wr}{6EI}(L^2 - c^2 + Lbr)$$

$$\phi_B = \frac{W(1-r)}{6EI}S$$

$$\text{where } S = (L^2 - a^2 - Lb(1-r))$$

$$\phi_A = \phi_B = \frac{5WL^2}{96EI}$$

Where $a \leq x = a + b$

$$\delta_x = \frac{W}{24EIb} [x^4 - 4(a+rb)x^3 + 6a^2x^2 + K]$$

$$\text{where } K = 4rb \left(L^2 - c^2 - cb - \frac{b^2}{2} \right) - a^3(x+a^4)$$

$$\delta_{\text{midspan}} = \frac{WL^3}{60EI}$$

Beam bending and deflection formulae – continued

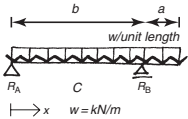
Loading condition	Reactions	Maximum moments	End slope	Maximum deflection
	$R_A = \frac{W}{3}$ $R_B = \frac{2W}{3}$	$M_x = \frac{Wx(L^2 - x^2)}{3L^2}$	–	$\delta_{\text{midspan}} = \frac{5WL^3}{384EI}$
	$R_A = \frac{W}{2a}(a^2 - b^2)$ $R_B = \frac{W}{2a}(a + b)^2$	$M_B = \frac{wb^2}{2}$ $M_C = \frac{w(a+b)^2(a-b)^2}{8a^2}$ <p style="text-align: center;">maximum at $x = \frac{a}{2} \left(1 - \frac{b^2}{a^2}\right)$</p>	–	$\delta_{\text{between supports}} = \frac{wx}{24EI} \frac{a^4 - 2a^2x_1^2 + ax_1^3 + 2a^2b^2 + 2b^2x_1^2}{}$ $\delta_{\text{free tip}} = \frac{wb}{24EI}(3b^3 + 4ab^2 - a^3)$

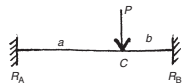

$a > b$

$$R_A = \frac{Pb^2(L + 2a)}{L^3}$$

$$R_B = \frac{Pa^2(L + 2b)}{L^3}$$

$$M_A = \frac{-Pab^2}{L^2}$$

$$M_B = \frac{-Pba^2}{L^2}$$

$$M_C = \frac{2Pa^2b^2}{L^3}$$

$$\phi_A = \phi_B = 0$$

$$\delta_{\text{midspan}} = \frac{2Pa^3b^2}{3EI(L + 2a)^2}$$

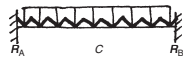

$$R_A = R_B = \frac{W}{2}$$

$$M_A = M_B = \frac{-WL}{12}$$

$$M_C = \frac{WL}{24}$$

$$\phi_A = \phi_B = 0$$

$$\delta_{\text{midspan}} = \frac{WL^3}{384EI}$$

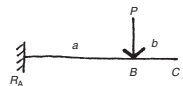

$$R_A = P$$

$$M_A = -Pa$$

$$\phi_A = 0$$

$$\phi_B = \phi_C = \frac{Wa^2}{2EI}$$

$$\delta_C = \frac{Wa^2}{3EI} \left(L + \frac{b}{2} \right)$$

Beam bending and deflection formulae – continued

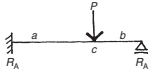
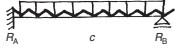
Loading condition	Reactions	Maximum moments	End slope	Maximum deflection
	$R_A = W$	$M_A = \frac{-WL}{2}$	$\phi_A = 0$ $\phi_B = \frac{WL^2}{6EI}$	$\delta_{\text{midspan}} = \frac{WL^3}{8EI}$
	$R_A = \frac{Pb(3L^2 - b^2)}{2L^3}$ $R_B = \frac{Pa^2(2L + b)}{2L^3}$	$M_A = \frac{-Pab(L + b)}{2L^2}$ $M_C = \frac{Pa^2b(2L + b)}{2L^3}$	$\phi_A = 0$ $\phi_B = \frac{Wa^2b}{4EI}$	$a = b\sqrt{2} \quad \delta_{C_{\text{max}}} = \frac{WL^3}{102EI}$ $a > b\sqrt{2} \quad \delta_{AC} = \frac{Wa^3b(L + B)^3}{3EI(3L^2 - b^2)^2}$ $a < b\sqrt{2} \quad \delta_{CB} = \frac{Wa^2b}{6EI} \sqrt{\frac{b}{2L + b}}$
	$R_A = \frac{5W}{8}$ $R_B = \frac{3W}{8}$	$M_A = \frac{-WL}{8}$ $M_D = \frac{9WL}{128} \text{ at } 0.62L \text{ from A}$	$\phi_A = 0$ $\phi_B = \frac{WL^2}{48EI}$	$\delta_{\text{max}} = \frac{WL^3}{185EI} \text{ at } 0.58L \text{ from A}$

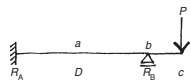

$$R_A = \frac{-3Pb}{2a}$$

$$R_B = \frac{P}{a} \left(L + \frac{b}{2} \right)$$

$$M_A = \frac{Pb}{2}$$

$$M_B = -Pb$$

$$\phi_A = 0$$

$$\phi_C = \frac{Wb}{4EI} (L + b)$$

$$\delta_C = \frac{Pb^2}{4EI} \left(L + \frac{b}{3} \right)$$

$$\delta_D = \frac{-Pa^2b}{27EI} \text{ at } 0.66L$$

Clapeyron's equations of three moments

Clapeyron's equations can be applied to continuous beams with three supports, or to two-span sections of longer continuous beams.

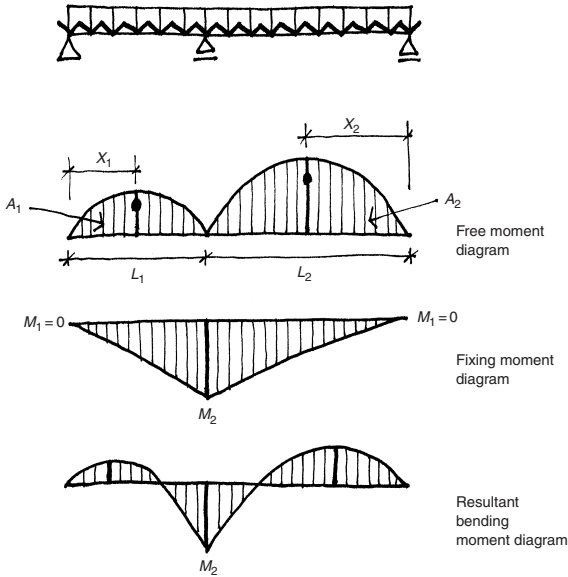

General equation

$$\frac{M_1 L_1}{I_1} + 2M_2 \left(\frac{L_1}{I_1} + \frac{L_2}{I_2} \right) + \frac{M_3 L_2}{I_2} = 6 \left(\frac{A_1 \bar{x}_1}{L_1 I_1} + \frac{A_2 \bar{x}_2}{L_2 I_2} \right) + 6E \left(\frac{y_2}{L_1} + \frac{y_2 - y_3}{L_2} \right)$$

Where:

M bending moment

A area of 'free' moment diagram if the span is treated as simply supported

L span length

\bar{x} distance from support to centre of area of the moment diagram

I second moment of area

y deflections at supports due to loading

Usual case: level supports and uniform moment of area

$$M_1 L_1 + 2M_2(L_1 + L_2) + M_3 L_2 = 6 \left(\frac{A_1 \bar{x}_1}{L_1} + \frac{A_2 \bar{x}_2}{L_2} \right)$$

where $y_1 = y_2 = y_3 = 0$ and $I_1 = I_2 = I_3$

M_1 and M_3 are either: unknown for fixed supports, zero for simple supports or known cantilever end moments, and can be substituted into the equation to provide a value for M_2 .

Free ends: $M_1 = M_3 = 0$

$$2M_2(L_1 + L_2) = 3 \left(\frac{A_1 \bar{x}_1}{L_1} + \frac{A_2 \bar{x}_2}{L_2} \right)$$

which can be further simplified to

$$M_2 = \frac{W(L_1^3 + L_2^3)}{8(L_1 + L_2)}$$

Multiple spans

The general case can be applied to groups of three supports for longer continuous beams with n spans. This will produce $(n - 2)$ simultaneous equations which can be resolved to calculate the $(n - 2)$ unknown bending moments.

Continuous beam bending formulae

Moments of inertia are constant and all spans of L metres are equal. W is the total load on one span (in kN) from either distributed or point loads.

Reaction = coefficient $\times W$

Moment = coefficient $\times W \times L$

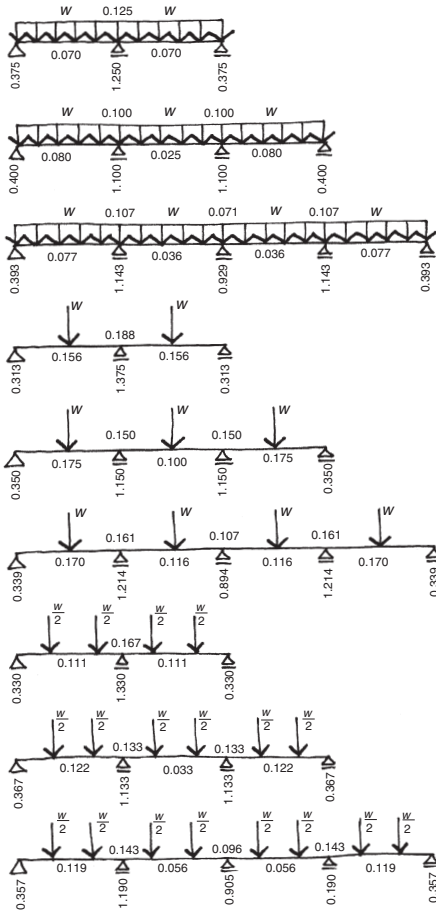

Struts

The critical buckling load of a strut is the applied axial load which will cause the strut to buckle elastically with a sideways movement. There are two main methods of determining this load: Euler's theory, which is simple to use or the Perry–Robertson theory, which forms the basis of the buckling tables in BS 449.

Effective length

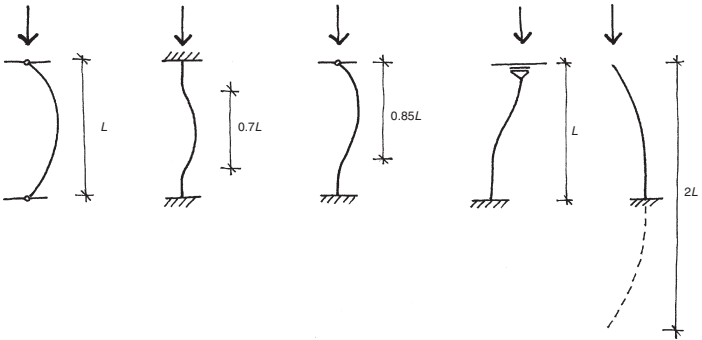

Euler

Euler critical buckling load: $P_E = \frac{\pi^2 EI}{L_e^2}$

Euler critical buckling stress: $\sigma_e = \frac{P_E}{A} = \frac{\pi^2 E r_y^2}{L_e^2} = E \left(\frac{\pi r_y}{L_e} \right)^2$

r_y and l are both for the weaker axis or for the direction of the effective length L_e under consideration.

Perry–Robertson

Perry–Robertson buckling load:

$$P_{PR} = A \left[\frac{(\sigma_c + \sigma_e(K + 1))}{2} - \sqrt{\left(\frac{\sigma_c + \sigma_e(K + 1)}{2} \right)^2 - \sigma_c \sigma_e} \right]$$

$$\text{where } K = 0.3 \left(\frac{L_e}{100r_y} \right)^2$$

σ_e is the Euler critical stress as calculated above and σ_c is the yield stress in compression.

Pinned strut with uniformly distributed lateral load

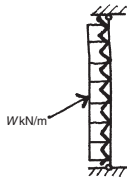

Maximum bending moment, where $\alpha = \sqrt{\frac{P}{EI}}$

$$M_{\max} = \frac{wEI}{P} \left(\sec\left(\frac{\alpha L}{2}\right) - 1 \right)$$

Maximum compressive stress $\sigma_{c \max} = \frac{My}{I} + \frac{P}{A}$

Maximum deflection $\delta_{\max} = \frac{-M}{P} + \frac{wL^2}{8P}$

Rigid frames under lateral loads

Rigid or plane frames are generally statically indeterminate. A simplified method of analysis can be used to estimate the effects of lateral load on a rigid frame based on its deflected shape, and assumptions about the load, shared between the columns. The method assumes notional pinned joints at expected points of contraflexure, so that the equilibrium system of forces can be established by statics. The vertical frame reactions as a result of the lateral loads are calculated by taking moments about the centre of the frame.

The following methods deal with lateral loads on frames, but similar assumptions can be made for vertical analysis (such as treating beams as simply supported) so that horizontal and vertical moments and forces can be superimposed for use in the sizing and design of members.

Rigid frame with infinitely stiff beam

It is assumed that the stiffness of the top beam will spread the lateral load evenly between the columns. From the expected deflected shape, it can be reasonably assumed that each column will carry the same load. Once the column reactions have been assumed, the moments at the head of the columns can be calculated by multiplying the column height by its horizontal base reaction. As the beam is assumed to be infinitely stiff, it is assumed that the columns do not transfer any moment into the beam.

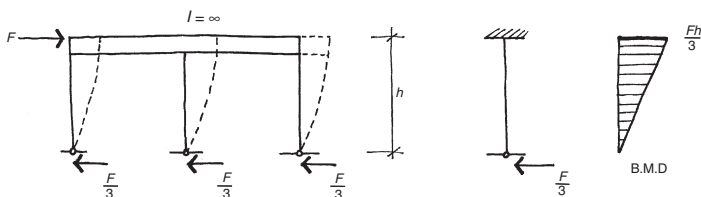

Rigid frame with beams and columns of constant stiffness (EI)

As the top beam is not considerably stiffer than the columns, it will tend to flex and cause a point of contraflexure at mid span, putting extra load on the internal columns. It can be assumed that the internal columns will take twice the load (and therefore moment) of the external columns. As before, the moments at the head of columns can be calculated by multiplying the column height by its horizontal base reaction. The maximum moment in the beam due to horizontal loading of the frame is assumed to equal the moment at the head of the external columns.

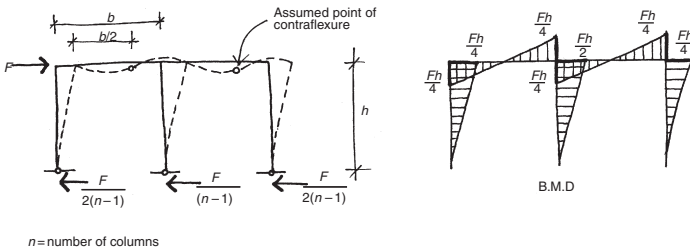

Multi-storey frame with beams and columns of constant stiffness

For a multi-storey frame, points of contraflexure can be assumed at mid points on beams and columns. Each storey is considered in turn as a separate subframe between the column points of contraflexure. The lateral shears are applied to the subframe columns in the same distribution as the single storey frames, so that internal columns carry twice the load of the external columns. As analysis progresses down the building, the total lateral shear applied to the top of each subframe should be the sum of the lateral loads applied above the notional point of contraflexure. The shears are combined with the lateral load applied to the subframe, to calculate lateral shear reactions at the bottom of each subframe. The frame moments in the columns due to the applied lateral loads increase towards the bottom of the frame. The maximum moments in the beam due to lateral loading of the frame are assumed to equal the difference between the moments at the external columns.

Multi storey frame – continued

FULL FRAME EXAMPLE

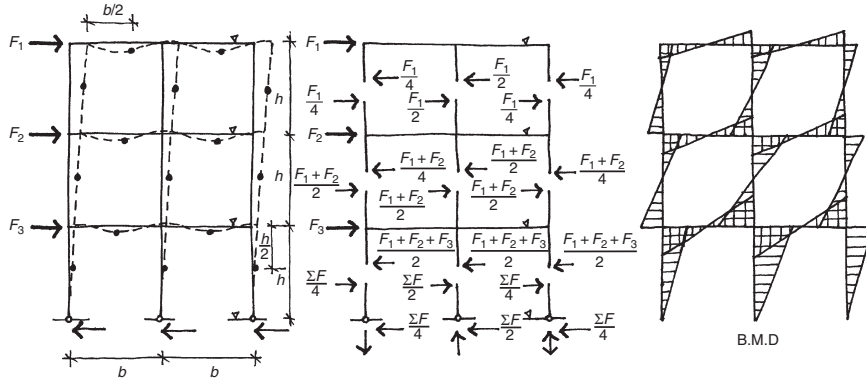

PART FRAME EXAMPLE

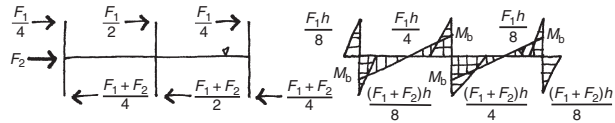

$$\text{where } M_b = \frac{(2F_1 + F_2)h}{8}$$

B.M.D

Plates

Johansen's yield line theory studies the ultimate capacity of plates. Deflection needs to be considered in a separate elastic analysis. Yield line analysis is a powerful tool which should not be applied without background reading and a sound understanding of the theory.

The designer must try to predict a series of failure crack patterns for yield line analysis by numerical or virtual work methods. Crack patterns relate to the expected deflected shape of the slab at collapse. For any one slab problem there may be many potential modes of collapse which are geometrically and statically possible. All of these patterns should be investigated separately. It is possible for the designer to inadvertently omit the worst case pattern for analysis which could mean that the resulting slab might be designed with insufficient strength. Crack patterns can cover whole slabs, wide areas of slabs or local areas, such as failure at column positions or concentrated loads. Yield line moments are typically calculated as kNm/m width of slab.

The theory is most easily applied to isotropic plates which have the same material properties in both directions. An isotropic concrete slab is of constant thickness and has the same reinforcement in both directions. The reinforcement should be detailed to suit the assumptions of yield line analysis. Anisotropic slabs can be analysed if the 'degree of anisotropy' is selected before a standard analysis. As in the analysis of laterally loaded masonry panels, the results of the analysis can be transformed on completion to allow for the anisotropy.

The simplest case to consider is the isotropic rectangular slab:

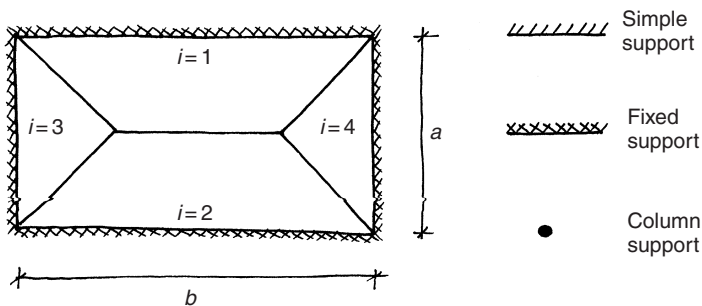

The designer must decide on the amount of fixity, i , at each support position. Generally $i = 0$ for simple support and $i = 1$ for fixed or encastre supports. The amount of fixity determines how much moment is distributed to the top of the slab m' , where $m' = im$ and m is the moment in the bottom of the slab.

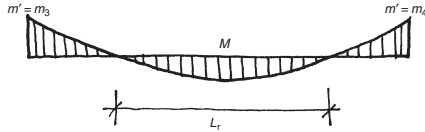

Fixed supports reduce the sagging moments, m , in the bottom of the slab. The distance between the points of zero moment can be considered as a 'reduced effective length', L_r .

$$L_r = \frac{2L}{[\sqrt{(1+i_1)} + \sqrt{(1+i_2)}]} \quad \text{and where } L_r < L : M = \frac{wL_r^2}{8}$$

For the rectangular slab L_r should be calculated for both directions:

$$a_r = \frac{2a}{[\sqrt{(1+i_1)} + \sqrt{(1+i_2)}]} \quad b_r = \frac{2b}{[\sqrt{(1+i_3)} + \sqrt{(1+i_4)}]}$$

So that the design moment is:

$$M = \frac{wa_r b_r}{8 \left(1 + \frac{a_r}{b_r} + \frac{b_r}{a_r} \right)}$$

For fixity on all sides of a square slab (where $a = b = L$) the design moment, $M = wL^2/24$ kNm/m.

For a point load or column support, $M = P/2\pi$ kNm/m.

Selected yield line solutions

These patterns are some examples of those which need to be considered for a given slab. Yield line analysis must be done on many different crack patterns to try to establish the worst case failure moment. Both top and bottom steel should be considered by examining different failure patterns with sagging and hogging crack patterns.

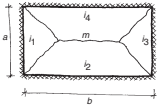

$$a_r = \frac{2a}{\sqrt{1+i_2} + \sqrt{1+i_4}} \quad b_r = \frac{2b}{\sqrt{1+i_1} + \sqrt{1+i_3}}$$

$$m = \frac{w a_r b_r}{8 \left(1 + \frac{a_r}{b_r} + \frac{b_r}{a_r} \right)}$$

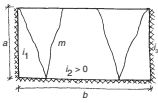

$$b_r = \frac{2b}{\sqrt{1+i_1} + \sqrt{1+i_3}} \quad m = \frac{w a_r b_r}{3 + 12 \frac{a}{b_r} + 2i_2 \left(1 + \frac{b_r}{a} \right)}$$

$$a \leq b_r \quad \text{Top steel also required.}$$

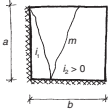

$$b_r = \frac{b}{\sqrt{1+i_1}} \quad m = \frac{w a_r b_r}{\frac{3}{2} + 3 \frac{a}{b_r} + i_2 \left(1 + 2 \frac{b_r}{a} \right)}$$

For opposite case, exchange a and b , i_1 and i_2 .

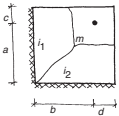

$$F = 0.6 \frac{(a+c)i_1 + (b+d)i_2}{a+b+c+d} \quad m_0 = \frac{3wab}{8 \left(2 + \frac{a}{b} + \frac{b}{a} \right)}$$

$$m = \frac{m_0 - 0.15wcd}{1+F} \quad a \leq b \leq 2a$$

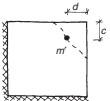

$$m' = \frac{w}{6} (c^2 + d^2)$$

Bottom steel required for main span.

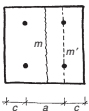

$$\text{if } c = 0.35a, m = m' = \frac{wa^2}{16}$$

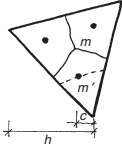

$$m = \frac{wh^2}{3} \left(0.39 - \frac{c}{h} \right), \quad m' = \frac{wc^2}{6}$$

$$\text{If } c = 0.33h, \quad m = m' = \frac{wa^2}{55}$$

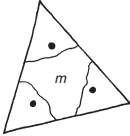

$$m = \frac{wh^2}{2} \left(0.33 - \left(\frac{c}{2h} \right)^{\frac{2}{3}} \right)$$

Torsion

Elastic torsion of circular sections: $\frac{T}{J} = \frac{\tau}{r} = \frac{G\phi}{L}$

Where, T is the applied torque, J is the polar moment of inertia, τ is the torsional shear stress, r is the radius, ϕ is the angle of twist, G is the shear modulus of elasticity and L is the length of member.

The shear strain, γ , is constant over the length of the member and $r\phi$ gives the displacement of any point along the member. Materials yield under torsion in a similar way to bending. The material has a stress/strain curve with gradient G up to a limiting shear stress, beyond which the gradient is zero.

The torsional stiffness of a member relies on the ability of the shear stresses to flow in a loop within the section shape which will greatly affect the polar moment of area, which is calculated from the relationship $J = \int r^2 dA$. This can be simplified in some closed loop cases to $J = I_{zz} = I_{xx} + I_{yy}$.

Therefore for a solid circular section, $J = \pi d^4/32$ for a solid square bar, $J = 5d^4/36$ and for thin walled circular tubes, $J = \pi(d_{\text{outer}}^4 - r_{\text{inner}}^4)/32$ or $J = 2\pi r^3 t$ and the shear stress, $\tau = T/At$ where t is the wall thickness and A is the area contained within the tube.

Thin walled sections of arbitrary and open cross sections have less torsional stiffness than solid sections or tubular thin walled sections which allow shear to flow around the section. In thin walled sections the shear flow is only able to develop within the thickness of the walls and so the torsional stiffness comes from the sum of the stiffness of its parts: $J = \frac{1}{3} \int_{\text{section}} t^3 ds$. This can be simplified to $J \cong \sum (bt^3/3)$, where $\tau = Tt/J$.

J for thick open sections are beyond the scope of this book, and must be calculated empirically for the particular dimensions of a section. For non-square and circular shapes, the effect of the warping of cross sections must be considered in addition to the elastic effects set out above.

Taut wires, cables and chains

The cables are assumed to have significant self-weight. Without any externally applied loads, the horizontal component of the tension in the cable is constant and the maximum tension will occur where the vertical component of the tension reaches a maximum. The following equations are relevant where there are small deflections relative to the cable length.

L	Span length
h	Cable sag
A	Area of cable
ΔL_s	Cable elongation due to axial stress
C	Length of cable curve
E	Modulus of elasticity of the cable
$s = h/L$	Sag ratio
w	Applied load per unit length
V	Vertical reaction
y	Equation for the deflected shape
D	Height of elevation
H	Horizontal reaction
T_{\max}	Maximum tension in cable
x	Distance along cable

Uniformly loaded cables with horizontal chords

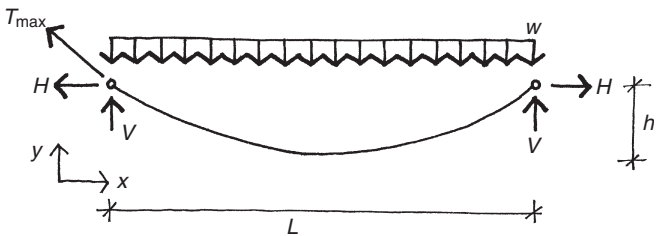

$$y = \frac{4h(Lx - x^3)}{L^2}$$

$$H = \frac{wL^2}{8h}$$

$$V = \frac{wL}{2}$$

$$T_{\max} = H\sqrt{1 + 16s^2}$$

$$C \cong L \left(1 + \frac{8}{3}s^2 - \frac{32}{5}s^4 + \dots \right) \quad \Delta L_s \cong \frac{HL \left(1 + \frac{16s}{3} \right)}{AE}$$

Uniformly loaded cables with inclined chords

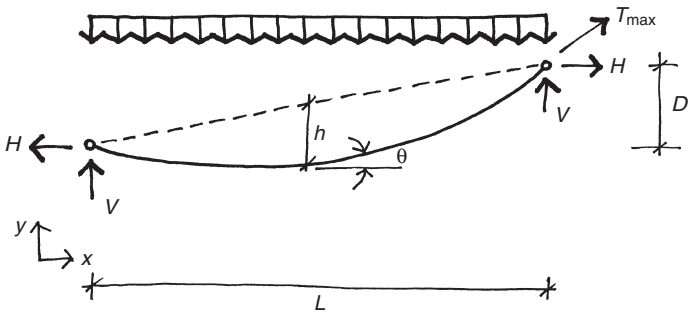

$$y = \frac{4h(Lx - x^2)}{L^2}$$

$$H = \frac{wL^2}{8h}$$

$$V = \frac{HD}{L} + \frac{wL}{2}$$

$$T_{\max} = H\sqrt{1 + \left(\frac{D}{L} + 4s\right)^2}$$

$$C \cong L \sec \theta \left(1 + \frac{8s^2}{3 \sec^4 \theta}\right)$$



$$\Delta L_s \cong \frac{HL \left(1 + \frac{16s}{3 \sec^4 \theta}\right)}{AE}$$

Vibration

When using long spans and lightweight construction, vibration can become an important issue. Human sensitivity to vibration has been shown to depend on frequency, amplitude and damping. Vibrations can detract from the use of the structure or can compromise the structural strength and stability.

Vibrations can be caused by wind, plant, people, adjacent building works, traffic, earthquakes or wave action. Structures will respond differently depending on their mass and stiffness. Damping is the name given to the ability of the structure to dissipate the energy of the vibrations – usually by friction in structural and non-structural components. While there are many sources of advice on vibrations in structures, assessment is not straightforward. In simple cases, structures should be designed so that their natural frequency is greater than 4.5 Hz to help prevent the structure from being dynamically excitable. Special cases may require tighter limits.

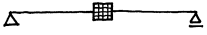
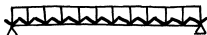
A simplified method of calculating the natural frequency of a structure (f in Hz) is related to the static dead load deflection of the structure, where g is the acceleration due to gravity, δ is the static dead load deflection estimated by normal elastic theory, k is the stiffness ($k = L/EI$), m is the total mass of the system, E is the modulus of elasticity, I is the moment of inertia and L is the length of the member. This method can be used to check the results of more complex analysis.

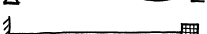
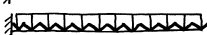
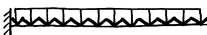
Member		Estimate of natural frequency, α_f
General rule for structures with concentrated mass		$f = \frac{1}{2\pi} \sqrt{\frac{g}{\delta}}$
General rule for most structures with distributed loads		$f = \frac{1}{2\pi} \sqrt{\frac{k}{m}}$
Simplified rule for most structures		$f = \frac{18}{\sqrt{\delta}}$
Simply supported, mass concentrated in the centre		$f = \frac{1}{2\pi} \sqrt{\frac{48EI}{mL^3}}$
Simply supported, sagging, mass and stiffness distributed		$f = \frac{1}{4} \sqrt{\frac{EI}{mL^4}}$
Simply supported, contraflexure, mass and stiffness distributed		$f = \sqrt{\frac{EI}{mL^4}}$
Cantilever, mass concentrated at the end		$f = \frac{1}{2\pi} \sqrt{\frac{3EI}{mL^3}}$
Cantilever, mass and stiffness distributed		$f = \frac{0.56}{2\pi} \sqrt{\frac{EI}{mL^4}}$
Fixed ends, mass and stiffness distributed		$f = \frac{3.57}{2\pi} \sqrt{\frac{EI}{mL^4}}$

For normal floors with span/depth ratios of 25 or less, there are unlikely to be any vibration problems. Typically problems are encountered with steel and lightweight floors with spans over about 8 m.

Source: Bolton, A (1978).

5

Geotechnics

Geotechnics is the engineering theory of soils, foundations and retaining walls. This chapter is intended as a guide which can be used alongside information obtained from local building control officers, for feasibility purposes and for the assessment of site investigation results. Scheme design should be carried out on the basis of a full site investigation designed specifically for the site and structure under consideration.

The relevant codes of practice are:

- BS 5930 for Site Investigation.
- BS 8004 for Foundation Design and BS 8002 for Retaining Wall Design.
- Eurocode 7 for Geotechnical Design.

The following issues should be considered for all geotechnical problems:

- UK (and most international codes) use unfactored loads, while Eurocodes use factored loads.
- All values in this chapter are based on unfactored loads.
- Engineers not familiar with site investigation tests and their implications, soil theory and bearing capacity equations should not use the information in this chapter without using the sources listed in 'Further Reading' for information on theory and definitions.
- The foundation information included in this chapter allows for simplified or idealized soil conditions. In practice, soil layers and variability should be allowed for in the foundation design.
- All foundations must have an adequate factor of safety (normally $\gamma_f = 2$ to 3) applied to the ultimate bearing capacity to provide the allowable bearing pressure for design purposes.
- Settlement normally controls the design and allowable bearing pressures typically limit settlement to 25 mm. Differential settlements should be considered. Cyclic or dynamic loading can cause higher settlements to occur and therefore require higher factors of safety.
- Foundations in fine grained soils (such as clay, silt and chalk) need to be taken down to a depth below which they will not be affected by seasonal changes in the moisture content of the soil, frost action and the action of tree roots. Frost action is normally assumed to be negligible from 450 mm below ground level. Guidelines on trees and shallow foundations in fine grained soils are covered later in the chapter.
- Ground water control is key to the success of ground and foundation works and its effects must be considered, both during and after construction. Dealing with water within a site may reduce the water table of surrounding areas and affect adjoining structures.
- It is nearly always cheaper to design wide shallow foundations to a uniform and predetermined depth, than to excavate narrow foundations to a depth which might be variable on site.

Selection of foundations and retaining walls

The likely foundation arrangement for a structure needs to be considered so that an appropriate site investigation can be specified, but the final foundation arrangement will normally only be decided after the site investigation results have been returned.

Foundations for idealized structure and soil conditions

Foundations must always follow the building type – i.e. a large-scale building needs large-scale/deep foundations. Pad and strip foundations cannot practically be taken beyond 3 m depth and these are grouped with rafts in the classification ‘shallow foundations’, while piles are called deep foundations. They can have diameters from 75 mm to 2000 mm and be 5 m to 100 m in length. The smaller diameters and lengths tend to be bored cast in-situ piles, while larger diameters and lengths are driven steel piles.

Idealized extremes of structure type	Idealized soil conditions				
	Firm, uniform soil in an infinitely thick stratum	Firm stratum of soil overlying an infinitely thick stratum of soft soil	Soft, uniform soil in an infinitely thick stratum	High water table and/or made ground	Soft stratum of soil overlying an infinitely thick stratum of firm soil or rock
Light, flexible structure	Pad or strip footings	Pad or strip footings	Friction piles or surface raft	Piles or surface raft	Bearing piles or piers
Heavy rigid structure	Pad or strip footings	Buoyant raft or friction piles	Buoyant raft or friction piles	Buoyant raft or piles	Bearing piles or piers

Retaining walls for idealized site and soil conditions

Idealized site conditions	Idealized soil types		
	Dry sand and gravel	Saturated sand and gravel	Clay and silt
Working space* available	<ul style="list-style-type: none"> ● Gravity or cantilever retaining wall ● Reinforced soil, gabion or crib wall 	<ul style="list-style-type: none"> ● Dewatering during construction of gravity or cantilever retaining wall 	<ul style="list-style-type: none"> ● Gravity or cantilever retaining wall
Limited working space	<ul style="list-style-type: none"> ● King post or sheet pile as temporary support ● Contiguous piled wall ● Diaphragm wall ● Soil nailing 	<ul style="list-style-type: none"> ● Sheet pile and dewatering ● Secant bored piled wall ● Diaphragm wall 	<ul style="list-style-type: none"> ● King post or sheet pile as temporary support ● Contiguous piled wall ● Soil nailing ● Diaphragm wall
Limited working space and special controls on ground movements	<ul style="list-style-type: none"> ● Contiguous piled wall ● Diaphragm wall 	<ul style="list-style-type: none"> ● Secant bored piled wall ● Diaphragm wall 	<ul style="list-style-type: none"> ● Contiguous piled wall ● Diaphragm wall

*Working space available to allow the ground to be battered back during wall construction.

Site investigation

In order to decide on the appropriate form of site investigation, the engineer must have established the position of the structure on the site, the size and form of the structure, and the likely foundation loads.

BS 5390: Part 2 suggests that the investigation is taken to a depth of 1.5 times the width of the loaded area for shallow foundations. A loaded area can be defined as the width of an individual footing area, the width of a raft foundation, or the width of the building (if the foundation spacing is less than three times the foundation breadth). An investigation must be conducted to prove bedrock must be taken down 3 m beyond the top of the bedrock to ensure that rock layer is sufficiently thick.

Summary of typical site investigation requirements for idealized soil types

Soil type	Type of geotechnical work		
	Excavations	Shallow footings and rafts	Deep foundations and piles
Sand	<ul style="list-style-type: none"> Permeability for dewatering and stability of excavation bottom Shear strength for loads on retaining structures and stability of excavation bottom 	<ul style="list-style-type: none"> Shear strength for bearing capacity calculations Site loading tests for assessment of settlements 	<ul style="list-style-type: none"> Test pile for assessment of allowable bearing capacity and settlements Deep boreholes to probe zone of influence of piles
Clay	<ul style="list-style-type: none"> Shear strength for loads on retaining structure and stability of excavation bottom Sensitivity testing to assess strength and stability and the possibility of reusing material as backfill 	<ul style="list-style-type: none"> Shear strength for bearing capacity calculations Consolidation tests for assessment of settlements Moisture content and plasticity tests to predict heave potential and effects of trees 	<ul style="list-style-type: none"> Long-term test pile for assessment of allowable bearing capacity and settlements Shear strength and sensitivity testing to assess bearing capacity and settlements Deep boreholes to probe zone of influence of piles

Soil classification

Soil classification is based on the sizes of particles in the soil as divided by the British Standard sieves.

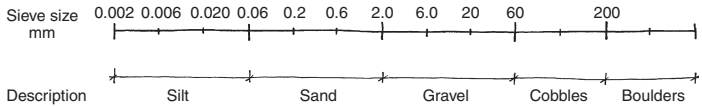

Soil description by particle size

As soils are not normally uniform, standard descriptions for mixed soils have been defined by BS 5930. The basic components are boulders, cobbles, gravel, sand, silt and clay and these are written in capital letters where they are the main component of the soil. Typically soil descriptions are as follows:

Slightly sandy GRAVEL	up to 5% sand	Sandy GRAVEL	5%–20% sand
Very sandy GRAVEL	20%–50% sand	GRAVEL/SAND	equal proportions
Very gravelly SAND	20%–50% gravel	Slightly gravelly SAND	up to 5% gravel
Slightly silty SAND (or GRAVEL)	up to 5% silt	Silty SAND (or GRAVEL)	5%–15% silt
Very silty SAND (or GRAVEL)	15%–35% silt	Slightly clayey SAND (or GRAVEL)	up to 5% clay
Clayey SAND (or GRAVEL)	5%–15% clay	Very clayey SAND (or GRAVEL)	15%–35% clay
Sandy SILT (or CLAY)	35%–65% sand	Gravelly SILT (or CLAY)	35%–65% gravel
Very coarse	over 50% cobbles and boulders		

Soil description by consistency

Homogeneous	A deposit consisting of one soil type.
Heterogeneous	A deposit containing a mixture of soil types.
Interstratified	A deposit containing alternating layers, bands or lenses of different soil types.
Weathered	Coarse soils may contain weakened particles and/or particles sorted according to their size. Fine soils may crumble or crack into a 'column' type structure.
Fissured clay	Breaks into multifaceted fragments along fissures.
Intact clay	Uniform texture with no fissures.
Fibrous peat	Recognizable plant remains present, which retains some strength.
Amorphous peat	Uniform texture, with no recognizable plant remains.

Typical soil properties

The presence of water is critical to the behaviour of soil and the choice of shear strength parameters (internal angle of shearing resistance, ϕ and cohesion, c) are required for geotechnical design.

If water is present in soil, applied loads are carried in the short term by pore water pressures. For granular soils above the water table, pore water pressures dissipate almost immediately as the water drains away and the loads are effectively carried by the soil structure. However, for fine grained soils, which are not as free draining, pore water pressures take much longer to dissipate. Water and pore water pressures affect the strength and settlement characteristics of soil.

The engineer must distinguish between undrained conditions (short-term loading, where pore water pressures are present and design is carried out for total stresses on the basis of ϕ_u and C_u) and drained conditions (long-term loading, where pore water pressures have dissipated and design is carried out for effective stresses on the basis of ϕ' and c').

Drained conditions, $\phi' > 0$

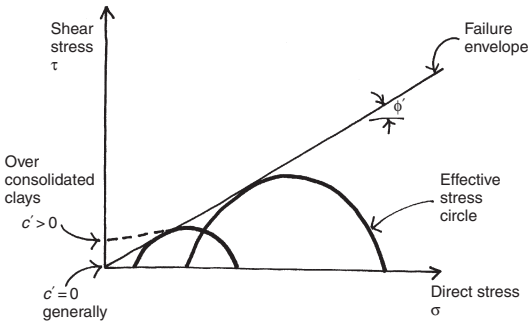

Approximate correlation of properties for drained granular soils

Description	SPT* N blows	Effective internal angle of shearing resistance ϕ'	Bulk unit weight γ_{bulk} kN/m^3	Dry unit weight γ_{dry} kN/m^3
Very loose	0–4	26–28	<16	<14
Loose	4–10	28–30	16–18	14–16
Medium dense	10–30	30–36	18–19	16–17
Dense	30–50	36–42	19–21	17–19
Very dense	>50	42–46	21	19

* An approximate conversion from the standard penetration test to the Dutch cone penetration test: $C_r \approx 400N \text{ kN/m}^2$.

For saturated, dense, fine or silty sands, measured N values should be reduced by: $N = 15 + 0.5(N - 15)$.

Approximate correlation of properties for drained cohesive soils

The cohesive strength of fine grained soils normally increases with depth. Drained shear strength parameters are generally obtained from very slow triaxial tests in the laboratory. The effective internal angle of shearing resistance, ϕ' , is influenced by the range and distribution of fine particles, with lower values being associated with higher plasticity. For a normally consolidated clay the effective (or apparent) cohesion, c' , is zero but for an overconsolidated clay it can be up to 30 kN/m^2 .

Soil description	Typical shrink- ability	Plasticity index PI %	Bulk unit weight γ_{bulk} kN/m^3	Effective internal angle of shearing resistance ϕ'
Clay	High	>35	16–22	18–24
Silty clay	Medium	25–35	16–20	22–26
Sandy clay	Low	10–25	16–20	26–34

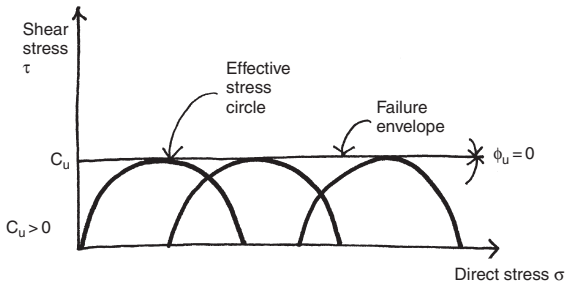
Undrained conditions, $\phi_u = 0$ **Approximate correlation of properties for undrained cohesive soils**

Description	Undrained shear strength C_u kN/m^2	Bulk unit weight γ_{bulk} kN/m^3
Very stiff and hard clays	>150	19–22
Stiff clays	100–150	
Firm to stiff clays	75–100	17–20
Firm clays	50–75	
Soft to firm clays	40–50	
Soft clays and silts	20–40	16–19
Very soft clays and silts	20	

It can be assumed that $C_u \approx 4.5N$ if the clay plasticity index is greater than 30, where N is the number of Standard Penetration Test (SPT) blows.

Typical values of Californian Bearing Ratio (CBR)

Description	CBR
Soft clay	0.5–1
Firm clay	1.5–2
Stiff clay/loose sand	3–5
Compact sand	10–15
Loose gravel	20–25
Compact gravel	40–50

Typical angle of repose for selected soils

The angle of repose is very similar to, and often confused with, the internal angle of shearing resistance. The internal angle of shearing resistance is calculated from laboratory tests and indicates the theoretical internal shear strength of the soil for use in calculations while the angle of repose relates to the expected field behaviour of the soil. The angle of repose indicates the slope which the sides of an excavation in the soil might be expected to stand at. The values given below are for short-term, unweathered conditions.

Soil type	Description	Typical angle of repose	Description	Typical angle of repose
Top soil	Loose and dry	35–40	Loose and saturated	45
Loam	Loose and dry	40–45	Loose and saturated	20–25
Peat	Loose and dry	15	Loose and saturated	45
Clay/Silt	Firm to moderately firm	17–19	Puddle clay	15–19
	Sandy clay	15	Silt	19
	Loose and wet	20–25	Solid naturally moist	40–50
Sand	Compact	35–40	Loose and dry	30–35
	Sandy gravel	35–45	Saturated	25
Gravel	Uniform	35–45	Loose shingle	40
	Sandy compact	40–45	Stiff boulder/hard shale	19–22
	Med coarse and dry	30–45	Med coarse and wet	25–30
Broken rock	Dry	35	Wet	45

Preliminary sizing

Typical allowable bearing pressures under static loads

Description	Safe bearing capacity ¹ kN/m ²	Field description/notes
Igneous rocks and gneisses Limestones and hard sandstones Schists and slates Shales and mudstones Hard block chalk	5000 up to 3000 up to 2000 up to 1000 up to 600	Footings on unweathered rock Beware of sink holes and hollowing as a result of water flow
Very stiff and hard clays	300–600	Requires pneumatic spade for excavation but can be indented by the thumbnail
Stiff clays	150–300	Hand pick – cannot be moulded in hand but can be indented by the thumb
Firm clays	75–150	Can be moulded with firm finger pressure
Soft clays and silts	<75	Easily moulded with firm finger pressure
Very soft clays and silts	nil	Extrudes between fingers when squeezed
Compact gravel and sandy gravel ²	600	Requires pneumatic tools for excavation
Medium dense gravel and sandy gravel ²	200–600	Hand pick – resistance to shovelling
Loose gravel and sandy gravel ²	<200	Small resistance to shovelling
Compact sand ²	300+	Hand pick – resistance to shovelling
Medium dense sand ²	100–300	Hand pick – resistance to shovelling
Loose sand ²	<100	Small resistance to shovelling
Firm organic material/medieval fill	20–40	Can be indented by thumbnail. Only suitable for small scale-buildings where settlements may not be critical
Unidentifiable made ground	25–50	Bearing values depend on the likelihood of voids and the compressibility of the made ground
Springy organic material/peats	nil	Very compressible and open structure
Plastic organic material/peats	nil	Can be moulded in the hand and smears the fingers

NOTES:

1. This table should be read in accordance with the limitations of BS 8004.
2. Values for granular soil assume that the footing width, B , is not less than 1 m and that the water table is more than B below the base of the foundation.

Source: BS 8004: 1986.

Quick estimate design methods for shallow foundations

General equation for allowable bearing capacity after Brinch Hansen

Factor of safety against bearing capacity failure, $\gamma_f = 2.0$ to 3.0 , q'_o is the effective overburden pressure, γ is the unit weight of the soil, B is the width of the foundation, c is the cohesion (for the drained or undrained case under consideration) and N_c , N_q and N_γ are shallow bearing capacity factors.

$$\text{Strip footings: } q_{\text{allowable}} = \frac{cN_c + q'_o N_q + 0.5\gamma B N_\gamma}{\gamma_f}$$

$$\text{Pad footings: } q_{\text{allowable}} = \frac{1.3cN_c + q'_o N_q + 0.4\gamma B N_\gamma}{\gamma_f}$$

Approximate values for the bearing capacity factors N_c , N_q and N_γ are set out below in relation to ϕ .

Internal angle of shear ϕ	Bearing capacity factors*		
	N_c	N_q	N_γ
0	5.0	1.0	0.0
5	6.5	1.5	0.0
10	8.5	2.5	0.0
15	11.0	4.0	1.4
20	15.5	6.5	3.5
25	21.0	10.5	8.0
30	30.0	18.5	17.0
35	45.0	34.0	40.0
40	75.0	65.0	98.0

* Values from charts by Brinch Hansen (1961).

Simplified equations for allowable bearing capacity after Brinch Hansen

For very preliminary design, Terzaghi's equation can be simplified for uniform soil in thick layers.

Spread footing on clay

$$q_{\text{allowable}} = 2C_u \quad \text{Spread footing on undrained cohesive soil } (\gamma_f = 2.5)$$

Spread footing on gravel

$$q_{\text{allowable}} = 10N$$

$$\text{Pad footing on dry soil } (\gamma_f = 3)$$

$$q_{\text{allowable}} = 7N$$

$$\text{Strip footing on dry soil } (\gamma_f = 3)$$

$$q_{\text{wet allowable}} = q_{\text{allowable}}/2$$

$$\text{Spread foundation at or below the water table}$$

Quick estimate design methods for deep foundations

Concrete and steel pile capacities

Concrete piles can be cast in situ or precast, prestressed or reinforced. Steel piles are used where long or lightweight piles are required. Sections can be butt welded together and excess can be cut away. Steel piles have good resistance to lateral forces, bending and impact, but they can be expensive and need corrosion protection.

Typical maximum allowable pile capacities can be 300 to 1800 kN for bored piles (diameter 300 to 600 mm), 500 to 2000 kN for driven piles (275 to 400 mm square precast or 275 to 2000 mm diameter steel), 300 to 1500 kN for continuous flight auger (CFA) piles (diameter 300 to 600 mm) and 50 to 500 kN for mini piles (diameter 75 to 280 mm and length up to 20 m). The minimum pile spacing achievable is normally about three diameters between the pile faces.

Working pile loads for CFA piles in granular soil ($N=15$)

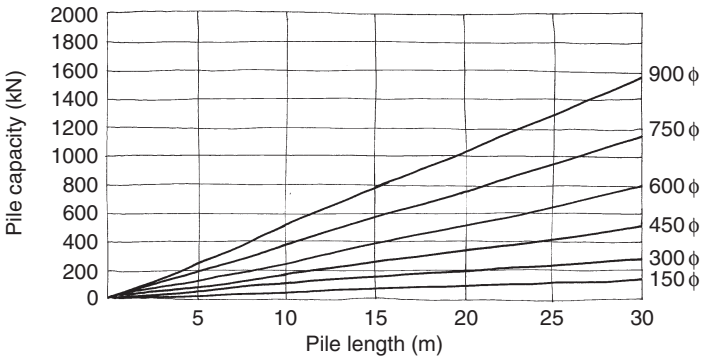

Working pile loads for CFA piles in granular soil ($N=25$)

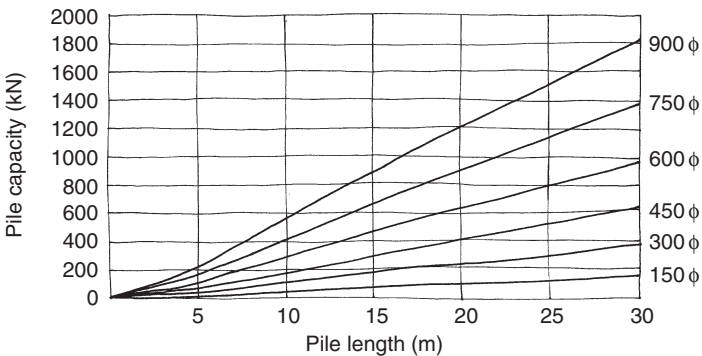

Working pile loads for CFA piles in cohesive soil ($C_u = 50$)

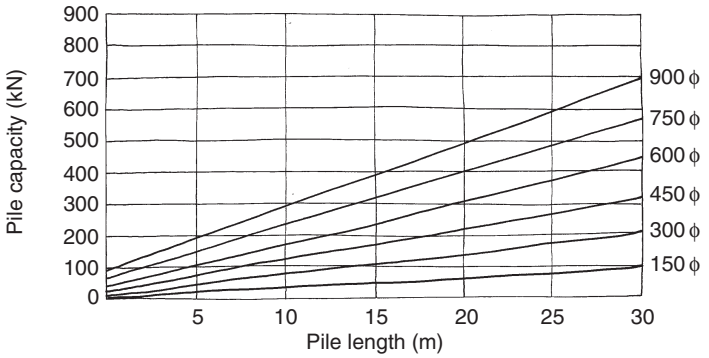

Working pile loads for CFA piles in cohesive soil ($C_u = 100$)

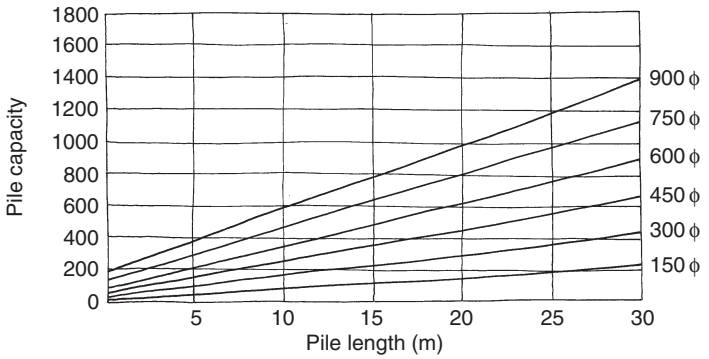

Single bored piles in clay

$$Q_{\text{allow}} = \frac{N_c A_b c_{\text{base}}}{\gamma_{\text{f base}}} + \frac{\alpha \bar{c} A_s}{\gamma_{\text{f shaft}}}$$

Where A_b is the area of the pile base, A_s is the surface area of the pile shaft in the clay, \bar{c} is the average value of shear strength over the pile length and is derived from undrained triaxial tests, where $\alpha = 0.3$ to 0.6 depending on the time that the pile boring is left open. Typically $\alpha = 0.3$ for heavily fissured clay and $\alpha = 0.45$ – 0.5 for firm to stiff clays (e.g. London clay). $N_c = 9$ where the embedment of the tip of the pile into the clay is more than five diameters. The factors of safety are generally taken as 2.5 for the base and 3.0 for the shaft.

Group action of bored piles in clay

The capacity of groups of piles can be as little as 25 per cent of the collective capacity of the individual piles.

A quick estimate of group efficiency:

$$E = 1 - \left(\tan^{-1} \frac{D}{S} \right) \frac{[m(n-1) + n(m-1)]}{90mn}$$

Where D is the pile diameter, S is the pile spacing and m and n represent the number of rows in two directions of the pile group.

Negative skin friction

Negative skin friction occurs when piles have been installed through a compressible material to reach firm strata. Cohesion in the soft soil will tend to drag down on the piles as the soft layer consolidates and compresses causing an additional load on the pile. This additional load is due to the weight of the soil surrounding the pile. For a group of piles a simplified method of assessing the additional load per pile can be based on the volume of soil which would need to be supported on the pile group. $Q_{\text{skin friction}} = AH\gamma/N_p$ where A is the area of the pile group, H is the thickness of the layer of consolidating soil or fill which has a bulk density of γ , and N_p is the number of piles in the group. The chosen area of the pile group will depend on the arrangement of the piles and could be the area of the building or part of the building. This calculation can be applied to individual piles, although it can be difficult to assess how much soil could be considered to contribute to the negative skin friction forces.

Piles in granular soil

Although most methods of determining driven pile capacities require information on the resistance of the pile during driving, capacities for both driven and bored piles can be estimated by the same equation. The skin friction and end bearing capacity of bored piles will be considerably less than driven piles in the same soil as a result of loosening caused by the boring and design values of γ , N and $k_s \tan \delta$ should be selected for loose conditions.

$$Q_{\text{allow}} = \frac{N_q^* A_b q'_o + A_s q'_{o \text{ mean}} k_s \tan \delta}{\gamma_f}$$

Where N_q^* is the pile bearing capacity factor based on the work of Berezantsev, A_b is the area of the pile base, A_s is the surface area of the pile shaft in the soil, q'_o is the effective overburden pressure, k_s is the horizontal coefficient of earth pressure, k_o is the coefficient of earth pressure at rest, δ is the angle of friction between the soil and the pile face, ϕ' is the effective internal angle of shearing resistance and the factor of safety, $\gamma_f = 2.5$ to 3.

Typical values of N_q^*	Pile length Pile diameter		
	5	20	
ϕ			
25	16	11	7
30	29	24	20
35	69	53	45
40	175	148	130

* Berezantsev (1961) values from charts for N_q based on ϕ calculated from uncorrected N values.

Typical values of δ and k_s for sandy soils can therefore be determined based on work by Kulhawy (1984) as follows:

Pile face/soil type	Angle of pile/soil friction δ/ϕ
Smooth (coated) steel/sand	0.5–0.9
Rough (corrugated) steel/sand	0.7–0.9
Cast in place concrete/sand	1.0
Precast concrete/sand	0.8–1.0
Timber/sand	0.8–0.9

Installation and pile type	Coefficients of horizontal soil stress/earth pressure at rest k_s/k_o
Driven piles large displacement	1.00–2.00
Driven piles small displacement	0.75–1.25
Bored cast in place piles	0.70–1.00
Jetted piles	0.50–0.70

Although pile capacities improve with depth, it has been found that at about 20 pile diameters, the skin friction and base resistances stop increasing and 'peak' for granular soils. Generally the peak value for base bearing capacity is 110 000 kN/m² for a pile length of 10 to 20 pile diameters and the peak values for skin friction are 10 kN/m² for loose granular soil, 10 to 25 kN/m² for medium dense granular soil, 25 to 70 kN/m² for dense granular soil and 70 to 110 kN/m² for very dense granular soil.

Source: Kulhawy, F.H (1984). Reproduced by permission of the ASCE.

Pile caps

Pile caps transfer the load from the superstructure into the piles and take up tolerances on the pile position (typically ± 75 mm). The pile cap normally projects 150 mm beyond the pile face and if possible, only one depth of pile cap should be used on a project to minimize cost and labour. The Federation of Piling Specialists suggest the following pile cap thicknesses which generally will mean that the critical design case will be for the sum of all the pile forces to one side of the cap centre line, rather than punching shear:

Pile diameter (mm)	300	350	400	450	500	550	600	750
Pile cap depth (mm)	700	800	900	1000	1100	1200	1400	1600

Retaining walls

Rankine's theory on lateral earth pressure is most commonly used for retaining wall design, but Coulomb's theory is easier to apply for complex loading conditions. The most difficult part of Rankine's theory is the appropriate selection of the coefficient of lateral earth pressure, which depends on whether the wall is able to move. Typically where sufficient movement of a retaining wall is likely and acceptable, 'active' and 'passive' pressures can be assumed, but where movement is unlikely or unacceptable, the earth pressures should be considered 'at rest'. Active pressure will be mobilized if the wall moves 0.25–1 per cent of the wall height, while passive pressure will require movements of 2–4 per cent in dense sand or 10–15 per cent in loose sand. As it is normally difficult to assume that passive pressure will be mobilized, unless it is absolutely necessary for stability (e.g. embedded walls), the restraining effects of passive pressures are often ignored in analysis. The main implications of Rankine's theory are that the engineer must predict the deflected shape, to be able to predict the forces which will be applied to the wall.

Rankine's theory assumes that movement occurs, that the wall has a smooth back, that the retained ground surface is horizontal and that the soil is cohesionless, so that: $\sigma_h = k\sigma_v$

For soil at rest, $k = k_o$, for active pressure, $k = k_a$ and for passive pressure, $k = k_p$.

$$k_o \approx 1 - \sin \phi \quad k_a = \frac{(1 - \sin \phi)}{(1 + \sin \phi)} \quad k_p = \frac{1}{k_a} = \frac{(1 + \sin \phi)}{(1 - \sin \phi)}$$

For cohesive soil, k_o should be factored by the overconsolidation ratio,

$$OCR = \sqrt{\frac{\text{pre-consolidation pressure}}{\text{effective overburden pressure}}}$$

Typical k_o values are 0.35 for dense sand, 0.6 for loose sand, 0.5 to 0.6 for normally consolidated clay and 1.0 to 2.8 for overconsolidated clays such as London clay. The value of k_o depends on the geological history of the soil and should be obtained from a geotechnical engineer.

Rankine's theory can be adapted for cohesive soils, which can shrink away from the wall and reduce active pressures at the top of the wall as a tension 'crack' forms. Theoretically the soil pressures over the height of the tension crack can be omitted from the design, but in practice the crack is likely to fill with water, rehydrate the clay and remobilize the lateral pressure of the soil. The height of crack is $h_c = 2c' / (\gamma \sqrt{k_a})$ for drained conditions and $h_c = 2C_u / \gamma$ for undrained conditions.

Preliminary sizing of retaining walls

Gravity retaining walls – Typically have a base width of about 60–80 per cent of the retained height.

Propped embedded retaining walls – There are 16 methods for the design of these walls depending on whether they are considered flexible (sheet piling) or rigid (concrete diaphragm). A reasonable approach is to use BS 8002 Free Earth Support Method which takes moments about the prop position, followed by the Burland & Potts Method as a check. Any tension crack height is limited to the position of the prop.

Embedded retaining walls – Must be designed for fixed earth support where passive pressures are generated on the rear of the wall, at the toe. An approximate design method is to design the wall with free earth support by the same method as the propped wall but with moments taken at the foot of the embedded wall, before adding 20 per cent extra depth as an estimate of the extra depth required for the fixed earth condition.

Trees and shallow foundations

Trees absorb water from the soil which can cause consolidation and settlements in fine grained soils. Shallow foundations in these conditions may be affected by these settlements and the National House Building Council (NHBC) publish guidelines on the depth of shallow foundations on silt and clay soils to take the foundation to a depth beyond the zone of influence of tree roots. The information reproduced here is current in 2002, but the information may change over time and amendments should be checked with NHBC.

The effect depends on the plasticity index of the soil, the proximity of the tree to the foundation, the mature height of the tree and its water demand. The following suggested minimum foundation depths are based on the assumption that low water demand trees are located 0.2 times the mature height from the building, moderate water demand trees at 0.5 times the mature height and high water demand trees at 1.25 times the mature height of the tree. Where the plasticity index of the soil is not known, assume high plasticity.

Plasticity index, PI = Liquid limit – Plastic limit		Minimum foundation depth with no trees m
Low	10–20%	0.75
Medium	10–40%	0.9
High	>40%	1.0

Source: NHBC (2002). The information may change at any time and revisions should be checked with NHBC.

Water demand and mature height of selected UK trees

The following common British trees are classified as having high, moderate or low water demand. Where the tree cannot be identified, assume high water demand.

Water demand	Broad leaved trees				Conifers		Broad leaf orchard trees	
	Species	Mature height* m	Species	Mature height* m	Species	Mature Height* m	Species	Mature height* m
High	Elm Eucalyptus Oak	18–24 18 16–24	Poplar Willow	25–28 16–24	Cypress	18–20		
Moderate	Acacia false Alder Ash Bay laurel Blackthorn Cherry Hawthorn Honey locust Hornbeam Horse chestnut	18 18 23 10 8 9–17 10 14 17 20	Laburnum Lime Maple Mountain ash Plane Sycamore Tree of heaven Walnut Whitebeam	12 22 8–18 11 26 22 20 18 12	Cedar Douglas fir Pine Spruce Wellingtonia Yew	20 20 20 18 30 12	Apple Cherry Pear Plum	9 15 12 10
Low	Beech Birch Holly	20 14 12	Magnolia Mulberry	9 9				

* For range of heights within species, see the full NHBC source table for full details.

Source: NHBC (2002). The information may change at any time and revisions should be checked with NHBC.

Suggested depths for foundations on cohesive soil

If D is the distance between the tree and the foundation, and H is the mature height of the tree, the following three charts (based on soil shrinkability) will estimate the required foundation depth for different water demand classifications. The full NHBC document allows for a reduction in the foundation depth for climatic reasons, for every 50 miles from the South-East of England.

Suggested depths for foundations on highly shrinkable soil

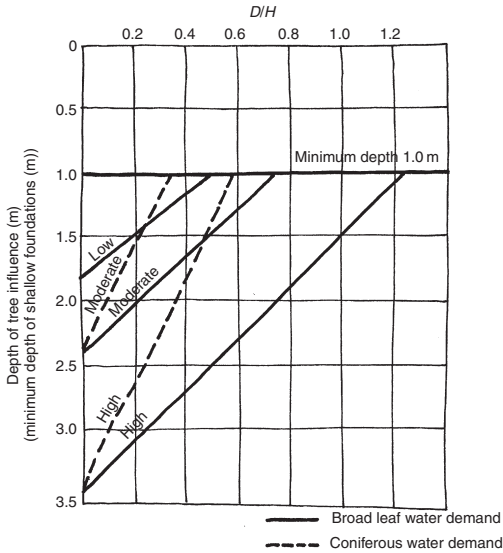

Source: NHBC (2002). The information may change at any time and revisions should be checked with NHBC.

Suggested depths for foundations on medium shrinkable soil

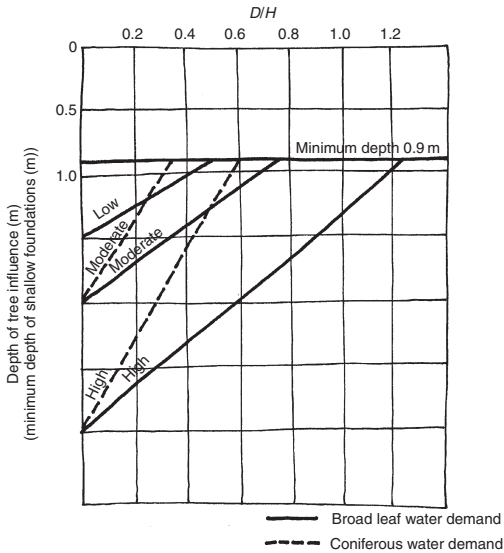

Suggested depths for foundations on low shrinkability soil

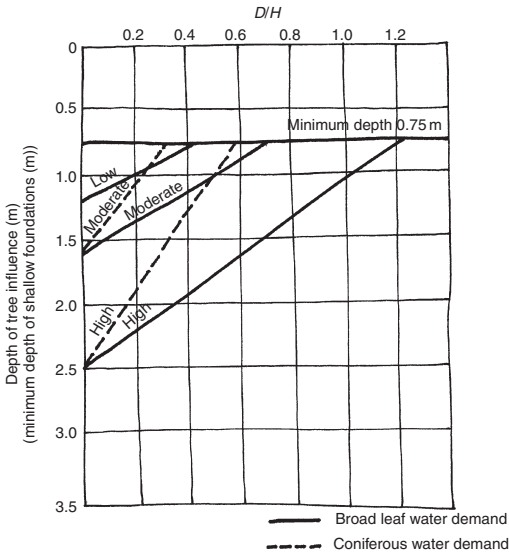

Source: NHBC (2002). The information may change at any time and revisions should be checked with NHBC.

Contaminated land

Contamination can be present as a result of pollution from previous land usage or movement of pollutants from neighbouring sites by air or ground water. The main categories of contamination are chemical, biological (pathological bacteria) and physical (radioactive, flammable materials, etc.).

The Environmental Protection Act 1990 (in particular Part IIA) is the primary legislation covering the identification and remediation of contaminated land. The Act defines contamination as solid, liquid, gas or vapour which might cause harm to 'targets'. This can mean harm to the health of living organisms or property, or other interference with ecological systems. The contamination can be on, in or under the land. The Act applies if the contamination is causing, or will cause, significant harm or results in the pollution of controlled waters including coastal, river and ground water. In order to cause harm the pollution must have some way (called a 'pathway') of reaching the 'target'. The amount of harm which can be caused by contamination will depend on the proposed use for the land. Remediation of contaminated land can remove the contamination, reduce its concentrations below acceptable levels, or remove the 'pathway'.

The 1990 Act set up a scientific framework for assessing the risks to human health from land contamination. This has resulted in Contaminated Land Exposure Assessment (CLEA) and development of Soil Guideline Values for residential, allotment or industrial/commercial land use. Where contaminant concentration levels exceed the Soil Guideline Values, further investigation and/or remediation is required. Reports are planned for a total of 55 contaminants and some are available on the Environment Agency website. Without the full set, assessment is frequently made using Guideline Values from the Netherlands. Other frequently mentioned publications are Kelly and the now superseded ICRC list. Zero Environment has details of the ICRC, Kelly and Dutch lists on its website.

Before developing a 'brownfield site' (i.e. a site which has previously been used) a desk study on the history of the site should be carried out to establish its previous uses and therefore likely contaminants. Sampling should then be used to establish the nature and concentration of any contaminants. Remedial action may be dictated by law, but should be feasible and economical on the basis of the end use of the land.

Common sources of contamination

Specific industries can be associated with particular contaminants and the site history is invaluable in considering which soil tests to specify. The following list is a summary of some of the most common sources of contamination.

Common contaminants	Possible sources of contaminants
'Toxic or heavy metals' (cadmium, lead, arsenic, mercury, etc.)	Metal mines; iron and steelworks; foundries and electroplating
'Safe' metals (copper, nickel, zinc, etc.)	Anodizing and galvanizing; engineering/ship/scrap yards
Combustible materials such as coal and coke dust	Gas works; railways; power stations; landfill sites
Sulphides, chlorides, acids and alkalis	Made-up ground
Oily or tarry deposits and phenols	Chemical refineries; chemical plants; tar works
Asbestos	Twentieth century buildings

Effects of contaminants

Effect of contaminant	Typical contaminants
Toxic/narcotic gases and vapours	Carbon monoxide or dioxide, hydrogen sulphide, hydrogen cyanide, toluene, benzene
Flammable and explosive gases	Acetylene, butane, hydrogen sulphide, hydrogen, methane, petroleum hydrocarbons
Flammable liquids and solids	Fuel oils, solvents; process feedstocks, intermediates and products
Combustible materials	Coal residues, ash timber, variety of domestic commercial and industrial wastes
Possible self-igniting materials	Paper, grain, sawdust – microbial degradation of large volumes if sufficiently damp
Corrosive substances	Acids and alkalis; reactive feedstocks, intermediates and products
Zootoxic metals and their salts	Cadmium, lead, mercury, arsenic, beryllium and copper
Other zootoxic metals	Pesticides, herbicides
Carcinogenic substances	Asbestos, arsenic, benzene, benzo(a)pyrene
Substances resulting in skin damage	Acids, alkalis, phenols, solvents
Phytotoxic metals	Copper, zinc, nickel, boron
Reactive inorganic salts	Sulphate, cyanide, ammonium, sulphide
Pathogenic agents	Anthrax, polio, tetanus, Weils
Radioactive substances	Waste materials from hospitals, mine workings, power stations, etc.
Physically hazardous materials	Glass, blades, hospital wastes – needles etc.
Vermin and associated pests	Rats, mice and cockroaches (contribute to pathogenic agents)

(Where zootoxic means toxic to animals and phytotoxic means toxic to plants.)

Site investigation and sampling

Once a desk study has been carried out and the most likely contaminants are known, an assessment must be carried out to establish the risks associated with the contaminants and the proposed land use. These two factors will determine the maximum concentrations of contaminants which will be acceptable. These maximum concentrations are the Soil Guideline Values published by the Department for the Environment, Food and Rural Affairs (DEFRA) as part of the CLEA range of documents.

Once the soil guideline or trigger values have been selected, laboratory tests can be commissioned to discover if the selected soil contaminants exist, as well as their concentration and their distribution over the site. Reasonably accurate information can be gathered about the site using a first stage of sampling and testing to get a broad picture and a second stage to define the extents of localized areas of contamination.

Sampling on a rectangular grid with cores of 100 mm diameter, it is difficult to assess how many samples might be required to get a representative picture of the site. British Standards propose 25 samples per 10 000 m² which is only 0.002 per cent of the site area. This would only give a 30 per cent confidence of finding a 100 m² area of contamination on the site, while 110 samples would give 99 per cent confidence. It is not easy to balance the cost and complexity of the site investigations and the cost of any potential remedial work, without an appreciation of the extent of the contamination on the site!

Remediation techniques

There are a variety of techniques available depending on the contaminant and target user. The chosen method of treatment will not necessarily remove all of a particular contaminant from a site as in most circumstances it may be sufficient to reduce the risk to below the predetermined trigger level. In some instances it may be possible to change the proposed layout of a building to reduce the risk involved. However, if the site report indicates that the levels of contaminant present in the soil are too high, four main remediation methods are available:

Excavation

Excavation of contaminated soil for specialist disposal or treatment (possibly in a specialist landfill site) and reconstruction of the site with clean fill material. This is expensive and the amount of excavated material can sometimes be reduced, by excavating down to a limited 'cut-off' level, before covering the remaining soil with a barrier and thick granular layer to avoid seepage/upward migration. Removal of soil on restricted sites might affect existing, adjacent structures.

Blending

Clean material is mixed into the bulk of the contaminated land to reduce the overall concentrations taking the test samples below trigger values. This method can be cost effective if some contaminated soil is removed and replaced by clean imported fill, but it is difficult to implement and the effects on adjacent surfaces and structures must be taken into account.

Isolation

Isolation of the proposed development from the contaminants can be attempted by displacement sheet piling, capping, horizontal/vertical barriers, clay barriers, slurry trenches or jet grouting. Techniques should prevent contaminated soil from being brought out of the ground to contaminate other areas.

Physical treatment

Chemical or biological treatment of the soil so that the additives bond with and reduce the toxicity of, or consume, the contaminants.

6

Timber and Plywood

Commercial timbers are defined as hardwoods and softwoods according to their botanical classification rather than their physical strength. Hardwoods are from broad leaved trees which are deciduous in temperate climates. Softwoods are from conifers, which are typically evergreen with needle shaped leaves.

Structural timber is specified by a strength class which combines the timber species and strength grade. Strength grading is the measurement or estimation of the strength of individual timbers, to allow each piece to be used to its maximum efficiency. This can be done visually or by machine. The strength classes referred to in Eurocode 5 and BS 5268 are C14 to C40 for softwoods (C is for coniferous) and D30 to D70 for hardwoods (D is for deciduous). The number refers to the ultimate bending strength in N/mm^2 before application of safety factors for use in design. The Eurocodes use Limit State Design with factored design loads. The British Standards use permissible stresses and grade stresses are modified by load factors according to the design conditions. C16 is the most commonly available softwood, followed by the slightly stronger C24. Specification of C24 should generally be accompanied by checks to confirm that it has actually been used on site in preference to the more readily available C16.

Timber products

Wood-based sheet materials are the main structural timber products, containing substantial amounts of wood in the form of strips, veneers, chips, flakes or fibres. These products are normally classified as:

Laminated panel products – Plywood, laminated veneered lumber (LVL) and glue laminated timber (glulam) for structural use. Made out of laminations 2 to 43 mm thick depending on the product.

Particleboard – Chipboard, orientated strandboard (OSB) and wood-wool. Developed to use forest thinnings and sawmill waste to create cheap panelling for building applications. Limited structural uses.

Fibreboard – Such as hardboard, medium density fibreboard (MDF). Fine particles bonded together with adhesive to form general, non-structural, utility boards.

Summary of material properties

Density 1.2 to 10.7 kN/m³. Softwood is normally assumed to be between 4 and 6 kN/m³.

Moisture content After felling, timber will lose moisture to align itself with atmospheric conditions and becomes harder and stronger as it loses water. In the UK the atmospheric humidity is normally about 14%. Seasoning is the name of the controlled process where moisture content is reduced to a level appropriate for the timber's proposed use. Air seasoning within the UK can achieve a moisture content of 17–23% in several months for softwood, and over a period of years for hardwoods. Kiln drying can be used to achieve the similar moisture contents over several days for softwoods or two to three weeks for hardwoods.

Moisture content should be lower than 20% to stop fungal attack.

Shrinkage Shrinkage occurs as a result of moisture loss. Typical new structural softwood will reduce in depth across the grain by as much as 3–4% once it is installed in a heated environment. Shrinkage should be allowed for in structural details.

BS 5268: Part 2 sets out Service Classes 1, 2 and 3 which define timber as having moisture contents of <12%, <20% and >20% respectively.

Timber section sizes

Selected timber section sizes and section properties

Timber over the standard maximum length, of about 5.5 m, is more expensive and must be pre-ordered.

Basic size*		Area 10 ² mm ²	Z _{xx} 10 ³ mm ³	Z _{yy} 10 ³ mm ³	I _{xx} 10 ⁶ mm ⁴	I _{yy} 10 ⁶ mm ⁴	r _{xx} mm	r _{yy} mm
D mm	B mm							
100	38	38	63.3	24.1	3.17	0.46	28.9	11.0
100	50	50	83.3	41.7	4.17	1.04	28.9	14.4
100	63	63	105.0	66.2	5.25	2.08	28.9	18.2
100	75	75	125.0	93.8	6.25	3.52	28.9	21.7
100	100	100	166.7	166.7	8.33	8.33	28.9	28.9
150	38	57	142.5	36.1	10.69	0.69	43.3	11.0
150	50	75	187.5	62.5	14.06	1.56	43.3	14.4
150	63	94	236.3	99.2	17.72	3.13	43.3	18.2
150	75	112	281.3	140.6	21.09	5.27	43.3	21.7
150	100	150	375.0	250.0	28.13	12.50	43.3	28.9
150	150	225	562.5	562.5	42.19	42.19	43.3	43.3
175	38	66	194.0	42.1	16.97	0.80	50.5	11.0
175	50	87	255.2	72.9	22.33	1.82	50.5	14.4
175	63	110	321.6	115.8	28.14	3.65	50.5	18.2
175	75	131	382.8	164.1	33.50	6.15	50.5	21.7
200	38	76	253.3	48.1	25.33	0.91	57.7	11.0
200	50	100	333.3	83.3	33.33	2.08	57.7	14.4
200	63	126	420.0	132.3	42.00	4.17	57.7	18.2
200	75	150	500.0	187.5	50.00	7.03	57.7	21.7
200	100	200	666.7	333.3	66.67	16.67	57.7	28.9
200	150	300	1000.0	750.0	100.00	56.25	57.7	43.3
200	200	400	1333.3	1333.3	133.33	133.33	57.7	57.7
225	38	85	320.6	54.2	36.07	1.03	65.0	11.0
225	50	112	421.9	93.8	47.46	2.34	65.0	14.4
225	63	141	531.6	148.8	59.80	4.69	65.0	18.2
225	75	168	632.8	210.9	71.19	7.91	65.0	21.7
250	50	125	520.8	104.2	65.10	2.60	72.2	14.4
250	75	187	781.3	234.4	97.66	8.79	72.2	21.7
250	100	250	1041.7	416.7	130.21	20.83	72.2	28.9
250	250	625	2604.2	2604.2	325.52	325.52	72.2	72.2
300	50	150	750.0	125.0	112.50	3.13	86.6	14.4
300	75	225	1125.0	281.3	168.75	10.55	86.6	21.7
300	100	300	1500.0	500.0	225.00	25.00	86.6	28.9
300	150	450	2250.0	1125.0	337.50	84.38	86.6	43.3
300	300	900	4500.0	4500.0	675.00	675.00	86.6	86.6

* Under dry exposure conditions.

Source: BS 5268: Part 2: 1991.

Tolerances on timber cross sections

BS EN 336 sets out the customary sizes of structural timber. Class 1 timbers are 'sawn' and Class 2 timbers are 'planed'. The permitted deviations for tolerance Class 1 are -1 mm to +3 mm for dimensions up to 100 mm and -2 mm to +4 mm for dimensions greater than 100 mm. For Class 2, the tolerance for dimensions up to 100 mm is ±1 mm and ±1.5 mm for dimensions over 100 mm. Structural design to BS 5268 allows for these tolerances and therefore analysis should be carried out for a 'target' section. It is the dimensions of the target section which should be included in specifications and on drawings.

Laminated timber products

Plywood

Plywood consists of veneers bonded together so that adjacent plies have the grain running in orthogonal directions. Plywoods in the UK generally come from America, Canada, Russia, Finland or the Far East, although the Russian and Far East plywood is not listed in BS 5268 and therefore is not proven for structural applications. The type of plywood available is dependent on the import market. It is worthwhile calling around importers and stockists if a large or special supply is required. UK sizes are based on the imperial standard size of $8' \times 4'$ (2.440×1.220 m). The main sources of imported plywood in the UK are:

Canada and America The face veneer generally runs parallel to the longer side. Mainly imported as Douglas fir 18 mm ply used for concrete shuttering, although 9 and 12 mm are also available. Considered a specialist structural product by importers.

Finland The face veneer can be parallel to the short or long side. Frequently spruce, birch or birch faced ply. Birch plies are generally for fair faced applications, while spruce 9, 12, 18 and 24 mm thick is for general building use, such as flooring and roofing.

Glue laminated timber

Timber layers, normally 43 mm thick, are glued together to build up deep beam sections. Long sections can be produced by staggering finger joints in the layers. Standard beam widths vary from 90 mm to 240 mm although widths up to 265 mm and 290 mm are available. Beam heights and lengths are generally limited to 2050 mm and 31 m respectively. Column sections are available with widths of 90–200 mm and depths of 90–420 mm. Tapered and curved sections can also be manufactured. Loads are generally applied at 90° to the thickness of the layers.

Laminated veneered lumber (LVL)

LVL is similar to plywood but is manufactured with 3 mm veneers in a continuous production line to create panels 1.8 m wide, up to 26 m in length. It is quite a new product, with relatively few UK suppliers. Beam sections for long spans normally have all their laminations running longitudinally, while smaller, panel products tend to have about a fifth of the laminations cross bonded to improve lateral bending strength. Finnforest produce Kerto-S LVL for beams and Kerto-Q LVL for panels. Standard sections are as follows:

Depth/width (mm)	Thickness of panel (mm)								
	27	33	39	45	51	57	63	69	75
200	●	●	●	●	●	●	●	●	●
225	●	●	●	●	●	●	●	●	●
260		●	●	●	●	●	●	●	●
300			●	●	●	●	●	●	●
360				●	●	●	●	●	●
400					●	●	●	●	●
450						●	●	●	●
500							●	●	●
600								●	●
Kerto type	S/Q	S/Q	S/Q	S/Q	S/Q	S/Q	S/Q	S/Q	S

Source: Finnforest (2002).

Durability and fire resistance

Durability

Durability of timber depends on its resistance to fungal decay. Softwood is more prone to weathering and fungal attack than hardwood. Some timbers (such as oak, sweet chestnut, western red cedar and Douglas fir) are thought to be acidic and may need to be isolated from materials such as structural steelwork. The durability of timber products (such as plywood, LVL and glulam) normally depends on the stability and water resistance of the glue.

Weathering

On prolonged exposure to sunlight, wind and rain, external timbers gradually lose their natural colours and turn grey. Repeated wetting and drying cycles raise the surface grain, open up surface cracks and increase the risk of fungal attack, but weathering on its own generally causes few structural problems.

Fungal attack

For growth in timber fungi need oxygen, a minimum moisture content of 20% and temperatures between 20°C and 30°C. Kiln drying at temperatures over 40°C will generally kill fungi, but fungal growth can normally be stopped by reducing the moisture content. Where structural damage has occurred, the affected timber should be cut away and replaced by treated timber. The remaining timber can be chemically treated to limit future problems. Two of the most common destructive fungi are:

'Dry rot' – *Serpula lacrimans* Under damp conditions, white cotton wool strands form over the surface of the timber. Under drier conditions, a grey-white layer forms over the timber with occasional patches of yellow or lilac. Fruiting bodies are plate-like forms which disperse red spores. As a result of an attack, the timber becomes dry and friable (hence the name dry rot) and breaks up into cube-like pieces both along and across the grain.

'Wet rot' – *Coniophora puteana* Known as cellar fungus, this fungus is the most common cause of timber decay in the UK. It requires high moisture contents of 40–50% which normally result from leaks or condensation. The decayed timber is dark and cracked along the grain. The thin strands of fungus are brown or black, but the green fruiting bodies are rarely seen in buildings. The decay can be hidden below the timber surface.

Insect attack

Insect attack on timber in the UK is limited to a small number of species and tends to be less serious than fungal attack. The reverse is generally true in hotter climates. Insects do not depend on damp conditions although some species prefer timber which has already suffered from fungal attack. Treatment normally involves removal of timber and treatment with pesticides. Some common insect pests in the UK are:

'Common furniture beetle' – *nobium punctatum* This beetle is the most widespread. It attacks hardwoods and softwoods, and can be responsible for structural damage in severe cases. The brown beetle is 3–5 mm long; leaves flight holes of approximately 2 mm in diameter between May and September, and is thought to be present in up to 20 per cent of all buildings.

'Wood boring weevils' – *Pentarthum huttonii* and *Euophrym confine* Wood boring beetles attack timber previously softened by fungal decay. *Pentarthum huttonii* is the most common of the weevils and produces damage similar in appearance to the common furniture beetle. The beetles are 3–5 mm long and leave 1 mm diameter flight holes.

'Powder post beetle' – *Lyctus brunneus* The powder post beetle attacks hardwoods, particularly oak and ash, until the sapwood is consumed. The extended soaking of vulnerable timbers in water can reduce the risk of attack but this is not normally commercially viable. The 4 mm reddish-brown beetle leaves flight holes of about 1.5 mm diameter.

'Death watch beetle' – *Xestobium rufovillosum* The death watch beetle characteristically attacks partly decayed hardwoods, particularly oak, and is therefore responsible for considerable damage to old or historic buildings. The beetles typically make tapping noises during their mating season between March and June. Damp conditions encourage infestation. The brown beetle is approximately 8 mm long and leaves a flight hole of 3 mm diameter.

'Longhorn beetle' – *Hylotrupes bajulus* The house long horn beetle is a serious pest, mainly present in parts of southern England. The beetle can infest and cause significant structural damage to the sapwood of seasoned softwood. Affected timbers bulge where tunnelling has occurred just below the surface caused by larvae that can be up to 35 mm long. The flight holes of the black beetle are oval and up to 10 mm across.

Source: BRE Digests 299, 307 and 345. Reproduced with permission by Building Research Establishment.

Fire resistance

Timber is an organic material and is therefore combustible. As timber is heated, water is driven off as vapour. By the time it reaches 230–250°C, the timber has started to break down into charcoal, producing carbon monoxide and methane (which cause flaming). The charcoal will continue to smoulder to carbon dioxide and ash. However, despite its combustibility, large sections of timber can perform better in fire than the equivalent sections of exposed steel or aluminium. Timber has a low thermal conductivity which is further protected by the charred surface, preventing the interior of the section from burning.

BS 5268: Part 4 details the predicted rates of charring for different woods which allows them to be 'fire engineered'. Most timbers in BS 5268 have accepted charring rates of 20 mm in 30 minutes and 40 mm in 60 minutes. The exceptions are western red cedar which chars more quickly at 25 mm in 30 minutes and 50 mm in 60 minutes, and oak, utile, teak, jarrah and greenheart which all char slower at 15 mm in 30 minutes and 30 mm in 60 minutes. Linear extrapolation is permitted for periods between 15 and 90 minutes.

Preliminary sizing of timber elements

Typical span/depth ratios for softwoods

Description	Typical depth (mm)
Domestic floor (50 mm wide joists at 400 mm c/c)	L/24 + 25 to 50
Office floors (50 mm wide joists at 400 mm c/c)	L/15
Rafters (50 mm wide joists at 400 mm c/c)	L/24
Beams/purlins	L/10 to 15
Independent posts	Min. 100 mm square
Triangular trusses	L/5 to 8
Rectangular trusses	L/10 to 15
Plywood stressed skin panels	L/30 to 40

Connections which rely on fixings (rather than dead bearing) to transfer the load in and out of the timber can often control member size and for preliminary sizing. Highly stressed individual members should be kept at about 50 per cent capacity until the connections can be designed in detail.

Plywood stress skin panels

Stress skin panels can be factory made using glue and screws or on site just using screws. The screws tend to be at close centres to accommodate the high longitudinal shear stresses. Plywood can be applied to the top, or top and bottom, of the internal softwood joists (webs). The webs are spaced according to the width of the panel and the point loads that the panel will need to carry. The spacing is normally about 600 mm for a UDL of 0.75 kN/m^2 , about 400 mm for a UDL of 1.5 kN/m^2 or about 300 mm for a UDL of more than 1.5 kN/m^2 . The direction of the face grain of the plywood skin will depend on the type of plywood chosen for the panel. The top ply skin will need to be about 9–12 mm thick for a UDL of 0.75 kN/m^2 or about 12–18 mm thick for a UDL of 1.5 kN/m^2 . The bottom skin, if required, is usually 8–9 mm. The panel design is normally controlled by deflection and for economy the EI of the trial section should be about $4.4WL^2$.

Domestic floor joist capacity chart

See the graph below for an indication of the load carrying capacity of various joist sizes in grade C16 timber spaced at 400 mm centres.

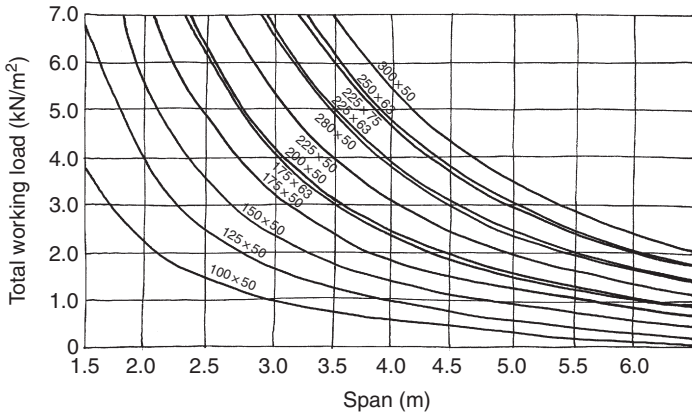

Span tables for solid timber tongued and grooved decking

UDL* kN/m ²	Single span (m) for decking thickness				Double span (m) for decking thickness			
	38 mm	50 mm	63 mm	75 mm	38 mm	50 mm	63 mm	75 mm
1.0	2.2	3.0	3.8	4.7	3.0	3.9	5.2	6.3
1.5	1.9	2.6	3.3	4.0	2.6	3.4	4.5	5.4
2.0	1.7	2.3	3.0	3.6	2.4	3.1	4.0	4.9
2.5	1.6	2.2	2.8	3.4	2.2	2.9	3.7	4.6
3.0	1.5	2.1	2.6	3.2	2.1	2.7	3.5	4.3

* These loads limit the deflection to span/240 as the decking is not normally used with a ceiling.

Timber design to BS 5268

BS 5268: Part 2: 2002 gives guidance on the basis of permissible stresses in the timber. All applied loads for analysis should be unfactored as it is the timber grade stresses which are factored to represent the design conditions being considered.

Notation for BS 5268: Part 2

Symbols	Subscripts		
	Type of force/stress etc.	Significance	Geometry
σ Stress	<i>c</i> Compression	<i>a</i> Applied	\parallel Parallel to the grain
τ Shear stress	<i>m</i> Bending	<i>grade</i> Grade	\perp Perpendicular to the grain
<i>E</i> Modulus of elasticity	<i>t</i> Tension	<i>adm</i> Permissible	α Angle to the grain
<i>i</i> Radius of gyration		<i>mean</i> Arithmetic mean	
		<i>min</i> Minimum	

Source: BS 5268: Part 2: 2002.

Selected timber grade stresses and E for timber in service classes 1 and 2

Strength class	Bending parallel to grain $\sigma_{b }$ N/mm ²	Tension parallel to grain $\sigma_{t }$ N/mm ²	Compression parallel to grain $\sigma_{c }$ N/mm ²	Compression perpendicular to the grain ¹		Shear parallel to the grain $\tau_{ }$ N/mm ²	Modulus of elasticity		Average density ρ kg/m ³
				Mean $\sigma_{c\perp}$ N/mm ²	Minimum $\sigma_{c\perp}$ N/mm ²		Mean E_{mean} N/mm ²	Minimum E_{min} N/mm ²	
C16	5.3	3.2	6.8	2.2	1.7	0.67	8800	5800	370
C24	7.5	4.5	7.9	2.4	1.9	0.71	10 800	7200	420
D40	12.5	7.5	12.6	3.9	3.0	2.00	10 800	7500	700
D50	16.0	9.6	15.2	4.5	3.5	2.20	15 000	12 600	780

NOTES:

1. Wane is where the timber has rounded edges when it has been cut from the edge of the tree, causing the timber section size to be slightly reduced. Where the specification specifically prohibits wane at bearing areas the higher values of compression perpendicular to the grain should be used, otherwise the lower values apply.
2. The moisture contents for service classes are: Class 1 <12%, Class 2 <20% and Class 3 >20%.
3. For Class 3, timber grade stresses need to be reduced by the factors for K_2 given in Table 13 in BS 5268, but normally in wet conditions the type and preservation of the timber must be carefully selected.
4. In the absence of specific data, properties perpendicular to the grain can be assumed as:
Tension perpendicular to the grain, torsional shear and rolling shear = $\tau_{||}/3$
Modulus of elasticity perpendicular to the grain = $E/20$
Shear modulus = $E/16$

Source: BS 5268: Part 2: 2002.

Horizontally glue laminated grade stresses

The following modification factors should be applied to the grade stresses for C24 timber to obtain the equivalent C24 glue laminated (glulam) grade stresses for members built up in 43 mm thick horizontal laminations.

Number of laminations	Bending parallel to grain K_{15}	Tension parallel to grain K_{16}	Compression parallel to grain K_{17}	Compression perpendicular to the grain K_{18}	Shear parallel to the grain K_{19}	Modulus of elasticity K_{20}
4	1.26	1.26	1.04	1.55	2.34	1.07
5	1.34	1.34				
7	1.39	1.39				
10	1.43	1.43				
15	1.48	1.48				
≥20	1.52	1.52				

Source: BS 5268: Part 2: 2002.

Selected plywood properties to BS 5268 for all service classes

BS 5268 lists the properties of many different types of plywood. The properties listed here are extracts from BS 5268 for the plywoods most commonly available from UK timber importers in 2002.

Nominal thickness mm	Number of plies mm	Minimum thickness mm	Section properties for 1 m plywood width			Approximate weight kN/m ²
			Area cm ²	Z cm ³	I cm ⁴	
American construction and industrial plywood: unsanded						
9.5	3	8.7	87	12.6	5.49	0.054
12.5	4 & 5	11.9	119	23.6	14.04	0.073
18.0	4 & 5	17.5	175	51.0	44.66	0.108
Canadian Douglas fir and softwood plywood: sanded						
9.5	3	9.0	90	13.5	6.08	0.044
12.5	4 & 5	12.0	120	24.0	14.40	0.058
18.5	5, 6 & 7	18.0	180	54.0	48.60	0.085
Finnish birch-faced plywood: sanded						
9.0	7	8.8	88	12.9	5.68	0.062
12.0	7 & 9	11.5	115	22.0	12.70	0.081
18.0	11 & 13	17.1	171	48.7	41.70	0.116
24	13, 15 & 17	22.9	229	87.4	100.10	0.152
Finnish conifer plywood: sanded						
9.0	3, 5 & 7	8.6	86	12.3	5.30	0.053
12.0	4, 5, 7 & 9	11.5	115	22.0	12.50	0.066
18.0	6, 7, 9, 11 & 13	17.1	171	48.7	41.70	0.098
24.0	8, 9, 11, 13 & 17	28.1	281	132.0	184.80	0.158

Selected LVL grade stresses for service classes 1 and 2

Strength class	Bending parallel to grain $\sigma_{b }$ N/mm ²	Tension parallel to grain $\sigma_{t }$ N/mm ²	Compression parallel to grain $\sigma_{c }$ N/mm ²	Compression perpendicular to grain		Shear parallel to grain		Modulus of elasticity
				Edge	Flat	Edge	Flat	
				$\sigma_{c\perp}$ N/mm ²	$\sigma_{c\perp}$ N/mm ²	$\tau_{ }$ N/mm ²	$\tau_{ }$ N/mm ²	E_{min} N/mm ²
Kerto S	17.5	12.1	14.8	2.9	1.4	2.0	1.5	11 500
Kerto Q	13.2	8.9	11.1	1.5	1.4	2.3	0.6	8360

Note: The average LVL density is about 510 kg/m³.

Sources: BS 5268: Part 2: 2002 Finnforest (2002).

Slenderness – maximum depth to breadth ratios

Degree of lateral support	Maximum d/b
No lateral support	2
Ends held in position	3
Ends held in position and members held in line as by purlins or tie rods at centres $<30b$	4
Ends held in position and compression edge held in line as by direct connection of sheathing, deck or joists	5
Ends held in position and compression edge held in line as by direct connection of sheathing, deck or joists together with adequate blocking spaced at centres $<6d$	6
Ends held in position and both edges held firmly in line	7

Modification factors

Duration of load K_3 factor

Duration of loading	K_3
Long term (dead + permanent imposed ¹) – Normally includes all live loads except for corridors, hallways and stairs, where the live load can sometimes be considered short term	1.00
Medium term (dead + snow, dead + temporary imposed)	1.25
Short term (dead + imposed + wind ² , dead + imposed + snow + wind ²)	1.50
Very short term (dead + imposed + snow + wind ³)	1.75

NOTES:

- For C3 imposed load occupancy to BS 6399, $K_3 = 1.5$ for UDL loads on corridors, hallways, landings and stairs.
- Short-term wind applies to either a 15 second gust, or where the largest diagonal dimension of the element $>50m$.
- Very short-term wind applies to either a 5 second gust, or where the largest diagonal dimension of the element $<50m$.

Source: BS 5268: Part 2: 2002.

Depth factor for flexural members K_7 or width factor for tension members K_{14}

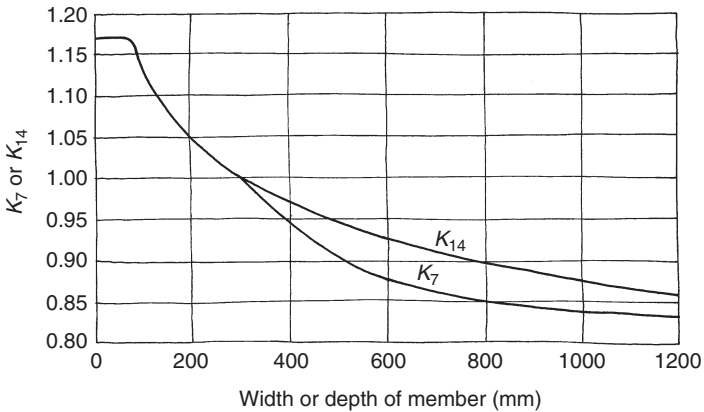

Load-sharing system factor K_8

Where a structural arrangement consists of four or more members such as rafters, joists, trusses or wall studs spaced at a maximum of 610 mm, $K_8 = 1.1$ may be used to increase the grade stresses. K_8 can also be applied to trimmer joists and lintels consisting of two or more timber elements connected in parallel.

Effective length of compression members

End conditions	L_e/L
Restrained at both ends in position and in direction	0.7
Restrained at both ends in position and one end in direction	0.85
Restrained at both ends in position but not in direction	1.0
Restrained at one end in position and in direction and at the other end in direction but not in position	1.5
Restrained at one end in position and direction and free at the other end.	2.0

Generally the slenderness should be less than 180 for members carrying compression, or less than 250 where compression would only occur as a result of load reversal due to wind loading.

Compression buckling factor K_{12}

The stress in compression members should be less than the grade stress for compression parallel to the grain modified for service class, load sharing, duration of load and K_{12} for slenderness. The following graph of K_{12} has been calculated on the basis of E_{\min} and $\sigma_{c||}$ based on long-term loads.

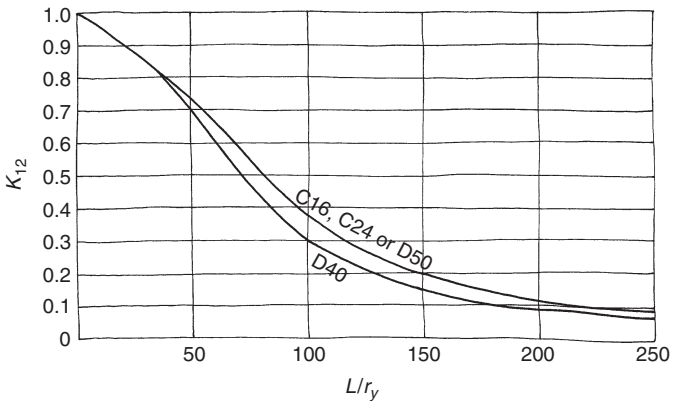

Source: BS 5268: Part 2: 2002.

Deflection and stiffness factor K_9

Generally the limit on deflection of timber structure is $0.003 \times \text{span}$ or height. If this requirement is met, both the elastic and shear deflections are considered to be controlled. In domestic situations the total deflection must also be less than 14 mm. E_{mean} can be used in load-sharing situations. Elsewhere E_{min} should be used, modified by K_9 for trimmer joists and lintels. Glulam can be pre-cambered to compensate for deflections.

Number of pieces of timber making up the element	K_9	
	Softwoods	Hardwoods
1	1.00	1.00
2	1.14	1.06
3	1.21	1.08
≥ 4	1.24	1.10

Source: BS 5268: Part 2: 2002.

Timber joints

The code deals with nailed, screwed, bolted, dowelled and glued joints. Joint positions and fixing edge distances can control member sizes, as a result of the reduced timber cross section at the joint positions. Joint slip (caused by fixings moving in pre-drilled holes) can cause rotations which will have a considerable effect on overall deflections.

Nailed joints

The values given for nailed joints are for nails made from steel wire driven at right angles to the grain. In hardwood, holes normally need to be pre-drilled not bigger than $0.8d$ (where d is the fixing diameter).

Minimum nail spacings for timber to timber joints

The following nail spacings can be reduced for all softwoods (except Douglas fir) by multiplying by 0.8. However, the minimum allowable edge distance should never be less than $5d$.

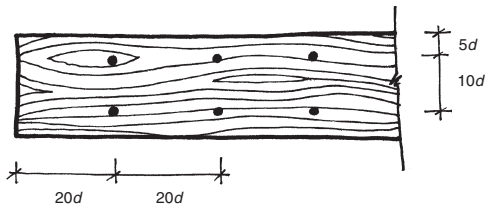

Permissible load for a nailed joint in service classes 1 and 2

$F_{adm} = F \times K_{50} \times n \times$ the number of shear planes

n = the total number of nails in the joint

$K_{50} = 0.9$ for more than 10 nails in a line parallel to the action of the load. For nails driven into the end grain of the timber a further factor of 0.7 should be used. For pre-drilled holes a factor of 1.15 applies

Basic single shear loads for nails in timber to timber joints

Nail diameter mm	Basic shear load kN					
	Softwoods (not pre-drilled)			Hardwoods (pre-drilled)		
	Standard penetration mm	Strength class		Minimum penetration mm	Strength class	
C16		C24	D40		D50	
3	36	0.305	0.325	24	0.464	0.514
4	48	0.493	0.539	32	0.779	0.863
5	60	0.711	0.755	40	1.154	1.278
6	72	0.961	1.021	48	1.594	1.765

Basic single shear loads for nails in timber to plywood joints

Nominal plywood thickness mm	Nail diameter mm	Nail length mm	Basic shear load* kN		
			Softwoods (not pre-drilled)		Hardwoods (pre-drilled)
			C16	C24	D40 and D50
6	3	50	0.256	0.267	0.295
	4	75	0.360	0.360	0.360
12	3	50	0.286	0.296	0.352
	4	75	0.430	0.446	0.545
18	3	50	0.344	0.355	0.417
	4	75	0.485	0.501	0.601
21	3	50	0.359	0.374	0.456
	4	75	0.520	0.537	0.641

*Additional capacity can be achieved for joints into Finnish birch and birch-faced plywoods, see BS 5268: Part 2: 2002: Table 63.

Source: BS 5268: Part 2: 2002: Appendix G.

Screwed joints

The values given for screwed joints are for screws which conform to BS 1210 in pre-drilled holes. The holes should be drilled with a diameter equal to that of the screw shank (ϕ) for the part of the hole to contain the shank, reducing to a pilot hole (with a diameter of $\phi/2$) for the threaded portion of the screw. Where the standard headside thickness is less than the values in the table, the basic load must be reduced by the ratio: actual/standard thickness. The headside thickness must be greater than 2ϕ twice the shank diameter. The following tables give values for UK screws rather than the European screws quoted in the latest British Standard.

Minimum screw spacings

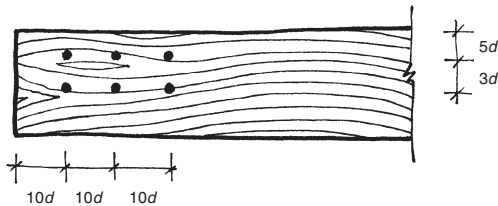

Permissible load for a screwed joint for service classes 1 and 2

$$F_{adm} = F \times K_{54} \times n$$

n = the total number of screws in the joint

$K_{54} = 0.9$ for more than 10 of the same diameter screws in a line parallel to the action of the load. For screws inserted into the end grain of the timber a further factor of 0.7 should be used.

Basic single shear loads for screws in timber to timber joints

Screw		Standard headside thickness mm	Basic single shear kN		
Screw reference	Shank diameter mm		Softwoods		Hardwoods
			C16	C24	D40 and D50
No. 6	3.45	12	0.271	0.303	0.396
No. 8	4.17	16	0.407	0.440	0.584
No. 10	4.88	22	0.526	0.568	0.747
No. 12	5.59	35	0.738	0.796	1.053
No. 14	6.30	38	0.585	0.927	1.227
No. 16	7.01	44	1.005	1.090	1.442

Basic single shear loads for screws in timber to plywood joints

Nominal plywood thickness mm	Screw			Basic single shear* kN			
	Screw reference	Shank diameter mm	Minimum screw length mm	Softwoods		Hardwoods	
				C16	C24	D40	D50
12	No. 6	3.45	38	0.215	0.242	0.284	0.320
	No. 8	4.17	38	0.303	0.326	0.426	0.490
	No. 10	4.88	38	0.356	0.384	0.511	0.592
	No. 12	5.59	38	0.478	0.522	0.712	0.834
	No. 14	6.30	44	0.551	0.603	0.830	0.926
18	No. 6	3.45	57	0.287	0.299	0.351	0.381
	No. 8	4.17	57	0.387	0.399	0.486	0.542
	No. 10	4.88	57	0.429	0.455	0.567	0.638
	No. 12	5.59	57	0.546	0.586	0.755	0.863
	No. 14	6.30	57	0.764	0.829	1.109	1.288

* Extra capacity can be achieved for joints into Finnish birch and birch-faced plywoods, see BS 5268: Part 2: 2002: Table 68.

Source: BS 5268: Part 2: 2002: Appendix G.

Bolted joints

The values given for bolted joints are for black bolts which conform to BS EN 20898-1 with washers which conform to BS 4320. Bolt holes should not be drilled more than 2 mm larger than the nominal bolt diameter. Washers should have a diameter or width of three times the bolt diameter with a thickness of 0.25 times the bolt diameter and be fitted under the head and nut of each bolt. At least one complete thread should protrude from a tightened nut.

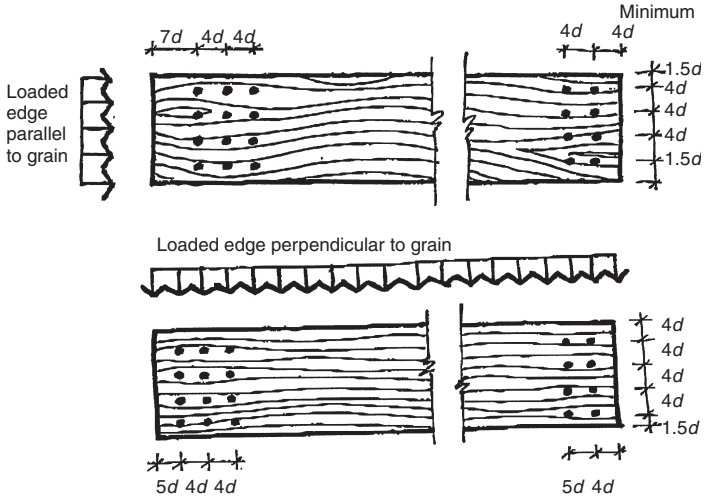

Minimum bolt spacings Permissible load for a bolted joint for service classes 1 and 2

$$F_{adm} = F \times K_{57} \times n$$

n = the total number of bolts in the joint

$K_{57} = 1 - (3(n - 1))/100$ for less than 10 of the same diameter bolts in a line parallel to the action of the load

$K_{57} = 0.7$ for more than 10 of the same diameter bolts in a line parallel to the action of the load

$K_{57} = 1.0$ for all other loading cases where more than one bolt is used in a joint

If a steel plate of minimum thickness 0.3 times the bolt diameter (or 2.5 mm) is bolted to the timber, the basic load can be multiplied by a factor of 1.25. Further improvements on the loads in bolts can be made by using toothed connectors, but these require larger spacings (hence fewer fixings) and correct installation can be difficult.

Basic single shear loads for one grade 4.6 bolt in a two member timber connection

Timber grade	Minimum member thickness (mm)	Basic single shear load for selected grade 4.6 bolt diameters in a two member* timber connection (kN)							
		Direction of loading							
		Parallel to the grain				Perpendicular to the grain			
		M8	M12	M16	M20	M8	M12	M16	M20
C16	47	1.22	1.80	2.30	2.73	1.13	1.56	1.91	2.19
	72	1.46	2.68	3.52	4.19	1.39	2.39	2.93	3.36
	97	1.46	3.13	4.63	5.64	1.39	2.79	3.94	4.52
C24	47	1.33	2.04	2.59	3.09	1.23	1.76	2.16	2.47
	72	1.55	2.93	3.97	4.73	1.47	2.64	3.30	3.79
	97	1.55	3.42	5.05	6.37	1.47	3.07	4.43	5.11
D40	47	1.83	3.08	3.92	4.67	1.83	3.08	3.92	4.67
	72	1.91	4.02	5.98	7.16	1.91	4.02	5.98	7.16
	97	1.91	4.21	6.93	9.32	1.91	4.21	6.93	9.32
D50	47	2.12	3.78	4.81	5.73	2.12	3.78	4.81	5.73
	72	2.12	4.66	6.92	8.78	2.12	4.66	6.92	8.78
	97	2.12	4.66	8.09	10.82	2.12	4.66	8.09	10.82

* Extra capacity for three member connections can be achieved, see BS 5268: Part 2: 2002: Tables 76, 77, 79 and 80.

Source: BS 5268: Part 2: 2002: Appendix G.

7

Masonry

Masonry, brought to the UK by the Romans, became a popular method of construction as the units could originally be lifted and placed with one hand. Masonry has orthotropic material properties relating to the bed or perpendicular joints of the masonry units. The compressive strength of the masonry depends on the strength of the masonry units and on the mortar type. Masonry is good in compression and has limited flexural strength. Where the flexural strength of masonry 'parallel to the bed joints' can be developed, the section is described as 'uncracked'. A cracked section (e.g. due to a damp proof course or a movement joint) relies on the dead weight of the masonry to resist tensile stresses. The structure should be arranged to limit tension or buckling in slender members, or crushing of stocky structures.

Summary of material properties

Clay bricks The wide range of clays in the UK result in a wide variety of available brick strengths, colours and appearance. Bricks can be hand or factory made. Densities range between 22.5 and 28 kN/m³. Clay bricks tend to expand due to water absorption. Engineering bricks have low water absorption, high strength and good durability properties (Class A strength >70 N/mm²; water absorption ≤4.5% by mass. Class B: strength >50 N/mm²; water absorption ≤7.0% by mass).

Calcium silicate bricks Calcium silicates are low cost bricks made from sand and slaked lime rarely used due to their tendency to shrink and crack. Densities range between 17 and 21 kN/m³.

Concrete blocks Cement bound blocks are available in densities ranging between 5 and 20 kN/m³. The lightest blocks are aerated; medium dense blocks contain slag, ash or pumice aggregate; dense blocks contain dense natural aggregates. Blocks can shrink by 0.01–0.09%, but blocks with shrinkage rates of no more than 0.03% are preferable to avoid the cracking of plaster and brittle finishes on the finished walls.

Stone masonry Stone as rubble construction, bedded blocks or as facing to brick or blockwork is covered in BS 5390. Thin stone used as cladding or facing is covered by BS 8298.

Cement mortar Sand, dry hydrate of lime and cement are mixed with water to form mortar. The cement cures on contact with water. It provides a bond strong enough that the masonry can resist flexural tension, but structural movement will cause cracking.

Lime mortar Sand and non-hydraulic lime putty form a mortar, to which some cement (or other pozzolanic material) can be added to speed up setting. The mortar needs air, and warm, dry weather to set. Lime mortar is more flexible than cement mortar and therefore can resist considerably more movement without visible cracking.

Typical unit strengths of masonry

Material (relevant BS)	Class	Water absorption	Typical unit compressive strength N/mm ²
Fired clay bricks (BS 3921)	Engineering A	<4.5%	>70
	Engineering B	7.0%	>50
	Facings (bricks selected for appearance)	10–30%	10–50
	Commons (Class 1 to 15)	20–24%	
	Class 1		7
	Class 2		14
	Class 3		20
	Class 15		105
Flettons	15–25%	15–25	
Stocks (bricks without frogs)	20–40%	3–20	
Calcium silicate bricks (BS 187)	Classes 2 to 7		14–48.5
Concrete bricks (BS 6073: Pt 1)			7–20
Concrete blocks (BS 6073: Pt 1)	Dense solid		7, 10–30
	Dense hollow		3.5, 7, 10
	Lightweight		2.8, 3.5, 4, 7
Reconstituted stone (BS 6457)	Dense solid		Typically as dense concrete blocks
Natural stone (BS 5390 and BS 8298)	Structural quality. Strength is dependent on the type of stone, the quality, the direction of the bed, the quarry location		15–100

Geometry and arrangement

Brick and block sizes

The standard UK brick is $215 \times 102 \times 65$ mm which gives a co-ordinating size of $225 \times 112 \times 75$ mm. The standard UK block face size is 440×215 mm in thicknesses from 75 to 215 mm, giving a co-ordinating size of 450×225 mm. This equates to two brick stretchers by three brick courses.

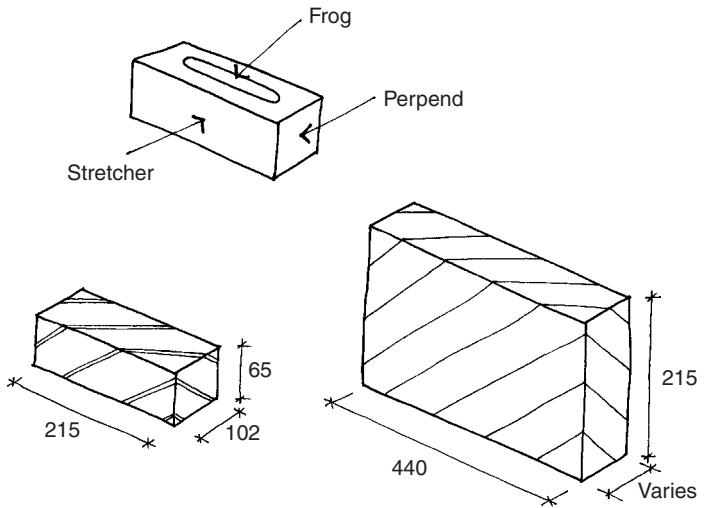

The Health and Safety Executive (HSE) require designers to specify blocks which weigh less than 20 kg to try to reduce repetitive strain injuries in bricklayers. Medium dense and dense blocks of 140 mm thick, or more, often exceed 20 kg. The HSE prefers designers to specify half blocks (such as Tarmac Topcrete) rather than rely on special manual handling (such as hoists) on site. In addition to this, the convenience and speed of block laying is reduced as block weight increases.

Non-hydraulic lime mortar mixes for masonry

Mix constituents	Approximate proportions by volume	Notes on general application
Lime putty:coarse sand	2:5	Used where dry weather and no frost are expected for several months
Pozzolanic*:lime putty:coarse sand	1:2–3:2	Used where an initial mortar set is required within a couple of days

* Pozzolanic material can be cement, fired china dust or ground granulated blast furnace slag (ggbfsl).

The actual amount of lime putty used depends on the grading of the sand and the volume of voids. Compressive strength values for non-hydraulic lime mortar masonry can be approximated using the values for Class IV cement mortar. Due to the flexibility of non-hydraulic lime mortar, thermal and moisture movements can generally be accommodated by the masonry without cracking of the masonry elements or the use of movement joints. This flexibility also means that resistance to lateral load relies on mass and dead load rather than flexural strength. The accepted minimum thickness of walls with non-hydraulic lime mortar is 215 mm and therefore the use of lime mortar in standard single leaf cavity walls is not appropriate.

Cement mortar mixes for masonry

Mortar class	Type of mortar (proportions by volume)			Compressive strengths N/mm ²	
	Cement:lime:sand	Masonry cement:sand	Cement:sand with plasticizer	Lab	Site
Dry pack	1:0:3	–	–	–	–
I	1:¼:3	–	–	16.0	11.0
II	1:½:4 to 4½	1:2½ to 3½	1:3 to 4	6.5	4.5
III	1:1:5 to 6	1:4 to 5	1:5 to 6	3.6	2.5
IV	1:2:8 to 9	1:5½ to 6½	1:7 to 8	1.5	1.0

NOTES:

- Mix proportions are given by volume. Where sand volumes are given as variable amounts, use the larger volume for well-graded sand and the smaller volume for uniformly graded sand.
- As the mortar strength increases, the flexibility reduces and likelihood of cracking increases.
- Cement:lime:sand mortar provides the best bond and rain resistance, while cement:sand and plasticizer is more frost resistant.

Source: BS 5628: Part 1: 1992.

Selected bond patterns

For strength, perpends should not be less than one quarter of a brick from those in an adjacent course.

English
bond

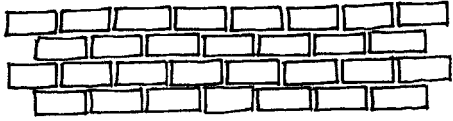

Flemish
bond

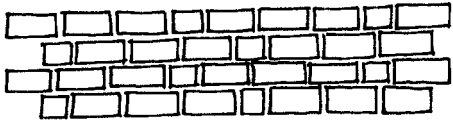

English garden
wall bond

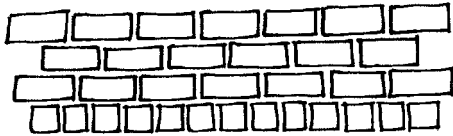

Flemish garden
wall bond

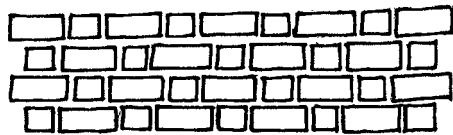

Stretcher bond

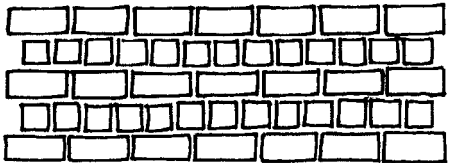

Movement joints in masonry with cement-based mortar

Movement joints to limit the lengths of walls built in cement mortar are required to minimize cracking due to deflection, differential settlement, temperature change and shrinkage or expansion. In addition to long wall panels, movement joints are also required at points of weakness, where stress concentrations might be expected to cause cracks (such as at steps in height or thickness or at the positions of large chases). Typical movement joint spacings are as follows:

Material	Approximate horizontal joint spacing ² and reason for provision	Typical joint thickness mm	Maximum suggested panel length:height ratio ¹
Clay bricks	12 m for expansion	16	3:1
	15–18 m with bed joint reinforcement at 450 mm c/c	22	
	18–20 m with bed joint reinforcement at 225 mm c/c	25	
Calcium silicate bricks	7.5–9 m for shrinkage	10	3:1
Concrete bricks	6 m for shrinkage	10	2:1
Concrete blocks	6–7 m for shrinkage	10	2:1
	15–18 m with bed joint reinforcement at 450 mm c/c	22	
	18–20 m with bed joint reinforcement at 225 mm c/c	25	
Natural stone cladding	6 m for thermal movements	10	3:1

NOTES:

1. Consider bed joint reinforcement for ratios beyond the suggested maximum.
2. The horizontal joint spacing should be halved for joints which are spaced off corners.

Vertical joints are required in cavity walls every 9 m or three storeys for buildings over 12 m or four storeys. This vertical spacing can be increased if special precautions are taken to limit the differential movements caused by the shrinkage of the internal block and the expansion of the external brick. The joint is typically created by supporting the external skin on a proprietary stainless steel shelf angle fixed back to the internal structure. Normally 1 mm of joint width is allowed for each metre of masonry (with a minimum of 10 mm) between the top of the masonry and underside of the shelf angle support.

Durability and fire resistance

Durability

Durability of masonry relies on the selection of appropriate components detailed to prevent water and weather penetration. Wet bricks can suffer from spalling as a result of frost attack. Bricks of low porosity are required in positions where exposure to moisture and freezing is likely. BS 5268: Part 3 gives guidance on recommended combinations of masonry units and mortar for different exposure conditions as summarized:

Durability issues for selection of bricks and mortar

Application		Minimum strength of masonry unit	Mortar class ¹	Brick frost resistance ² and soluble salt content ³
Internal walls generally/external walls above DPC		Any block/15 N/mm ² brick	III	FL, FN, ML, MN, OL or ON
External below DPC/freestanding walls/parapets		7 N/mm ² dense block/20 N/mm ² brick	III	FL or FN (ML or MN if protected from saturation)
Brick damp proof courses in buildings (BS 743)		Engineering brick A	I	FL or
Earth retaining walls		7 N/mm ² dense block/30 N/mm ² brick	I or II	FL or FN
Planter boxes		Engineering brick/20 N/mm ² commons	I or II	FL or FN
Sills and copings		Selected block/30 N/mm ² brick	I	FL or FN
Manholes and inspection chambers	Surface water	Engineering brick/20 N/mm ² commons	I or II	FL or FN (ML or MN if more than 150 mm below ground level)
	Foul drainage	Engineering brick A	I or II	

NOTES:

1. Sulphate resisting mortar is advised where soluble sulphates are expected from the ground, saturated bricks or elsewhere.
2. F indicates that the bricks are frost resistant, M indicates moderate frost resistance and O indicates no frost resistance.
3. N indicates that the bricks have normal soluble salt content and L indicates low soluble salt content.
4. Retaining walls and planter boxes should be waterproofed on their retaining faces to improve durability and prevent staining.

Fire resistance

As masonry units have generally been fired during manufacture, their performance in fire conditions is generally good. Perforated and cellular bricks have a lesser fire resistance than solid units of the same thickness. The fire resistance of blocks is dependent on the grading of the aggregate and cement content of the mix, but generally 100 mm solid blocks will provide a fire resistance of up to 2 hours if load bearing and 4 hours if non-load bearing. Longer periods of fire resistance may require a thicker wall than is required for strength. Specific product information should be obtained from masonry manufacturers.

Preliminary sizing of masonry elements

Typical span/thickness ratios

Description	Typical thickness		
	Freestanding/ cantilever	Element supported on two sides	Panel supported on four sides
Lateral loading			
Solid wall with no piers – uncracked section	$H/6-8.5^1$	$H/20$ or $L/20$	$H/22$ or $L/25$
Solid wall with no piers – cracked section	$H/4.5-6.4^1$	$H/10$ or $L/20$	$H/12$ or $L/25$
External cavity wall ² panel	–	$H/20$ or $L/30$	$H/22$ or $L/35$
External cavity wall ² panel with bed joint reinforcement	–	$H/20$ or $L/35$	$H/22$ or $L/40$
External diaphragm wall panel	$H/10$	$H/14$	–
Reinforced masonry retaining wall (bars in pockets in the walls)	$H/10-15$		
Solid masonry retaining wall (thickness at base)	$H/2.5-4$	–	–
Vertical loading			
Solid wall	$H/8$	$H/18-22$	–
Cavity wall	$H/11$	$H/5.5$	–
Masonry arch/vault	–	$L/20-30$	$L/30-60$
Reinforced brick beam depth	–	$L/10-16$	–

NOTES:

1. Depends on the wind exposure of the wall.
2. The spans or distances between lateral restraints are L in the horizontal direction and H in the vertical direction.
3. In cavity walls, the thickness is the sum of both leaves excluding the cavity width.

Vertical load capacity wall charts

Vertical load capacity of selected walls less than 150 mm thick

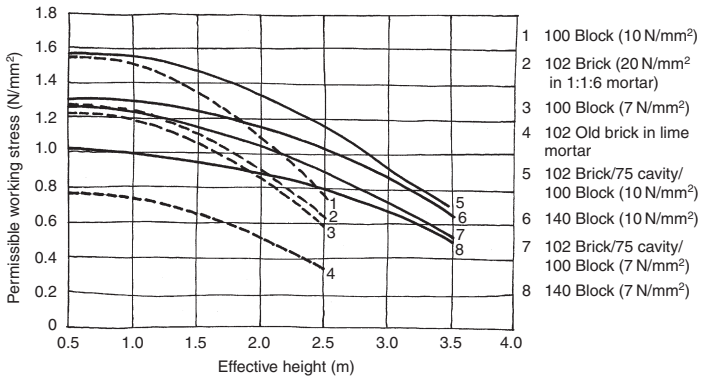

Vertical load capacity of selected solid walls greater than 150 mm thick

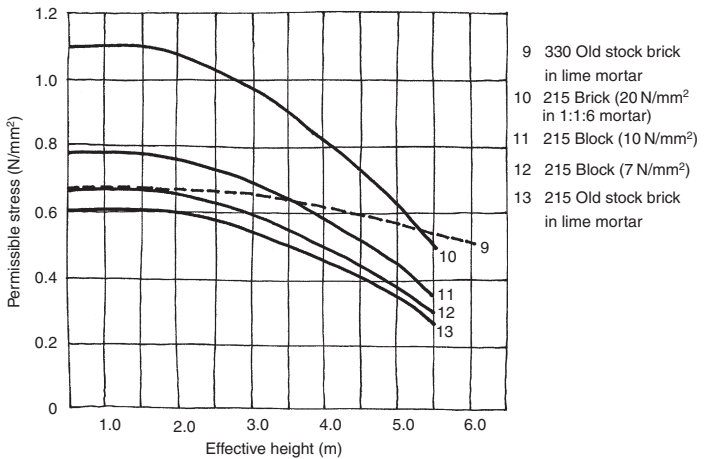

Preliminary sizing of external cavity wall panels

The following approach can be considered for cavity wall panels in non-load bearing construction up to about 3.5 m tall in buildings of up to four storeys high, in areas which have many windbreaks. Without major openings, cavity wall panels can easily span up to 3.5 m if spanning horizontally, while panels supported on four sides can span up to about 4.5 m. Load bearing wall panels can be larger as the vertical loads pre-compress the masonry and give it much more capacity to span vertically. Gable walls can be treated as rectangular panels and their height taken as the average height of the wall.

Detailed calculations for masonry around openings can sometimes be avoided if:

1. The openings are completely framed by lateral restraints.
2. The total area of openings is less than the lesser of: 10% of the maximum panel area (see the section on the design of external wall panels to BS 5628 under 'Lateral load' later in this chapter) or 25% of the actual wall area.
3. The opening is more than half its maximum dimension from any edge of the wall panel (other than its base) and from any adjacent opening.

Internal non-loadbearing masonry partition chart

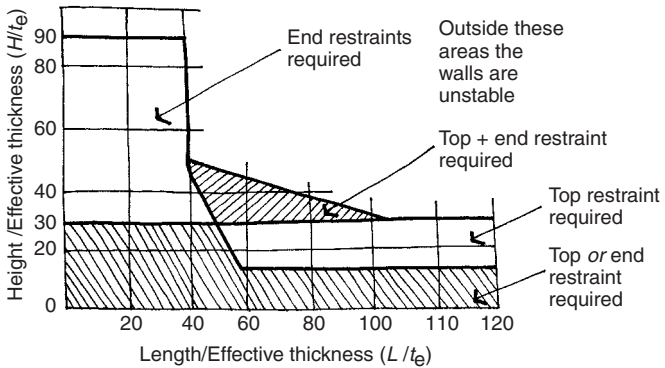

Typical ultimate strength values for stone masonry

	Crushing N/mm^2	Tension N/mm^2	Shear N/mm^2	Bending N/mm^2
Basalt	8.5	8.6	4.3	–
Chalk	1.1	–	–	–
Granite	96.6	3.2	5.4	10.7
Limestone	53.7	2.7	4.3	6.4
Limestone soft	10.7	1.0	3.8	5.4
Marble	64.4	3.2	5.4	–
Sandstone	53.7	1.1	3.2	5.4
Sandstone soft	21.5	0.5	1.1	2.1
Slate	85.8	1.1	3.2	5.4

The strength values listed above assume that the stone is of good average quality and that the factor of safety commonly used was 10. While this seems sensible for tension, shear and bending it does seem conservative for crushing strength. Better values can be achieved on the basis of strength testing. These values can be used in preliminary design, but where unknown stones or unusual uses are proposed, strength testing is advised. The strength of stone varies between sources and samples, and also depends on the mortar and the manner of construction. The British Stone website has listings of stone tests carried out by the Building Research Establishment (BRE).

As compressive load can be accompanied by a shear stress of up to half the compressive stress, shear stresses normally control the design of slender items such as walls and piers. Safe wall and pier loads are generally obtained by assuming a safe working compressive stress equal to twice the characteristic shear stress.

Sources: BS 5628: Part 3: 2001;
Howe, J.A. (1910).

Masonry design to BS 5628

Partial safety factors

Load combination	Load type			
	Dead	Imposed	Wind	Earth and water
Dead and imposed	1.4 or 0.9	1.6	–	1.2
Dead and wind	1.4 or 0.9	–	1.4*	1.2
Dead and wind (freestanding walls)	1.4 or 0.9	–	1.2*	–
Dead, imposed or wind	1.2	1.2	1.2*	1.2
Accidental damage	0.95 or 1.05	0.35 or 1.05	0.35	–

* Buildings should be capable of resisting a horizontal load equal to 1.5% of the total characteristic dead load (i.e. $0.015G_k$) above any level. In some instances $0.015G_k$ can be greater than the applied wind loadings.

The factor of safety for the compressive strength of materials is generally taken as $\gamma_{mc} = 3.5$ while the factor of safety for flexural strength of materials has recently been reduced to $\gamma_{mf} = 3.0$ (assuming normal control of manufacture and construction). Tables 4a and 4b in BS 5628 allow these material safety factors to be reduced if special controls on manufacture and construction are in place.

Notation for BS 5628: Part 1

Symbols	Subscripts			
	Type of stress	Significance	Geometry	
f Stress	k Compression	a Applied		Parallel to the bed joints
	k_x Bending	adm Permissible	⊥	Perpendicular to the bed joints
	v Shear			

In addition:

μ The orthogonal ratio is the ratio of the flexural strengths in different directions,
 $\mu = fk_{x_{||}}/fk_{x_{\perp}}$.

α Panel factor (determined by μ and panel size) which attempts to model how a panel with orthogonal properties distributes lateral load between the stronger (perpendicular to the bed joints) and the weaker (parallel to the bed joints) directions.

Source: BS 5628: Part 1: 1992.

Vertical load

Selected characteristic compressive masonry strengths for standard format brick masonry (N/mm²)

Mortar class	Compressive strength of unit N/mm ²								
	5	10 Stock	15	20 Fletton	27.5	35	50 Class B	70 Class A	100 Class A
I	2.5	4.4	6.0	7.4	9.2	11.4	15.0	19.2	24.0
II	2.5	4.2	5.3	6.4	7.9	9.4	12.2	15.1	18.2
III	2.5	4.1	5.0	5.8	7.1	8.5	10.6	13.1	15.5
IV	2.5	3.5	4.4	5.2	6.2	7.3	9.0	10.8	12.7

Selected characteristic compressive masonry strengths for concrete block masonry (N/mm²)

Mortar class and type of unit	Compressive strength of unit N/mm ²								
	2.8	3.5	5.0	7.0	10	15	20	≥35	
100 mm solid or concrete filled hollow blocks									
II	2.8	3.5	5.0	6.4	8.4	10.6	12.8	18.8	
III	2.8	3.5	5.0	6.4	8.2	10.0	11.6	17.0	
140 mm solid or concrete filled hollow blocks									
II	2.3	2.9	4.2	5.3	7.0	8.9	10.7	15.7	
III	2.3	2.9	4.2	5.3	6.9	8.4	9.7	14.2	
215 mm solid concrete block wall (made up with 100 mm solid blocks laid on side)									
II	1.4	1.7	2.5	3.2	4.2	5.3	6.4	9.4	
III	1.4	1.7	2.5	3.2	4.1	5.0	5.8	8.5	

NOTES to both tables:

- For columns or piers with cross sectional area, $A < 0.2 \text{ m}^2$ f_k should be multiplied by $\gamma_{col} = (0.7 + 1.5A)$.
- Where a brick wall is 102 mm thick f_k can be multiplied by $\gamma = 1.15$, but wide format bricks need a reduction factor in accordance with BS 5628 cl. 23.1.4.
- Natural stone masonry can be taken on the same values as concrete blocks of the same strength, but random rubble masonry in cement mortar should be considered to have 75% of this strength. Random rubble masonry in lime mortar can be considered to have a characteristic strength of 50% of the equivalent concrete blocks in Class IV mortar.

Source: BS 5628: Part 1: 1992.

Effective thickness

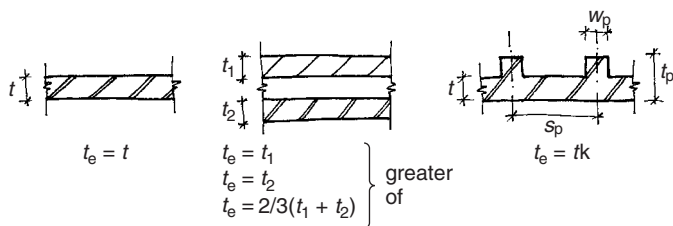

Stiffness coefficient k for walls stiffened by piers

Ratio of pier spacing (centre to centre) to pier width S_p/W_p	Ratio of pier thickness to wall thickness, t_p/t		
	1	2	3
≤ 6	1.0	1.4	2.0
10	1.0	1.2	1.4
≥ 20	1.0	1.0	1.0

Linear interpolation (but not extrapolation) is permitted.

Source: BS 5628: Part 1: 1992.

Effective height or length

Lateral supports should be able to carry any applied horizontal loads or reactions plus 2.5 per cent of the total vertical design load in the element to be laterally restrained. The effective height of a masonry wall depends on the horizontal lateral restraint provided by the floors or roofs supported on the wall. The effective length of a masonry wall depends on the vertical lateral restraint provided by cross walls, piers or returns. BS 5268: Part 1: clause 28.2 and Appendix C define the types of arrangement which provide simple or enhanced lateral restraint. The slenderness ratio of a masonry element should generally not exceed 27. For walls of less than 90 mm thick in buildings of two storeys or more, the slenderness should not exceed 20.

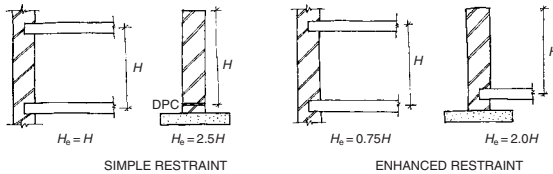

Horizontal resistance to lateral movement

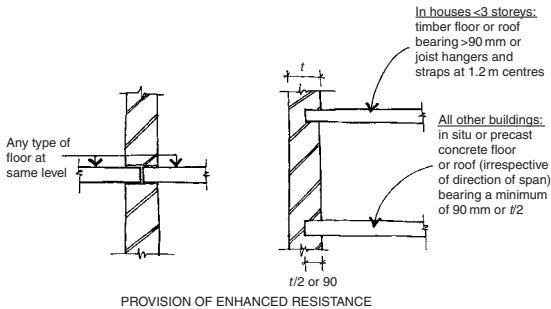

Vertical resistance to lateral movement

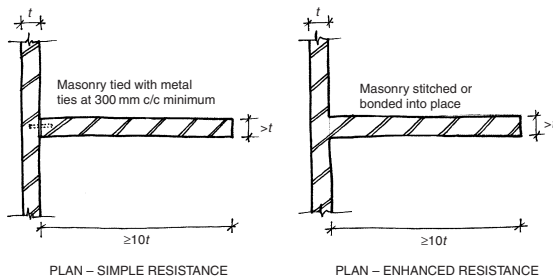

Sources: BS 5628: Part 1: 1992;
BS 5268: Part 3: 2001.

Slenderness reduction factor β

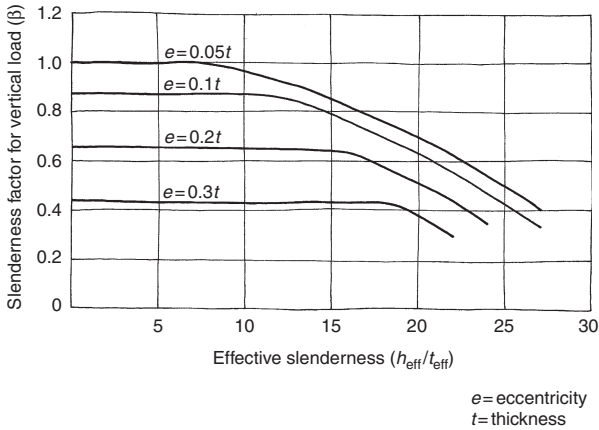

Vertical load resistance of walls and columns

Wall:
$$F_{k_{adm}} = \frac{(\beta t f_k)}{\gamma_m}$$

Column:
$$F_{k_{adm}} = \frac{(\beta b t f_k) \gamma_{col}}{\gamma_m}$$

t is the actual (not the effective thickness), b is the column width, β is the slenderness reduction factor, γ_{col} is the column reduction factor, γ_m is the factor of safety for materials and workmanship and f_k is the characteristic compressive strength of the masonry.

Additional factors (as listed in the notes below the tabulated values of f_k) may also be applied for the calculation of load resistance.

Shear strength

$$f_v = \frac{f_{v0}}{\gamma_m}$$

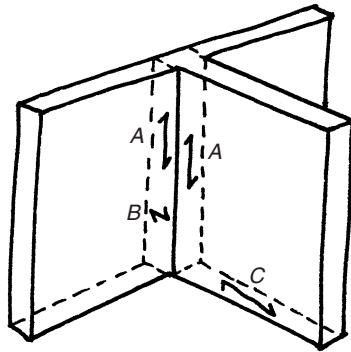

- A** Complementary shear acting in the vertical direction of the vertical plane.

$f_{v0} = 0.7 \text{ N/mm}^2$ for bricks in I and II mortar or 0.5 N/mm^2 for bricks in III and IV mortar

$f_{v0} = 0.35 \text{ N/mm}^2$ for 7 N/mm^2 blocks.

- B** Complementary shear acting in the horizontal direction of the vertical plane:

- C** Shear acting in the horizontal direction of the horizontal plane:

$f_{v0} = (0.35 + 0.6G_a) \text{ N/mm}^2$

to a maximum of 1.75 N/mm^2 for I and II mortar, or $f_{v0} = (0.15 + 0.6G_a) \text{ N/mm}^2$ to a maximum of 1.4 N/mm^2 for III and IV mortar.









Lateral load

Wind zone map

The sizes of external wall panels are limited depending on the elevation of the panel above the ground and the typical wind speeds expected for the site.



Maximum permitted panel areas for external cavity wall panels* (m²)

Wind zone	Height above ground m	Panel type								
		A	B	C	D	E	F	G	H	I
										
1	5.4	11.0	17.5	26.5	20.5	32.0	32.0	8.5	14.0	19.5
	10.8	9.0	13.0	17.5	15.5	24.0	32.0	7.0	10.0	15.5
2	5.4	9.5	14.0	21.0	17.5	27.0	32.0	7.5	10.5	17.0
	10.8	8.0	11.5	13.5	13.0	19.0	28.0	6.0	9.0	13.0
3	5.4	8.5	12.5	15.5	14.5	22.0	30.5	6.5	9.5	14.5
	10.8	7.0	10.0	11.5	11.0	14.5	24.5	5.0	7.5	11.5
4	5.4	8.0	11.0	13.0	12.5	18.0	27.0	6.0	8.5	12.5
	10.8	6.5	9.0	10.5	9.5	12.5	21.5	4.0	6.5	10.0

*The values in the table are given for cavity walls with leaves of 100 mm block inner skin. If either leaf is increased to 140 mm the maximum permitted areas in the table can be increased by 20%.

No dimension of unreinforced masonry panels should generally exceed 50 × effective thickness. Reinforced masonry panels areas can be about 20% bigger than unreinforced panels and generally no dimension should exceed 60 × effective thickness.

Source: BS 5268: Part 3: 2001.

Characteristic flexural strength of masonry

The characteristic flexural strength of masonry works on the assumption that the masonry section is uncracked and therefore can resist some tensile stresses. If the wall is carrying some compressive load, then the wall will have an enhanced resistance to tensile stresses. Where tension develops which exceeds the tensile resistance of the masonry (e.g. at a DPC or crack location) the forces must be resisted by the dead loads alone and therefore the wall will have less capacity than an uncracked section.

Type of masonry unit	Plane of failure				Basic orthogonal ratio, μ^*	
	Parallel to the bed joints $f_{kx }$		Perpendicular to the bed joints $f_{kx\perp}$			
	Mortar I N/mm ²	II & III N/mm ²	I N/mm ²	II & III N/mm ²	I N/mm ²	II & III N/mm ²
Clay bricks having a water absorption of: less than 7% between 7% and 12% over 12%	0.7	0.5	2.0	1.5	0.35	0.33
	0.5	0.4	1.5	1.1	0.33	0.36
	0.4	0.3	1.1	0.9	0.36	0.33
Calcium silicate or concrete bricks		0.3		0.9		0.33
7 N/mm ² concrete blocks: 100 mm wide wall 140 mm wide wall 215 mm wide wall						
		0.25		0.6		0.41
		0.27		0.66		0.40
		0.32		0.79		0.40
Any thickness concrete block walls: 10.5 N/mm ² ≥ 14.0 N/mm ²						
		0.25		0.75		0.33
		0.25		0.9		0.30

* The orthogonal ratio, $\mu = f_{kx||}/f_{kx\perp}$, can be improved if $f_{kx||}$ is enhanced by the characteristic dead load:
 $f_{kx||\text{enhanced}} = f_{kx||}/\gamma_m + 0.9 G_k$.

Source: BS 5628: Part 1: 1992.

Ultimate moments applied to wall panels

The flexural strength of masonry parallel to the bed joints is about a third of the flexural strength perpendicular to the bed joints. The overall flexural capacity of a panel depends on the dimensions, orthogonal strength ratio and support conditions of that panel. BS 5628: Part 1 uses α (which is based on experimental data and yield line analysis) to estimate how a panel will combine these different orthogonal properties to distribute the applied lateral loads and express this as a moment in one direction:

$$M_{a||} = \mu\alpha\gamma_f W_k L^2$$

W_k is the applied distributed lateral load panel, L is the horizontal panel length and $M_{a\perp} = M_{a||}/\mu$. Therefore the applied moment need only be checked against the flexural strength in one direction.

Ultimate flexural strength of an uncracked wall spanning horizontally

$$M_{adm\perp} = \left(\frac{f_{kx\perp}}{\gamma_m} \right) Z$$

Ultimate flexural strength of an uncracked wall spanning vertically

$$M_{adm||} = \left(\frac{f_{kx||}}{\gamma_m} + 0.9G_k \right) Z$$

The flexural strength parallel to the bed joints varies with the applied dead load and the height of the wall. Therefore the top half of non-load bearing walls are normally the critical case. There are published tables for non-load bearing and freestanding walls which greatly simplify calculations.

Ultimate flexural strength of a cracked wall spanning vertically

$$M_{adm||} = \frac{\gamma_w t^2 h}{2\gamma_f}$$

The dead weight of the wall is used to resist lateral loads. Tension can be avoided if the resultant force is kept within the middle third of the wall. Where γ_f is an appropriate factor of safety against overturning.

Bending moment coefficients in laterally loaded wall panels

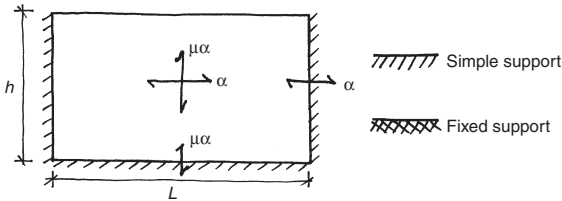

Panel support conditions	Orthogonal ratio μ	Values of panel factor, α							
		h/L							
		0.30	0.50	0.75	1.00	1.25	1.50	1.75	
A 	1.00	0.031	0.045	0.059	0.071	0.079	0.085	0.090	
	0.90	0.032	0.047	0.061	0.073	0.081	0.087	0.092	
	0.80	0.034	0.049	0.064	0.075	0.083	0.089	0.093	
	0.70	0.035	0.051	0.066	0.077	0.085	0.091	0.095	
	0.60	0.038	0.053	0.069	0.080	0.088	0.093	0.097	
	0.50	0.040	0.056	0.073	0.083	0.090	0.095	0.099	
	0.40	0.043	0.061	0.077	0.087	0.093	0.098	0.101	
	0.35	0.045	0.064	0.080	0.089	0.095	0.100	0.103	
	0.30	0.048	0.067	0.082	0.091	0.097	0.101	0.104	
B 	1.00	0.024	0.035	0.046	0.053	0.059	0.062	0.065	
	0.90	0.025	0.036	0.047	0.055	0.060	0.063	0.066	
	0.80	0.027	0.037	0.049	0.056	0.061	0.065	0.067	
	0.70	0.028	0.039	0.051	0.058	0.062	0.066	0.068	
	0.60	0.030	0.042	0.053	0.059	0.064	0.067	0.069	
	0.50	0.031	0.044	0.055	0.061	0.066	0.069	0.071	
	0.40	0.034	0.047	0.057	0.063	0.067	0.070	0.072	
	0.35	0.035	0.049	0.059	0.065	0.068	0.071	0.073	
	0.30	0.037	0.051	0.061	0.066	0.070	0.072	0.074	
C 	1.00	0.020	0.028	0.037	0.042	0.045	0.048	0.050	
	0.90	0.021	0.029	0.038	0.043	0.046	0.048	0.050	
	0.80	0.022	0.031	0.039	0.043	0.047	0.049	0.051	
	0.70	0.023	0.032	0.040	0.044	0.048	0.050	0.051	
	0.60	0.024	0.034	0.041	0.046	0.049	0.051	0.052	
	0.50	0.025	0.035	0.043	0.047	0.050	0.052	0.053	
	0.40	0.027	0.038	0.044	0.048	0.051	0.053	0.054	
	0.35	0.029	0.039	0.045	0.049	0.052	0.053	0.054	
	0.30	0.030	0.040	0.046	0.050	0.052	0.054	0.055	
D 	1.00	0.013	0.021	0.029	0.035	0.040	0.043	0.045	
	0.90	0.014	0.022	0.031	0.036	0.040	0.043	0.046	
	0.80	0.015	0.023	0.032	0.038	0.041	0.044	0.047	
	0.70	0.016	0.025	0.033	0.039	0.043	0.045	0.047	
	0.60	0.017	0.026	0.035	0.040	0.044	0.046	0.048	
	0.50	0.018	0.028	0.037	0.042	0.045	0.048	0.050	
	0.40	0.020	0.031	0.039	0.043	0.047	0.049	0.051	
	0.35	0.022	0.032	0.040	0.044	0.048	0.050	0.051	
	0.30	0.023	0.034	0.041	0.046	0.049	0.051	0.052	

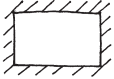
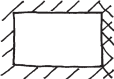
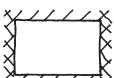
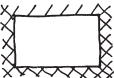
E 	1.00	0.008	0.018	0.030	0.042	0.051	0.059	0.066
	0.90	0.009	0.019	0.032	0.044	0.054	0.062	0.068
	0.80	0.010	0.021	0.035	0.046	0.056	0.064	0.071
	0.70	0.011	0.023	0.037	0.049	0.059	0.067	0.073
	0.60	0.012	0.025	0.040	0.053	0.062	0.070	0.076
	0.50	0.014	0.028	0.044	0.057	0.066	0.074	0.080
	0.40	0.017	0.032	0.049	0.052	0.071	0.078	0.084
	0.35	0.018	0.035	0.052	0.064	0.074	0.081	0.086
	0.30	0.020	0.038	0.055	0.068	0.077	0.083	0.089
F 	1.00	0.008	0.016	0.026	0.034	0.041	0.046	0.051
	0.90	0.008	0.017	0.027	0.036	0.042	0.048	0.052
	0.80	0.009	0.018	0.029	0.037	0.044	0.049	0.054
	0.70	0.010	0.020	0.031	0.039	0.046	0.051	0.055
	0.60	0.011	0.022	0.033	0.042	0.048	0.053	0.057
	0.50	0.013	0.024	0.036	0.044	0.051	0.056	0.059
	0.40	0.015	0.027	0.039	0.048	0.054	0.058	0.062
	0.35	0.016	0.029	0.041	0.050	0.055	0.060	0.063
	0.30	0.018	0.031	0.044	0.052	0.057	0.062	0.065
G 	1.00	0.007	0.014	0.022	0.028	0.033	0.037	0.040
	0.90	0.008	0.015	0.023	0.029	0.034	0.038	0.041
	0.80	0.008	0.016	0.024	0.031	0.035	0.039	0.042
	0.70	0.009	0.017	0.026	0.032	0.037	0.040	0.043
	0.60	0.010	0.019	0.028	0.034	0.038	0.042	0.044
	0.50	0.011	0.021	0.030	0.036	0.040	0.043	0.046
	0.40	0.013	0.023	0.032	0.038	0.042	0.045	0.047
	0.35	0.014	0.025	0.033	0.039	0.043	0.046	0.048
	0.30	0.016	0.026	0.035	0.041	0.044	0.047	0.049
H 	1.00	0.005	0.011	0.018	0.024	0.029	0.033	0.036
	0.90	0.006	0.012	0.019	0.025	0.030	0.034	0.037
	0.80	0.006	0.013	0.020	0.027	0.032	0.035	0.038
	0.70	0.007	0.014	0.022	0.028	0.033	0.037	0.040
	0.60	0.008	0.015	0.024	0.030	0.035	0.038	0.041
	0.50	0.009	0.017	0.025	0.032	0.036	0.040	0.043
	0.40	0.010	0.019	0.028	0.034	0.039	0.042	0.045
	0.35	0.011	0.021	0.029	0.036	0.040	0.043	0.046
	0.30	0.013	0.022	0.031	0.037	0.041	0.044	0.047

Bending moment coefficients in laterally loaded wall panels – continued

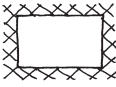
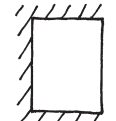
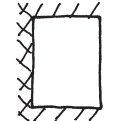
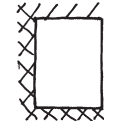
Panel support conditions	Orthogonal ratio μ	Values of panel factor, α						
		h/L						
		0.30	0.50	0.75	1.00	1.25	1.50	1.75
	1.00	0.004	0.009	0.015	0.021	0.026	0.030	0.033
	0.90	0.004	0.010	0.016	0.022	0.027	0.031	0.034
	0.80	0.005	0.010	0.017	0.023	0.028	0.032	0.035
	0.70	0.005	0.011	0.019	0.025	0.030	0.033	0.037
	0.60	0.006	0.013	0.020	0.026	0.031	0.035	0.038
	0.50	0.007	0.014	0.022	0.028	0.033	0.037	0.040
	0.40	0.008	0.016	0.024	0.031	0.035	0.039	0.042
	0.35	0.009	0.017	0.026	0.032	0.037	0.040	0.043
	0.30	0.010	0.019	0.028	0.034	0.038	0.042	0.044
		1.00	0.009	0.023	0.046	0.071	0.096	0.122
0.90		0.010	0.026	0.050	0.076	0.103	0.131	0.162
0.80		0.012	0.028	0.054	0.083	0.111	0.142	0.175
0.70		0.013	0.032	0.060	0.091	0.121	0.156	0.191
0.60		0.015	0.036	0.067	0.100	0.135	0.173	0.211
0.50		0.018	0.042	0.077	0.133	0.153	0.195	0.237
0.40		0.021	0.050	0.090	0.131	0.177	0.225	0.272
0.35		0.024	0.055	0.098	0.144	0.194	0.244	0.296
0.30		0.027	0.062	0.108	0.160	0.214	0.269	0.325
		1.00	0.009	0.021	0.038	0.056	0.074	0.091
	0.90	0.010	0.023	0.041	0.060	0.079	0.097	0.113
	0.80	0.011	0.025	0.045	0.065	0.084	0.103	0.120
	0.70	0.012	0.028	0.049	0.070	0.091	0.110	0.128
	0.60	0.014	0.031	0.054	0.077	0.099	0.119	0.138
	0.50	0.016	0.035	0.061	0.085	0.109	0.130	0.149
	0.40	0.019	0.041	0.069	0.097	0.121	0.144	0.164
	0.35	0.021	0.045	0.075	0.104	0.129	0.152	0.173
	0.30	0.024	0.050	0.082	0.112	0.139	0.162	0.183
		1.00	0.006	0.015	0.029	0.044	0.059	0.073
0.90		0.007	0.017	0.032	0.047	0.063	0.078	0.093
0.80		0.008	0.018	0.034	0.051	0.067	0.084	0.099
0.70		0.009	0.021	0.038	0.056	0.073	0.090	0.106
0.60		0.010	0.023	0.042	0.061	0.080	0.098	0.115
0.50		0.012	0.027	0.048	0.068	0.089	0.108	0.126
0.40		0.014	0.032	0.055	0.078	0.100	0.121	0.139
0.35		0.016	0.035	0.060	0.084	0.108	0.129	0.148
0.30		0.018	0.039	0.066	0.092	0.116	0.138	0.158

NOTES:

- Linear interpolation of μ and h/L is permitted.
- When the dimensions of a wall are outside the range of h/L given in this table, it will usually be sufficient to calculate the moments on the basis of a simple span. For example, a panel of type A having h/L less than 0.3 will tend to act as a freestanding wall, while the same panel having h/L greater than 1.75 will tend to span horizontally.

Source: BS 5628: Part 1: 1992.

Concentrated loads

Increased stresses are permitted under and close to the bearings of concentrated loads. The load is assumed to be spread uniformly beneath the bearing. The effect of this bearing pressure in combination with the stresses in the wall due to other loads should be less than the design bearing strength.

Location	Design bearing strength N/mm ²	Notes
Directly below bearing	$\frac{1.25f_k}{\gamma_m}$	Higher bearing strengths can be achieved depending on the configuration of the concentrated load as clause 34, BS 5628
At $0.4h^*$ below bearing	$\frac{\beta t f_k}{\gamma_m}$	The concentrated load should be distributed using a 45° load spread to $0.4h$ below the bearing, where h is the clear height of the wall

Source: BS 5628: Part 1: 1992.

Masonry design to CP111

CP111 is the 'old brick code' which uses permissible stresses and has been withdrawn. Although it is now not appropriate for new construction, it can be helpful when refurbishing old buildings as the ultimate design methods used in BS 5628 are not appropriate for use with old masonry materials.

Basic compressive masonry strengths for standard format bricks (N/mm²)

Description of mortar proportions by volume	Hardening time	Basic compressive stress of unit ¹ N/mm ²									
		2.8	7.0	10.5	20.5	27.5	34.5	52.0	69.0	≥96.5 Class B Class A	
cement:lime:sand (BS 5628 mortar class)											
Dry pack – 1:0:3 (I)	7	0.28	0.70	1.05	1.65	2.05	2.50	3.50	4.55	5.85	
Cement lime – 1:1:6 (III)	14	0.28	0.70	0.95	1.30	1.60	1.85	2.50	3.10	3.80	
Cement lime – 1:2:9 (IV)	14	0.28	0.55	0.85	1.15	1.45	1.65	2.05	2.50	3.10	
Non-hydraulic lime putty with pozzolanic/cement additive – 0:1:3	14	0.21	0.49	0.70	0.95	1.15	1.40	1.70	2.05	2.40	
Hydraulic lime – 0:1:2	14	0.21	0.49	0.70	0.95	1.15	1.40	1.70	2.05	2.40	
Non-hydraulic lime mortar – 0:1:3	28 ²	0.21	0.42	0.55	0.70	0.75	0.85	1.05	1.15	1.40	

NOTES:

1. For columns or piers of cross sectional area $A < 0.2 \text{ m}^2$, the basic compressive strength should be multiplied by $\gamma = (0.7 + 1.5A)$.
2. Longer may be required if the weather is not warm and dry.

Source: CP111: 1970.

Capacity reduction factors for slenderness and eccentricity

Slenderness ratio	Slenderness reduction factor, β				
	Axially loaded	Eccentricity of loading			
		t/6	t/4	t/3	t/3 to t/2
6	1.000	1.000	1.000	1.000	1.000
8	0.950	0.930	0.920	0.910	0.885
10	0.890	0.850	0.830	0.810	0.771
12	0.840	0.780	0.750	0.720	0.657
14	0.780	0.700	0.660	0.620	0.542
16	0.730	0.630	0.580	0.530	0.428
18	0.670	0.550	0.490	0.430	0.314
20	0.620	0.480	0.410	0.340	0.200
22	0.560	0.400	0.320	0.240	–
24	0.510	0.330	0.240	–	–
26	0.450	0.250	–	–	–
27	0.430	0.220	–	–	–

Concentrated loads

Although CP111 indicates that concentrated compressive stresses up to 1.5 times the permissible compressive stresses are acceptable, it is now thought that this guidance is not conservative as it does not take account of the bearing width or position.

Therefore it is generally accepted that bearing stresses should be kept within the basic permissible stresses. For historic buildings, this typically means maximum bearing stresses of 0.42 N/mm^2 for stock bricks in traditional lime mortar or 0.7 N/mm^2 where the structure has been 'engineered', perhaps with flettons in arches or vaults.

Source: CP111: 1970.

Lintel design to BS 5977

BS 5977 sets out the method for load assessment of lintels in masonry structures for openings up to 4.5 m in single storey construction or up to 3.6 m in normal domestic two to three storey buildings. The method assumes that the masonry over an opening in a simple wall will arch over the opening. The code guidance must be applied with common sense as building elevations are rarely simple and load will be channelled down piers between openings. Typically there should be not less than 0.6 m or $0.2L$ of masonry to each side of the opening (where L is the clear span), not less than $0.6L$ of masonry above the lintel at midspan and not less than 0.6 m of masonry over the lintel supports. When working on existing buildings, the effect of new openings on existing lintels should be considered.

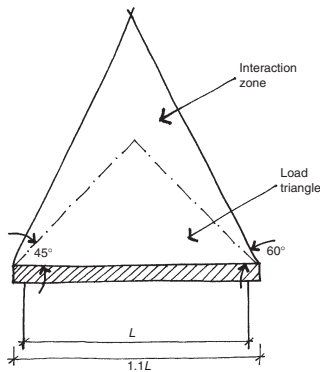

Loading assumptions:

1. The weight of the masonry in the loaded triangle is carried on the lintel – not the masonry in the zone of interaction.
2. Any point load or distributed load applied within the load triangle is dispersed at 45° and carried by the lintel.
3. Half of any point, or distributed, load applied to the masonry within the zone of interaction is carried by the lintel.

Where there are no openings above the lintel, and the loading assumptions apply, no loads outside the interaction zone need to be considered. Openings which are outside the zone of interaction, or which cut across the zone of interaction completely, need not be considered and do not add load to the lintel. However, openings which cut into (rather than across) the zone of interaction can have a significant effect on lintel loading as all the self-weight of the wall and applied loads above the line X-Y are taken into account. As for the other loads applied in the zone of interaction, they are halved and spread out at 45° from the line X-Y to give a line load on the lintel below.

All the loading conditions are illustrated in the following example:

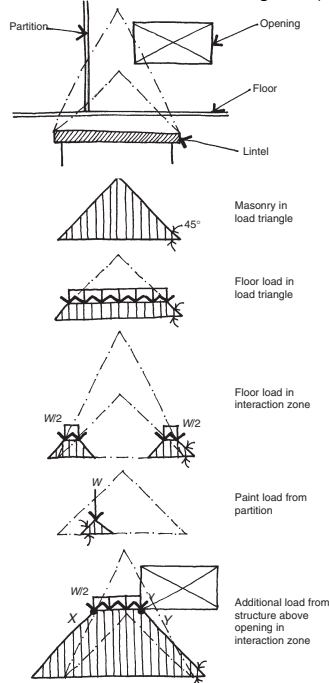

Source: BS 5977: Part 1: 1981.

Masonry accessories

Joist hangers

Joist hangers provide quick, economic and reliable timber to timber, timber to masonry and timber to steel junctions. Joist hangers should comply with BS 6178 and be galvanized for general use or stainless steel for special applications. Normally 600 mm of masonry over the hangers is required to provide restraint and ensure full load carrying capacity. Coursing adjustments should be made in the course below the course carrying the joist hanger to avoid supporting the hangers on cut blocks. The end of the joist should be packed tight to the back of the hanger, have enough bearing on the hanger and be fixed through every provided hole with 3.75×30 mm square twist sheradized nails. The back of the hanger must be tight to the wall and should not be underslung from beam supports. If the joist needs to be cut down to fit into the joist hanger, it may exceed the load capacity of the hanger. If the joist hangers are not installed to the manufacturer's instructions, they can be overloaded and cause collapse.

Straps for robustness

Masonry walls must be strapped to floors and roofs for robustness in order to allow for any out of plane forces, accidental loads and wind suction around the roof line. The traditional strap is 30×5 mm with a characteristic tensile strength of 10 kN. Straps are typically galvanized mild steel or austenitic stainless steel, fixed to three joists with four fixings and built into the masonry wall at a maximum spacing of 2 m. A typical strap can provide a restraining force of 5 kN/m depending on the security of the fixings. Compressive loads are assumed to be transferred by direct contact between the wall and floor/roof structures. Building Regulations and BS 8103: Part 1 set out recommendations for the fixing and spacing of straps.

Padstones

Used to spread the load at the bearings of steel beams on masonry walls. The plan area of the padstone is determined by the permissible concentrated bearing stress on the masonry. The depth of the padstone is based on a 45° load spread from the edges of the steel beam on the padstone until the padstone area is sufficient that the bearing stresses are within permissible values.

Proprietary pre-stressed concrete beam lintels

The following values are working loads for beam lintels which do not act compositely with the masonry above the opening manufactured by Tarmac Topfloor. Tarmac stock pre-stressed concrete lintels from 0.9 m to 3.3 m long in 0.15 m increments but can produce special lintels up to about 4.8 m long.

Maximum safe uniformly distributed load kN/m

Lintel width mm	Lintel depth mm	Fire rating hours	Clear span between supports m						
			0.9	1.5	2.1	2.7	3.3	3.9	4.5
100	100	0.5	14.7	5.6	2.8	1.6	1.0	0.7	0.4
	140	0.5	31.6	17.0	8.8	5.3	3.5	2.4	1.7
	215	0.5	50.4	31.3	18.5	11.2	7.4	5.2	3.8
140	100	0.5	30.0	11.5	5.9	3.5	2.3	1.5	1.1
	140	0.5	43.6	23.2	12.0	7.2	4.7	3.3	2.4
	215	0.5	68.0	42.2	26.0	15.8	10.5	7.3	5.4
150	100	1.0	30.8	11.8	6.0	3.6	2.3	1.6	1.1
	140	1.0	46.1	23.8	12.4	7.4	4.9	3.4	2.4
	215	1.0	71.8	44.5	26.7	16.2	10.7	7.5	5.5
190	100	1.0	40.2	15.4	7.9	4.7	3.0	2.1	1.4
	140	1.0	58.2	29.46	15.2	9.2	6.0	4.1	3.0
	215	1.0	93.6	58.1	34.0	20.6	13.7	9.6	7.0
215	100	1.0	42.2	16.2	8.3	4.95	3.1	2.1	1.5
	140	1.0	66.4	35.3	18.3	11.06	7.2	5.0	3.6
	215	1.0	105.5	65.5	40.3	24.4	16.2	11.4	8.3

Source: Tarmac Topfloor (2002). Note that this information is subject to change at any time. Consult the latest Tarmac literature for up to date information.

Profiled steel lintels

Profiled galvanized steel lintels are particularly useful for cavity wall construction, as they can be formed to support both leaves and incorporate insulation. Profiled steel lintels are supplied to suit cavity widths from 50 mm to 165 mm, single leaf walls, standard and heavy duty loading conditions, wide inner or outer leaves and timber construction. Special lintels are also available for corners and arches. The following lintels are selected from the range produced by I.G. Ltd.

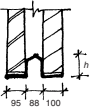
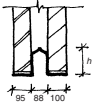
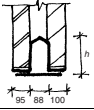
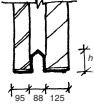
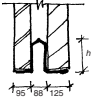
Lintel reference	Ext. leaf mm	Cavity mm	Int. leaf mm	Height mm	Available lengths mm	Gauge mm	Weight kg/m	I_{xx} cm ⁴	Z_{xx} cm ³	Total working load kN	Allowable moment kNm
L1/S 100 	102	90-105	100	99	0.6-1.5	2.5	8.6	135.6	20.70	10	3.3
				124	1.6-1.8	2.5	9.6	241.2	30.19	16	4.9
				136	1.9-2.1	2.5	10.1	307.9	35.41	15	5.7
				149	2.2-2.4	2.8	11.8	430.2	45.79	17	7.4
				174	2.5-3.0	2.8	12.9	637.6	59.17	24	9.6
				204	3.1-3.6	3.0	15.3	1022.4	82.39	24	13.3
				207 ¹	3.7-4.8	3.0	18.2	1164.0	87.39	24	14.2
L1/HD 100 	102	90-105	100	124	0.6-1.5	2.8	10.7	269.8	33.76	24	5.4
				127 ¹	1.6-1.8	2.8	13.7	310.2	35.81	30	5.8
				152 ¹	1.9-2.1	2.8	14.8	494.4	48.61	35	7.8
				177 ¹	2.2-2.4	2.8	15.9	732.0	62.87	35	10.2
				177 ¹	2.5-2.7	3.0	16.8	778.6	67.13	40	10.9
				207 ¹	2.8-3.0	3.0	18.2	1164.0	87.39	40	14.2
				207 ¹	3.1-3.6	3.0	18.2	1164.0	87.39	36	14.2
207 ¹	3.7-4.2	3.0	18.2	1164.0	87.39	30	14.2				
L1/XHD 100 	102	90-105	100	152 ¹	0.6-1.5	3.0	15.6	525.8	51.90	45	8.4
				177 ¹	1.6-2.1	3.0	16.8	778.6	67.13	45	10.9
				207 ¹	2.2-2.4	3.0	18.2	1164.0	87.39	45	14.2
				207 ¹	2.5-2.7	3.0	18.2	1164.0	87.39	40	14.2
L1/S WIL 100 	102	90-105	140	87	0.6-1.2	2.5	8.6	99.5	16.71	12	2.7
				112	1.3-1.5	2.5	9.6	191.6	25.70	12	4.1
				124	1.6-1.8	2.5	10.1	251.4	30.70	14	4.9
				136	1.9-2.1	2.8	11.8	359.0	40.29	17	6.5
				161	2.2-2.4	2.8	12.9	550.2	53.25	17	8.6
				161	2.5-2.7	3.0	13.9	589.1	57.01	19	9.2
				164 ¹	2.8-3.6	3.0	16.8	662.9	59.97	24	9.7
164 ¹	3.7-4.2	3.0	18.2	1020.5	79.61	24	12.9				
L1/HD WIL 100 	102	90-105	140	111	0.6-1.2	2.8	10.7	214.3	28.74	18	4.6
				136	1.3-1.5	3.0	12.7	384.4	43.13	24	7.0
				139 ¹	1.6-1.8	3.0	15.6	432.6	45.32	28	7.3
				164 ¹	1.9-2.1	2.8	15.9	625.4	56.39	32	9.1
				164 ¹	2.2-2.4	3.0	16.8	662.9	59.97	34	9.7
				194 ¹	2.5-2.7	3.0	18.2	1020.5	79.61	34	12.9

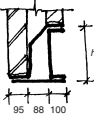
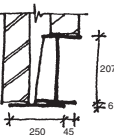
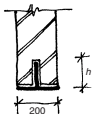
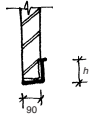
L5/100² 	102 90-105 125 max	153 0.6-1.8 2.5 16.2 228 1.9-2.4 2.5 19.2 228 2.5-3.9 3.0 22.4 228 4.0-4.8 3.0 22.4 228 0.6-4.8 3.0 23.1	811 89.78 1952 139.55 2348 167.51 2348 167.51 2448 183.85	36 14.5 48 22.6 50 27.2 38 27.2 45 29.8
L6/100³ 	102 90-105 125 max	213 1.2-3.0 - 43.9 213 3.1-4.8 - 43.9 213 5.1 - 43.9 213 5.4 - 43.9 213 5.7 - 43.9 213 6.0 - 43.9 213 6.3 - 43.9 213 6.6 - 43.9	4088 313.20 4630 328.79 4630 328.79 4630 328.79 4630 328.79 4630 328.79 4630 328.79 4630 328.79	95 56.3 83 53.4 75 53.4 65 53.4 58 53.4 53 53.4 47 53.4 43 53.4
L9 	200-215	55 0.6-1.5 2.5 5.6 55 1.6-1.8 3.0 6.8 100 1.9-2.7 3.0 8.5	19 4.39 24 5.48 102 14.94	6 0.7 6 0.8 10 2.4
L10 	102	60 0.6-1.2 3.0 3.5 110 1.3-1.8 3.0 4.7 210 1.9-2.7 2.8 6.5	17 3.67 68 9.29 396 30.32	4 0.5 8 1.5 10 4.9

Profiled steel lintels – continued

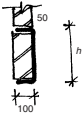
Lintel reference	Ext. leaf mm	Cavity mm	Int. leaf mm	Height mm	Available lengths mm	Gauge mm	Weight kg/m	I_{xx} cm ⁴	Z_{xx} cm ³	Total working load kN	Allowable moment kNm
L11 	102			150	0.6–1.8	2.5	5.6	292	34.08	16	5.5
				225	1.9–2.4	2.5	7.1	754	59.96	20	9.7
				225	2.5–3.0	3.0	8.5	920	73.15	22	11.8

NOTES:

1. Indicates that a continuous bottom plate is added to lintel.
2. L5 and L11 lintels are designed assuming composite action with the masonry over the lintel.
3. L6 lintels are made with 203 x 133UB30 supporting the inner leaf.
4. The L1/S lintel is also available as L1/S 110 for cavities 110–125 mm, L1/S 130 for 130–145 mm and L1/S 150 for 150–165 mm.
5. IG can provide details for wide inner leaf lintels for cavities greater than 100 mm on request.
6. Loads in tables are unfactored. A lintel should not exceed in a max. deflection of $L/325$ when subject to the safe working load.

Source: IG limited (2003).

8

Reinforced Concrete

The Romans are thought to have been the first to use the binding properties of volcanic ash in mass concrete structures. The art of making concrete was then lost until Portland Cement was discovered in 1824 by Joseph Aspedin from Leeds. His work was developed by two Frenchmen, Monier and Lambot, who began experimenting with reinforcement. Deformed bars were developed in America in the 1870s, and the use of reinforced concrete has developed worldwide since 1900–1910. Concrete consists of a paste of aggregate, cement and water which can be reinforced with steel bars, or occasionally fibres, to enhance its flexural strength. Concrete constituents are as follows:

Cement Limestone and clay fired to temperatures of about 1400°C and ground to a powder. Grey is the standard colour but white can be used to change the mix appearance. The cement content of a mix affects the strength and finished surface appearance.

Aggregate Coarse aggregate (10 to 20 mm) and sand make up about 75% of the mix volume. Coarse aggregate can be natural dense stone or lightweight furnace by-products.

Water Water is added to create the cement paste which coats the aggregate. The water/cement ratio must be carefully controlled as the addition of water to a mix will increase workability and shrinkage, but will reduce strength if cement is not added.

Reinforcement Reinforcement normally consists of deformed steel bars. Traditionally the main bars were typically high yield steel ($f_y = 460 \text{ N/mm}^2$) and the links mild steel ($f_y = 250 \text{ N/mm}^2$). However, the new standards on bar bending now allow small diameter high yield bars to be bent to the same small radii as mild steel bars. This may mean that the use of mild steel links will reduce. The bars can be loose, straight or shaped, or as high yield welded mesh. Less commonly steel, plastic or glass fibres can be added (1 to 2% by volume) instead of bars to improve impact and cracking resistance, but this is generally only used for ground bearing slabs.

Admixtures Workability, durability and setting time can be affected by the use of admixtures.

Formwork Generally designed by the contractor as part of the temporary works, this is the steel, timber or plastic mould used to keep the liquid concrete in place until it has hardened. Formwork can account for up to half the cost of a concrete structure and should be kept simple and standardized where possible.

Summary of material properties

Density 17 to 24 kN/m³ depending on the density of the chosen aggregate.

Compressive strength Design strengths have a good range. $F_{cu} = 7$ to 60 N/mm².

Tensile strength Poor at about 8 to 15% of F_{cu} . Reinforcement provides flexural strength.

Modulus of elasticity This varies with the mix design strength, reinforcement content and age. Typical short-term (28 days) values are: 24 to 32 kN/mm². Long-term values are about 30 to 50% of the short-term values.

Linear coefficient of thermal expansion 8 to 12 $\times 10^{-6}$ °C

Shrinkage As water is lost in the chemical hydration reaction with the cement, the concrete section will shrink. The amount of shrinkage depends on the water content, aggregate properties and section geometry. Normally, a long-term shrinkage strain of 0.03% can be assumed, of which 90% occurs in the first year.

Creep Irreversible plastic flow will occur under sustained compressive loads. The amount depends on the temperature, relative humidity, applied stress, loading period, strength of concrete, allowed curing time and size of element. It can be assumed that about 40% and 80% of the final creep occurs in one month and 30 months respectively. The final (30 year) creep value is estimated from $\sigma\phi/E$, where σ is the applied stress, E is the modulus of elasticity of the concrete at the age of loading and ϕ is the creep factor which varies between about 1.0 and 3.2 for UK concrete loaded at 28 days.

Concrete mixes

Concrete mix design is not an absolute science. The process is generally iterative, based on an initial guess at the optimum mix constituents, followed by testing and mix adjustments on a trial-and-error basis.

There are different ways to specify concrete. A Prescribed Mix is where the purchaser specifies the mix proportions and is responsible for ensuring (by testing) that these proportions produce a suitable mix. A Designed Mix is where the engineer specifies the required performance, the concrete producer selects the mix proportions and concrete cubes are tested in parallel with the construction to check the mix compliance and consistency. Grades of Designed Mixes are prefixed by C. Special Proprietary Mixes such as self-compacting or waterproof concrete can also be specified, such as Pudlo or Caltite.

The majority of the concrete in the UK is specified on the basis of strength, workability and durability as a designated mix to BS 5328. This means that the ready mix companies must operate third party accredited quality assurance (to BS EN ISO 9001), which substantially reduces the number of concrete cubes which need to be tested. Grades of Designated mixes are prefixed by GEN, FND or RC depending on their proposed use. BS 5328 is soon to be superseded by BS EN 206 and BS 8500 which will make specification more difficult.

Designated concrete mixes to BS 5328: Part 1

Designated mix	Compressive strength N/mm ²	Typical application	Min cement content kg/m ³	Max free water/cement ratio	Typical slump mm
GEN 0	7.5	Kerb bedding and backing	120	n/a	nominal 10
GEN 1	10	Blinding and mass concrete fill	175	n/a	75
		Drainage works	175	n/a	10–50
		Oversite below suspended slabs	175	n/a	75
GEN 3	20	Mass concrete foundations	175	n/a	75
		Trench fill foundations	175	n/a	125
FND 2, 3, 4 or 4A	35	Foundations in sulphate conditions: 2, 3, 4 or 4A	Varies	0.6	75
RC 30	30	Reinforced concrete	275	0.65	50–100
RC 35	35		300	0.60	50–100
RC 40	40		325	0.55	50–100
RC 50	50		400	0.45	50–100

Source: BS 5328: Part 1: 1997: Table 13 adapted.

Traditional prescribed mix proportions

Concrete was traditionally specified on the basis of prescribed volume proportions of cement to fine and coarse aggregates. This method cannot allow for variability in the mix constituents, and as a result mix strengths can vary widely. This variability means that prescribed mixes batched by volume are rarely used for anything other than small works where the concrete does not need to be of a particularly high quality.

Typical volume batching ratios and the probable strengths achieved (with a slump of 50 mm to 75 mm) are:

Typical prescribed mix volume batching proportions Cement : sand : 20 mm aggregate	Probable characteristic crushing strength, f_{cu} N/mm ²
1:1.5:3	40
1:2:4	30
1:3:6	20

Concrete cube testing for strength of designed mixes

Concrete cube tests should be taken to check compliance of the mix with the design and specification. The amount of testing will depend on how the mix has been designed or specified. If the concrete is a designed mix from a ready mix plant BS 5328 gives the following minimum rates for sampling:

1 sample per	Maximum quantity of concrete at risk under any one decision	Examples of applicable structures
10 m ³ or 10 batches 20 m ³ or 20 batches 50 m ³ or 50 batches	40 m ³ 80 m ³ 200 m ³	Masts, columns, cantilevers Beams, slabs, bridges, decks Solid rafts, breakwaters

At least one 'sample' should be taken, for each type of concrete mix on the day it is placed, prepared to the requirements of BS 1881. If the above table is not used, 60 m³ should be the maximum quantity of concrete represented by four consecutive test results. Higher rates of sampling should be adopted for critical elements.

A sample consists of two concrete cubes for each test result. Where results are required for 7 and 28 day strengths, four cubes should be prepared. The concrete cubes are normally cured under water at a minimum of 20°C ± 2°C. If the cubes are not cured at this temperature, their crushing strength can be seriously reduced.

Cube results must be assessed for validity using the following rules for 20 N/mm² concrete or above:

- A cube test result is said to be the mean of the strength of two cube tests. Any individual test result should not be more than 3 N/mm² below the specified characteristic compressive strength.
- When the difference between the two cube tests (i.e. four cubes) divided by their mean is greater than 15% the cubes are said to be too variable in strength to provide a valid result.
- If a group of test results consists of four consecutive cube results (i.e. eight cubes). The mean of the group of test results should be at least 3 N/mm² above the specified characteristic compressive strength.

Separate tests are required to establish the conformity of the mix on the basis of workability, durability, etc.

Source: BS 5328: Part 1: 1997.

Durability and fire resistance

Durability exposure conditions to BS 8110

Mild Concrete surfaces protected against weather or aggressive conditions.

Moderate Exposed surfaces but sheltered from severe rain or freezing while wet. Surfaces continually under non-aggressive water or soil. Surfaces subject to condensation.

Severe Surfaces exposed to severe rain, alternate wetting and drying or occasional freezing or severe condensation.

Very severe Surfaces occasionally exposed to sea water spray or de-icing salts. Surfaces exposed to corrosive fumes or severe freezing conditions while wet.

Most severe Surfaces frequently exposed to seawater spray or de-icing salts. Concrete in seawater tidal zone down to 1 m below lowest water.

In severe exposure conditions (e.g. marine structures, foundations) and/or for exposed architectural precast units stainless steel reinforcement can be used to improve corrosion resistance and prevent spalling and staining. Austenitic is the most common type of stainless steel used in reinforcing bars.

Concrete cover to meet durability exposure conditions

Exposure condition	Nominal cover to all reinforcement mm				
Mild	25	20	20	20	20
Moderate	–	35	30	25	20
Severe	–	–	40	30	25
Very severe	–	–	50	40	30
Most severe	–	–	–	–	50
Maximum free water/ cement ratio	0.65	0.60	0.55	0.50	0.45
Minimum cement content kg/m³	275	300	325	350	400
Lowest grade of concrete	C30	C35	C40	C45	C50

Source: BS 8110: Part 1: 1997.

Minimum dimensions and cover for fire resistance periods

Member	Requirements	Fire rating hours					
		0.5	1.0	1.5	2.0	3.0	4.0
Columns fully exposed to fire	Minimum column width Cover*	150 20	200 20	250 20	300 25	400 25	450 25
Walls (0.4 to 1% steel)	Minimum wall thickness Cover*	100 20	120 20	140 20	160 25	200 25	240 25
Beams	Minimum beam width Cover for simply supported* Cover for continuous*	200 20 20	200 20 20	200 20 20	200 30 40	240 40 60	280 50 70
Slabs with plain soffits	Minimum slab thickness Cover for simply supported* Cover for continuous*	75 20 20	95 20 20	110 25 20	125 35 25	150 45 35	170 55 45
Ribbed slabs (open soffit and no stirrups)	Minimum top slab thickness Minimum rib width Cover for simply supported* Cover for continuous*	75 125 20 20	95 125 20 20	110 125 35 20	125 125 45 35	150 150 55 45	170 175 65 55

* Cover required to all reinforcement including links. If cover >35 mm special detailing is required to reduce the risk of spalling.

Source: BS 8110: Part 1: 1997.

Preliminary sizing of concrete elements

Typical span/depth ratios

Element	Typical spans m	Overall depth or thickness		
		Simply supported	Continuous	Cantilever
One way spanning slabs	5–6	L/22–30	L/28–36	L/7–10
Two way spanning slabs	6–11	L/24–35	L/34–40	–
Flat slabs	4–8	L/27	L/36	L/7–10
Close centre ribbed slabs (ribs at 600 mm c/c)	6–14	L/23	L/31	L/9
Coffered slabs (ribs at 900–1500 mm c/c)	8–14	L/15–20	L/18–24	L/7
Post tensioned flat slabs	9–10	L/35–40	L/38–45	L/10–12
Rectangular beams (width >250 mm)	3–10	L/12	L/15	L/6
Flanged beams	5–15	L/10	L/12	L/6
Columns	2.5–8	H/10–20	H/10–20	H/10
Walls	2–4	H/30–35	H/45	H/15–18
Retaining walls	2–8	–	–	H/10–14

NOTE:

125 mm is normally the minimum concrete floor thickness for fire resistance.

Preliminary sizing

Beams Although the span/depth ratios are a good indication, beams tend to need more depth to fit sufficient reinforcement into the section in order to satisfy deflection requirements. Check the detailing early – especially for clashes with steel at column/beam junctions. The shear stress should be limited to 2 N/mm^2 for preliminary design.

Solid slabs Two way spanning slabs are normally about 90% of the thickness of one way spanning slabs.

Profiled slabs Obtain copies of proprietary mould profiles to minimize shuttering costs. The shear stress in ribs should be limited to 0.6 N/mm^2 for preliminary design.

Columns A plain concrete section with no reinforcement can take an axial stress of about $0.45F_{cu}$. The minimum column dimensions for a stocky braced column = clear column height/17.5.

A simple allowance for moment transfer in the continuous junction between slab and column can be made by factoring up the load from the floor immediately above the column being considered (by 1.25 for interior, 1.50 for edge and 2.00 for corner columns). The column design load is this factored load plus any other column loads.

For stocky columns, the column area (A_c) can be estimated by: $A_c = N/15$, $N/18$ or $N/21$ for columns in RC35 concrete containing 1%, 2% or 3% high yield steel respectively.

Reinforcement

The ultimate design strength is $f_y = 250 \text{ N/mm}^2$ for mild steel and $f_y = 460 \text{ N/mm}^2$ high yield reinforcement.

Weight of reinforcement bars by diameter (kg/m)

6 mm	8 mm	10 mm	12 mm	16 mm	20 mm	25 mm	32 mm	40 mm
0.222	0.395	0.616	0.888	1.579	2.466	3.854	6.313	9.864

Reinforcement area (mm^2) for groups of bars

Number of bars	Bar diameter mm								
	6	8	10	12	16	20	25	32	40
1	28	50	79	113	201	314	491	804	1257
2	57	101	157	226	402	628	982	1608	2513
3	85	151	236	339	603	942	1473	2413	3770
4	113	201	314	452	804	1257	1963	3217	5027
5	141	251	393	565	1005	1571	2454	4021	6283
6	170	302	471	679	1206	1885	2945	4825	7540
7	198	352	550	792	1407	2199	3436	5630	8796
8	226	402	628	905	1608	2513	3927	6434	10053
9	254	452	707	1018	1810	2827	4418	7238	11310

Reinforcement area (mm^2/m) for different bar spacing

Spacing mm	Bar diameter mm								
	6	8	10	12	16	20	25	32	40
50	565	1005	1571	2262	4021	6283	9817	–	–
75	377	670	1047	1508	2681	4189	6545	10723	–
100	283	503	785	1131	2011	3142	4909	8042	12566
125	226	402	628	905	1608	2513	3927	6434	10053
150	188	335	524	754	1340	2094	3272	5362	8378
175	162	287	449	646	1149	1795	2805	4596	7181
200	141	251	393	565	1005	1571	2454	4021	6283
225	126	223	349	503	894	1396	2182	3574	5585
250	113	201	314	452	804	1257	1963	3217	5027

Reinforcement mesh to BS 4483

Fabric reference	Longitudinal wires			Cross wires			Mass kg/m ²
	Diameter mm	Pitch mm	Area mm ² /m	Diameter mm	Pitch mm	Area mm ² /m	
Square mesh – High tensile steel							
A393	10	200	393	10	200	393	6.16
A252	8	200	252	8	200	252	3.95
A193	7	200	193	7	200	193	3.02
A142	6	200	142	6	200	142	2.22
A98	5	200	98	5	200	98	1.54
Structural mesh – High tensile steel							
B131	12	100	1131	8	200	252	10.9
B785	10	100	785	8	200	252	8.14
B503	8	100	503	8	200	252	5.93
B385	7	100	385	7	200	193	4.53
B283	6	100	283	7	200	193	3.73
B196	5	100	196	7	200	193	3.05
Long mesh – High tensile steel							
C785	10	100	785	6	400	70.8	6.72
C636	9	100	636	6	400	70.8	5.55
C503	8	100	503	5	400	49	4.34
C385	7	100	385	5	400	49	3.41
C283	6	100	283	5	400	49	2.61
Wrapping mesh – Mild steel							
D98	5	200	98	5	200	98	1.54
D49	2.5	100	49	2.5	100	49	0.77
Stock sheet size	Longitudinal wires			Cross wires			Sheet area
	Length 4.8 m			Width 2.4 m			

Source: BS 4486: 1985.

Shear link reinforcement areas

Shear link area, A_{sv} mm ²		Shear link area/link bar spacing, A_{sv}/S_v mm ² /mm										
No. of link legs	Link diameter mm	Link spacing, S_v mm										
	6 8 10 12	100	125	150	175	200	225	250	275	300		
2	56	0.560	0.448	0.373	0.320	0.280	0.249	0.224	0.204	0.187		
	100	1.000	0.800	0.667	0.571	0.500	0.444	0.400	0.364	0.333		
	158	1.580	1.264	1.053	0.903	0.790	0.702	0.632	0.575	0.527		
	226	2.260	1.808	1.507	1.291	1.130	1.004	0.904	0.822	0.753		
3	84	0.840	0.672	0.560	0.480	0.420	0.373	0.336	0.305	0.280		
	150	1.500	1.200	1.000	0.857	0.750	0.667	0.600	0.545	0.500		
	237	2.370	1.896	1.580	1.354	1.185	1.053	0.948	0.862	0.790		
	339	3.390	2.712	2.260	1.937	1.695	1.507	1.356	1.233	1.130		
4	112	1.120	0.896	0.747	0.640	0.560	0.498	0.448	0.407	0.373		
	200	2.000	1.600	1.333	1.143	1.000	0.889	0.800	0.727	0.667		
	316	3.160	2.528	2.107	1.806	1.580	1.404	1.264	1.149	1.053		
	452	4.520	3.616	3.013	2.583	2.260	2.009	1.808	1.644	1.507		
6	168	1.680	1.344	1.120	0.960	0.840	0.747	0.672	0.611	0.560		
	300	3.000	2.400	2.000	1.714	1.500	1.333	1.200	1.091	1.000		
	474	4.740	3.792	3.160	2.709	2.370	2.107	1.896	1.724	1.580		
	678	6.780	5.424	4.520	3.874	3.390	3.013	2.712	2.465	2.260		

Concrete design to BS 8110

Partial safety factors for ultimate limit state

Load combination	Load type					
	Dead		Live		Earth	Wind
	Adverse	Beneficial	Adverse	Beneficial	and water pressures	
Dead and imposed (and earth and water pressure)	1.4	1.0	1.6	0.0	1.4	–
Dead and wind (and earth and water pressure)	1.4	1.0	–	–	1.4	1.4
Dead and wind and imposed (and earth and water pressure)	1.2	1.2	1.2	1.2	1.2	1.2

Effective depth

Effective depth, d , is the depth from compression face of section to the centre of area of the main reinforcement group allowing for layering, links and concrete cover.

Design of beams

Design moments and shears in beams with more than three spans

	At outer support	Near middle of end span	At first interior support	At middle of interior span	At interior supports
Moment	0	$\frac{WL}{11}$	$-\frac{WL}{9}$	$\frac{WL}{14}$	$-\frac{WL}{12.5}$
Shear	$\frac{W}{2}$	–	$\frac{W}{16}$	–	$\frac{5W}{9}$

Source: BS 8110: Part 1: 1997.

Ultimate moment capacity of beam section

$M_u = 0.156F_{cu}bd^2$ where there is less than 10% moment redistribution.

Factors for lever arm (z/d) and neutral axis (x/d) depth

$k = \frac{M}{F_{cu}bd^2}$	0.043	0.050	0.070	0.090	0.110	0.130	0.145	0.156
z/d	0.950	0.941	0.915	0.887	0.857	0.825	0.798	0.777
x/d	0.13	0.15	0.19	0.25	0.32	0.39	0.45	0.50

Where z = lever arm and x = neutral axis depth.

Area of tension reinforcement for rectangular beams

If the applied moment is less than M_u , then the area of tension reinforcement, $A_{s,required} = M/[0.95(\frac{z}{d})f_y d]$.

If the applied moment is greater than M_u , then the area of compression steel is

$A'_{s,required} = (K - 0.156) F_{cu}bd^2/[0.95f_y(d - d')]$ and the area of tension reinforcement is,

$A_{s,required} = 0.156F_{cu}bd^2/[0.95f_y z] + A'_s$ if redistribution is less than 10%.

Equivalent breadth and depth of neutral axis for flanged beams

Flanged beams	Simply supported	Continuous	Cantilever
T beam	$b_w + L/5$	$b_w + L/7$	b_w
L beam	$b_w + L/10$	$b_w + L/13$	b_w

Where b_w = breadth of web, L = actual flange width or beam spacing, h_f is the depth of the flange.

Calculate k using b_w . From k , calculate $0.9x$ from the tabulated values of the neutral axis depth, x/d .

If $0.9x \leq h_f$, the neutral axis is in the beam flange and steel areas can be calculated as rectangular beams.

If $0.9x > h_f$, the neutral axis is in the beam web and steel areas can be calculated as BS 8110: clause 3.4.4.5.

Source: BS 8110: Part 1: 1997.

Shear stresses in beams

The applied shear stress is $\nu = V/b_v d$.

Shear capacity of concrete

The shear capacity of concrete, v_c , relates to the section size, effective depth and percentage reinforcement.

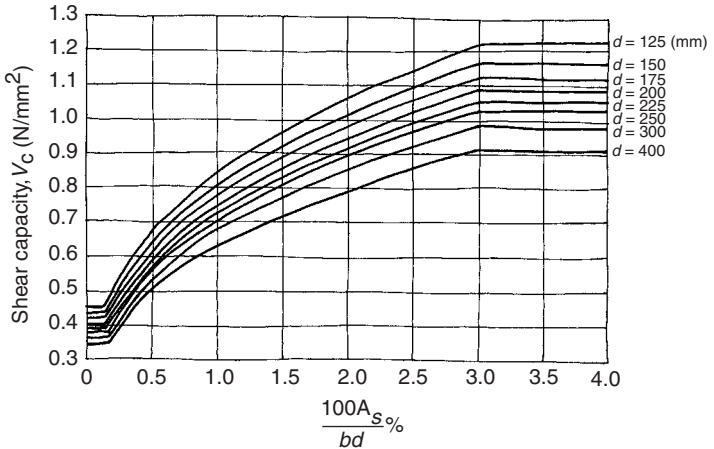

Form and area of shear reinforcement in beams

Value of applied shear stress ν (N/mm^2)	Form of shear reinforcement to be provided	Area of shear reinforcement to be provided (mm^2)
$\nu < 0.5v_c$ throughout beam	Minimum links should normally be provided other than in elements of minor importance such as lintels, etc.	Suggested minimum in $f_{yv} = 250 \text{ N/mm}^2$ $A_{sv} > \frac{0.2b_v d}{100}$
$0.5v_c < \nu < (0.4 + v_c)$	Minimum links for whole length of beam to provide a shear resistance of 0.4 N/mm^2	$A_{sv} > \frac{0.4b_v d}{0.95f_{yv}}$
$(0.4 + v_c) < \nu < 0.8\sqrt{F_{cu}}$ or 5 N/mm^2	Links provided for whole length of beam at no more than $0.75d$ spacing along the span. No tension bar should be more than 150 mm from a vertical shear link leg*	$A_{sv} > \frac{b_v S_v (\nu - v_c)}{0.95f_{yv}}$

*Bent-up bars can be used in combination with links as long as no more than 50% of the shear resistance comes from the bent-up bars as set out in BS 8110: clause 3.4.5.6.

Source: BS 8110: Part 1: 1997.

Design of solid slabs

Solid slabs are supported on walls or beams.

With simple supports the applied moment is about $M = w_l l_y / 24$ allowing for bending in two directions, where l_x and l_y can be different span lengths.

Design moments and shear forces for a one way spanning continuous solid slab

	End support/slab connection				At first interior support	At middle of interior span	At interior supports
	Simple support		Continuous				
	At outer support	Near middle of end span	At outer support	Near middle of end span			
Moment	0	$\frac{WL}{11.5}$	$-\frac{WL}{25}$	$\frac{WL}{13}$	$-\frac{WL}{11.5}$	$\frac{WL}{15.5}$	$-\frac{WL}{15.5}$
Shear	$\frac{W}{2.5}$	–	$\frac{6W}{13}$	–	$\frac{3W}{5}$	–	$\frac{W}{2}$

Where W is the load on one span and L is the length of one span.

Design moments for a two way spanning continuous solid slab

Where $l_y/l_x \leq 1.5$ the following formulae and coefficients can be used to calculate moments in orthogonal directions $M_x = \beta_x W l_x$ and $M_y = \beta_y W l_y$ for the given edge conditions:

Type of panel	Moments considered*	Coefficient β_x for short span l_x			Coefficient β_y for long span l_y
		$\frac{l_y}{l_x} = 1.0$	$\frac{l_y}{l_x} = 1.2$	$\frac{l_y}{l_x} = 1.5$	
Interior panel	Continuous edge	$-\frac{1}{32}$	$-\frac{1}{23}$	$-\frac{1}{19}$	$-\frac{1}{31}$
	Midspan	$\frac{1}{41}$	$\frac{1}{29}$	$\frac{1}{25}$	$\frac{1}{41}$
One short edge discontinuous	Continuous edge	$-\frac{1}{26}$	$-\frac{1}{20}$	$-\frac{1}{17}$	$-\frac{1}{27}$
	Midspan	$\frac{1}{34}$	$\frac{1}{26}$	$\frac{1}{23}$	$\frac{1}{35}$
One long edge discontinuous	Continuous edge	$-\frac{1}{26}$	$-\frac{1}{17}$	$-\frac{1}{13}$	$-\frac{1}{27}$
	Midspan	$\frac{1}{33}$	$\frac{1}{22}$	$\frac{1}{18}$	$\frac{1}{35}$
Two adjacent edges discontinuous	Continuous edge	$-\frac{1}{21}$	$-\frac{1}{15}$	$-\frac{1}{12}$	$-\frac{1}{22}$
	Midspan	$\frac{1}{27}$	$\frac{1}{20}$	$\frac{1}{17}$	$\frac{1}{29}$

* These moments apply to the full width of the slab in each direction. The area of reinforcement to be provided top and bottom, both ways, at corners where the slab is not continuous = 75% of the reinforcement for the short span, across a width $l_x/5$ both ways.

Form and area of shear reinforcement in solid slabs

The allowable shear stress, v_c , is the same as that calculated for beams, but the slab section should be sized to avoid shear reinforcement. If required, Table 3.16 in BS 8110 sets out the reinforcement requirements.

Source: BS 8110: Part 1: 1997.

Design of flat slabs

Flat slabs are solid slabs on concrete which sit on points or columns instead of linear wall or beam supports. Slab depth should be selected to satisfy deflection requirements and to resist shear around the column supports. Any recognized method of elastic analysis can be used, but BS 8110 suggests that the slabs be split into bay-wide subframes with columns or sections of columns projecting above and below the slab.

Simplified bending moment analysis in flat slabs

A simplified approach is permitted by BS 8110 which allows moments to be calculated on the basis of the values for one way spanning solid slabs on continuous supports less the value of $0.15W/h_c$ where $h_c = \sqrt{4A_{col}/\pi}$ and A_{col} = column area. Alternatively, the following preliminary moments for regular grid with a minimum of three bays can be used for feasibility or preliminary design purposes only:

Preliminary target moments and forces for flat slab design

	End support/slab connection				At first interior support	At middle of interior span	At interior supports
	Simple support		Continuous				
	At outer support	Near middle of end span	At outer support	Near middle of end span			
Column strip moments	0	$\frac{WL^2}{11}$	$-\frac{WL^2}{20}$	$\frac{WL^2}{10}$	$-\frac{2WL^2}{13}$	$\frac{WL^2}{11}$	$-\frac{2WL^2}{15}$
Middle strip moments	0	$\frac{WL^2}{11}$	$-\frac{WL^2}{20}$	$\frac{WL^2}{10}$	$-\frac{WL^2}{20}$	$\frac{WL^2}{11}$	$-\frac{WL^2}{20}$

W is a UDL in kN/m^2 , L is the length of one span and M is in kNm/m width of slab.

Moment transfer between the slab and exterior columns is limited to $M_{t\max} = 0.15F_{cu}b_e d^2$ where b_e depends on the slab to column connection as given in Figure 3.13 in BS 8110. Subframe moments may need to be adjusted to keep the assumed moment transfer within the value of $M_{t\max}$.

Distribution of bending moments in flat slabs

The subframes used in the analysis are further split into middle and column strips. Loads are more concentrated on the column strips. Typically, for hogging (negative) moments, 75% of the total subframe design moment will be distributed to the column strip. For sagging (positive) moments, 55% of the total subframe design moment will be distributed to the column strip. Special provision must be made for holes in panels and panels with marginal beams or supporting walls. BS 8110 suggests that where $l_y/l_x \leq 2.0$, column strips are normally $l_x/2$ wide centred on the grid. The slab should be detailed so that 66 per cent of the support reinforcement is located in the width $l_x/4$ centred over the column.

Punching shear forces in flat slabs

The critical shear case for flat slabs is punching shear around the column heads. The basic shear, V , is equal to the full design load over the area supported by the column which must be converted to effective shear forces to account for moment transfer between the slab and columns.

For slabs with equal spans, the effective shears are: $V_{\text{eff}} = 1.15V$ for internal columns, $V_{\text{eff}} = 1.25V$ for corner columns and $V_{\text{eff}} = 1.25V$ for edge columns for moments parallel to the slab edge or $V_{\text{eff}} = 1.4V$ edge columns for moments perpendicular to the slab edge.

Punching shear checks in flat slabs

The shear stress at the column face should be checked: $\nu_o = V_{\text{eff}}/U_o d$ (where U_o is the column perimeter in contact with the slab). This should be less than the lesser of $0.8 \sqrt{F_{cu}}$ or 5 N/mm^2 .

Perimeters radiating out from the column should then be checked: $\nu_i = V_{\text{eff}}/U_i d$ where U_i is the perimeter of solid slab spaced off the column. The first perimeter checked ($i = 1$) is spaced $1.5d$ from the column face with subsequent shear perimeters spaced at $0.75d$ intervals. Successive perimeters are checked until the applied shear stress is less than the allowable stress, ν_c . BS 8110: clause 3.7.76 sets out the detailing procedure and gives rules for the sharing of shear reinforcement between perimeters.

The position of the column relative to holes and free edges must be taken into account when calculating the perimeter of the slab/column junction available to resist the shear force.

Stiffness and deflection

BS 8110 gives basic span/depth ratios which limit the total deflection to span/250 and live load and creep deflections to the lesser of span/500 or 20 mm, for spans up to 10 m.

Basic span/depth ratios for beams

Support conditions	Rectangular sections $\frac{b_w}{b} = 1.0$	Flanged section $\frac{b_w}{b} \leq 0.3$
Cantilever	7	5.6
Simply supported	20	16.0
Continuous	26	20.8

For values of $b_w/b > 0.3$ linear interpolation between the flanged and rectangular values is permitted.

Allowable span/depth ratio

Allowable span/depth = $F_1 \times F_2 \times F_3 \times F_4 \times$ Basic span/depth ratio

Where:

F_1 modification factor to reduce deflections in beams with spans over 10 m.
 $F_1 = 10/\text{span}$, where $F_1 < 1.0$

F_2 modification for tension reinforcement

F_3 modification for compression reinforcement

F_4 modification for stair waists where the staircase occupies at least 60% of the span and there is no stringer beam, $F_4 = 1.15$

The service stress in the bars, $f_s = \frac{2f_y A_s \text{ required}}{3A_s \text{ provided}}$

Source: BS 8110: Part 1: 1997.

Modification factor for tension reinforcement

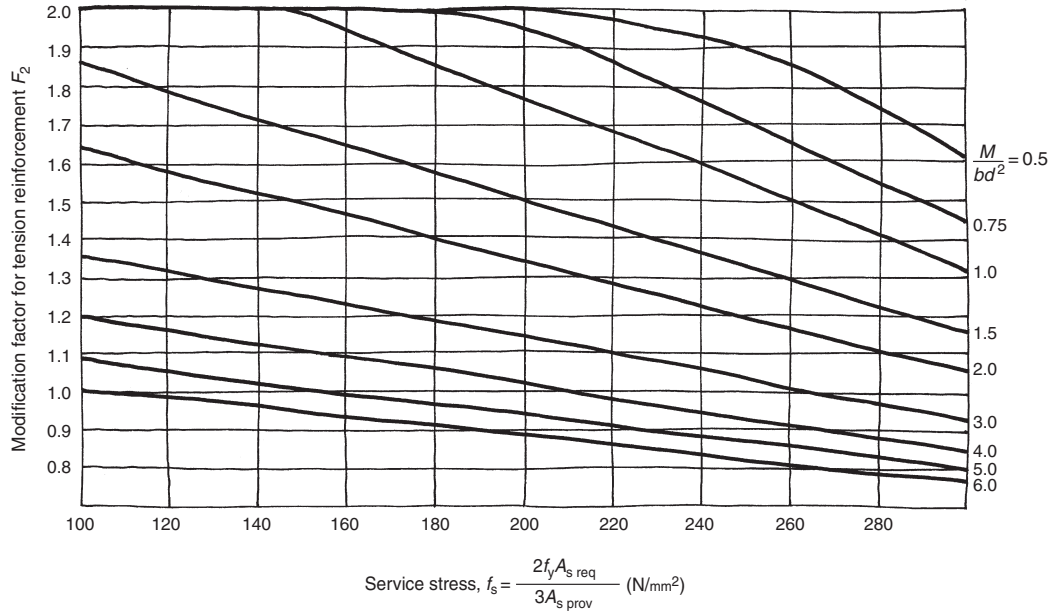

Modification factor for compression reinforcement

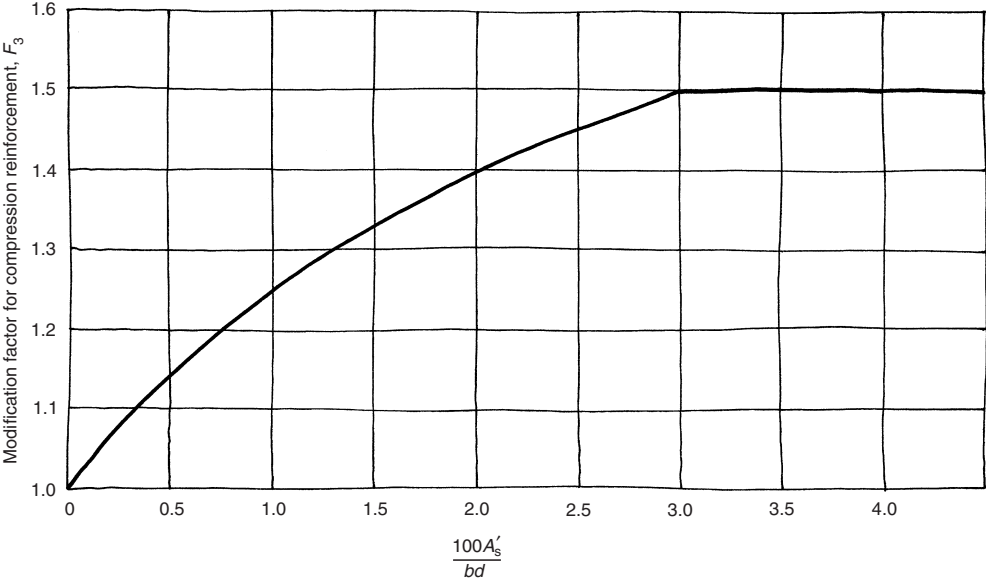

Columns

Vertical elements (of clear height, l , and dimensions, $b \times h$) are considered as columns if $h > 4b$, otherwise they should be considered as walls. Generally the clear column height between restraints should be less than $60b$. It must be established early in the design whether the columns will be in a braced frame where stability is to be provided by shear walls or cores, or whether the columns will be unbraced, meaning that they will maintain the overall stability for the structure. This has a huge effect on the effective length of columns, $l_e = \beta l$, as the design method for columns depends on their slenderness, l_{ex}/b or l_{ey}/h . A column is considered 'stocky' if the slenderness is less than 15 for braced columns or 10 for unbraced columns. Columns exceeding these limits are considered to be 'slender'.

Effective length coefficient (β) for columns

End condition at top of column		End condition at base of column					
		Condition 1		Condition 2		Condition 3	
		Braced	Unbraced	Braced	Unbraced	Braced	Unbraced
Condition 1	'Moment' connection to a beam or foundation which is at least as deep as the column dimension*	0.75	1.20	0.80	1.30	0.90	1.60
Condition 2	'Moment' connection to a beam or foundation which is shallower than the column dimension*	0.80	1.30	0.85	1.50	0.95	1.80
Condition 3	'Pinned' connection	0.90	1.60	0.95	1.80	1.00	n/a
Condition 4	'Free' end	n/a	2.20	n/a	n/a	n/a	n/a

*Column dimensions measured in the direction under consideration.

Source: BS 8110: Part 1: 1997.

Framing moments transferred to columns

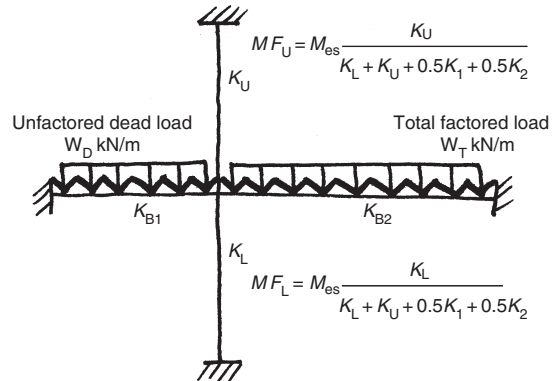
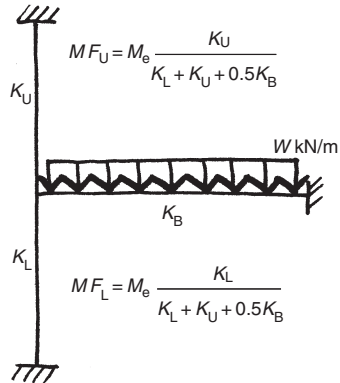

Stiffness, $k = \frac{I}{L}$

M_e = Fixed end beam moment

M_{es} = Total out of balance fixed end moment

Column design methods

Column design charts must be used where the column has to resist axial and bending stresses. Stocky columns need only normally be designed for the maximum design moment about one axis. The minimum design moment is the axial load multiplied by the greater of the eccentricity or $h/20$ in the plane being considered.

If a full frame analysis has not been carried out, the effect of moment transfer can be approximated by using column subframes or by using increasing axial loads by 10% for symmetrical simply supported loads.

Where only a nominal eccentricity moment applies, stocky columns carrying axial load can be designed for: $N = 0.4f_{cu}A_c + 0.75A_s f_y$.

Slender columns can be designed in the same way as short columns, but must resist an additional moment due to eccentricity caused by the deflection of the column as set out in clause 3.8.3 of BS 8110.

Biaxial bending in columns

When it is necessary to consider biaxial moments, the design moment about one axis is enhanced to allow for the biaxial bending effects and the column is designed about the enhanced axis. Where M is the applied moment, d_x is the effective depth across the x - x axis and d_y is the effective depth across the y - y axis:

If $\frac{M_x}{M_y} \geq \frac{d_x}{d_y}$ the increased moment about the x - x axis is $M_{x,enhanced} = M_x + \frac{\beta d_x M_y}{d_y}$.

If $\frac{M_y}{M_x} < \frac{d_y}{d_x}$ the increased moment about the y - y axis is $M_{y,enhanced} = M_y + \frac{\beta d_y M_x}{d_x}$ where β is:

$\frac{N}{bh f_{cu}}$	0.00	0.10	0.20	0.30	0.40	0.50	≥ 0.60
β	1.00	0.88	0.77	0.65	0.53	0.42	0.30

Source: BS 8110: Part 1: 1997.

Reinforced concrete column design charts

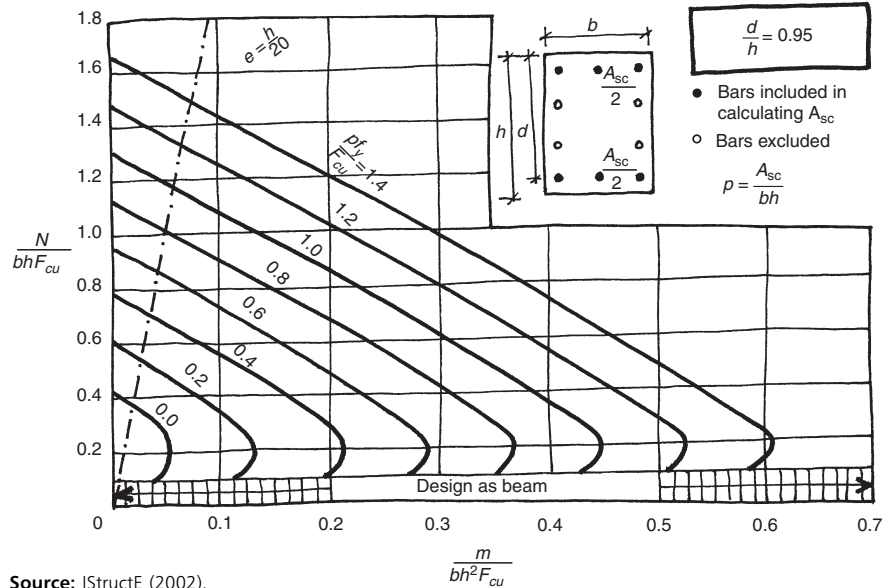

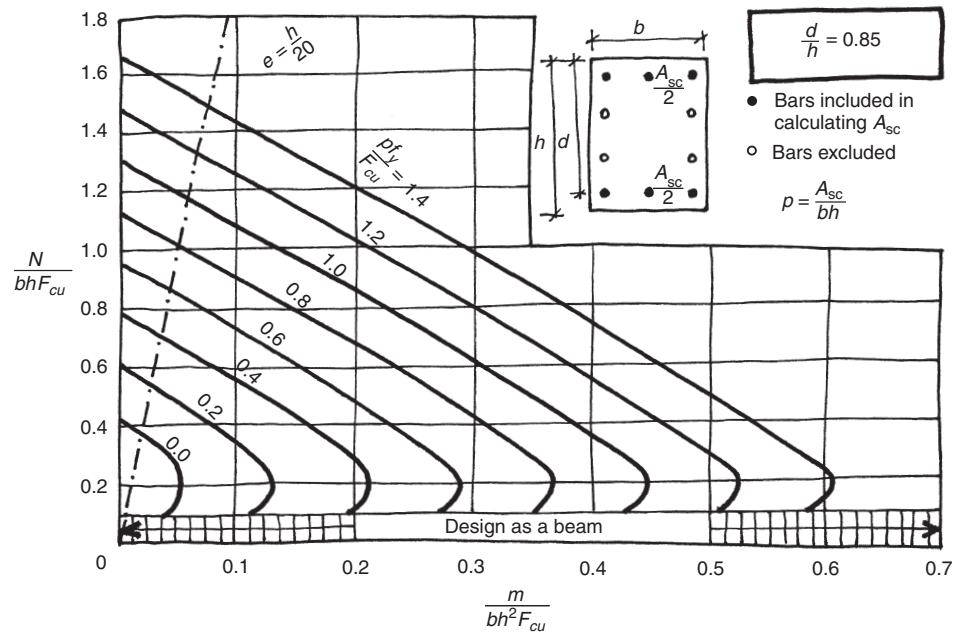

Source: IStructE (2002).

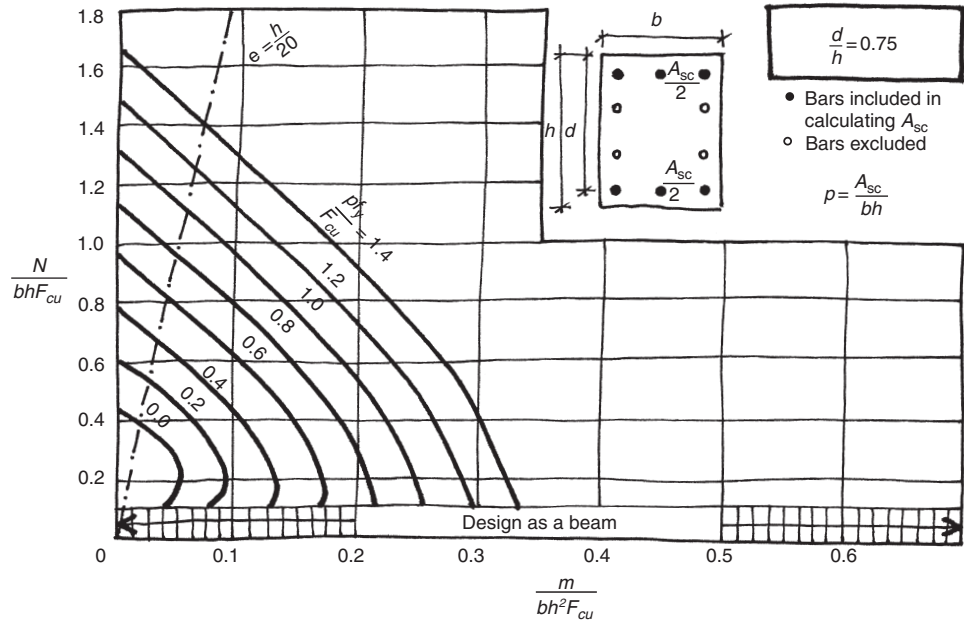

Source: IStructE (2002).

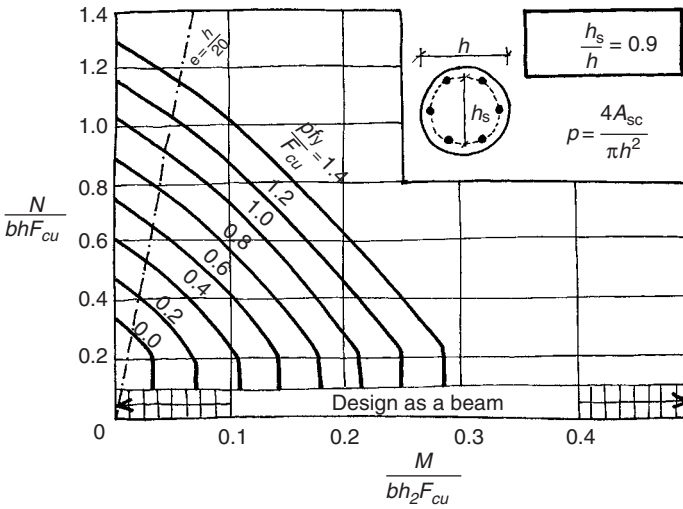

Source: IStructE (2002).

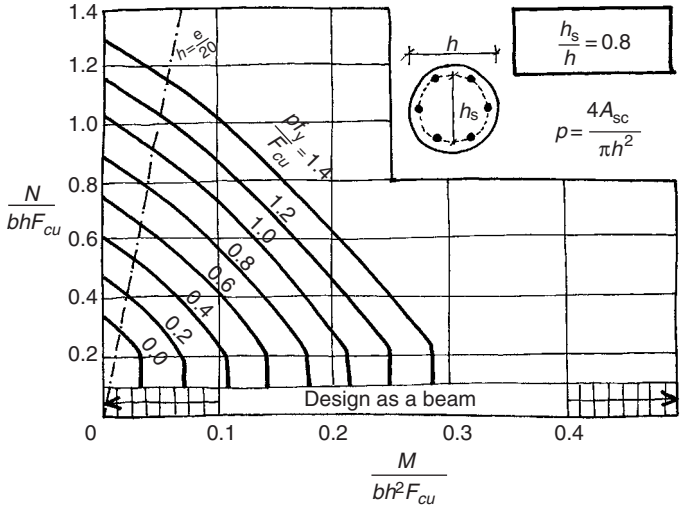

Source: IStructE (2002).

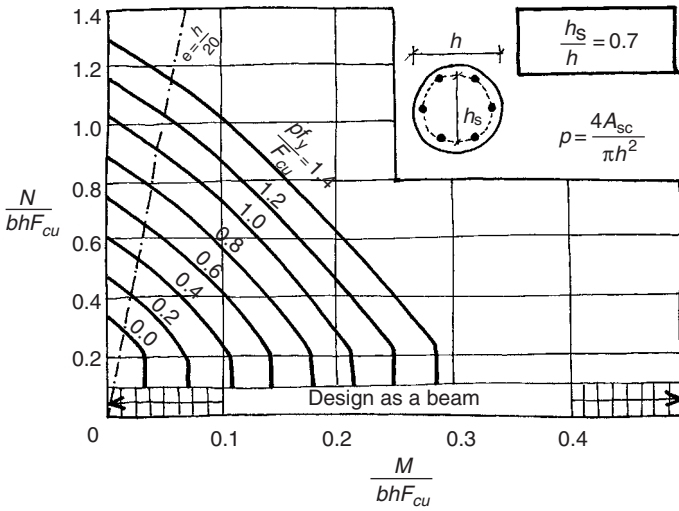

Source: IStructE (2002).

Selected detailing rules for high yield reinforcement to BS 8110

Generally no more than four bars should be arranged in contact at any point. Minimum percentages of reinforcement are intended to control cracking and maximum percentages are intended to ensure that concrete can be placed and adequately compacted around the reinforcement. A_c is the area of the concrete section.

Minimum percentages of reinforcement

For tension reinforcement in rectangular beams/slabs in bending

$$A_s \text{ min} = 0.13\% A_c$$

For compression reinforcement (if required) in rectangular beams in bending

$$A_s \text{ min} = 0.2\% A_c$$

For compression reinforcement in columns

$$A_s \text{ min} = 0.4\% A_c$$

Maximum percentages of reinforcement

For beams

$$A_s \text{ max} = 4\% A_c$$

For vertically cast columns

$$A_s \text{ max} = 6\% A_c$$

For horizontally cast columns

$$A_s \text{ max} = 8\% A_c$$

At lap positions in vertically

$$A_s \text{ max} = 10\% A_c$$

or horizontally cast columns

Selected rules for maximum distance between bars in tension

The maximum bar spacings as set out in clause 3.12.11.2, BS 8110 will limit the crack widths to 0.3 mm. The clear spacing of high yield bars in beams should be less than 135 mm at supports and 160 mm at midspan. In no case should the clear spacing between bars in slabs exceed $3d$ or 750 mm. Reinforcement to resist shrinkage cracking in walls should be at least 0.25% of the concrete cross sectional area for high yield bars, using small diameter bars at relatively close centres.

Typical bond lengths

Bond is the friction and adhesion between the concrete and the steel reinforcement. It depends on the properties of the concrete and steel, as well as the position of the bars within the concrete. Bond forces are transferred through the concrete rather than relying on contact between steel bars. Deformed Type 2 high yield bars are the most commonly used. For a bar diameter, ϕ , basic bond lengths for tension and compression laps are 40ϕ , 38ϕ and 35ϕ , for 30 N/mm^2 , 35 N/mm^2 or 40 N/mm^2 concrete respectively. Tension lap lengths need to be multiplied by 1.4 if the surface concrete cover is less than 2ϕ . If the surface concrete cover to a lap in a corner $< 2\phi$, or the distance between adjacent laps is less than 75 mm or 6ϕ , the bond length should be multiplied by 1.4. If both of these situations occur the bond length should be multiplied by 2.0.

Reinforcement bar bending to BS 8666

BS 8666 sets down the specification for the scheduling, dimensioning, bending and cutting of steel reinforcement for concrete.





Minimum scheduling radius, diameter and bending allowances for reinforcement bars (mm)

Nominal bar diameter, <i>D</i>	Grade R			Grade T		
	Min radius for schedule, <i>R</i>	Min diameter of bending former, <i>M</i>	Min end dimension, <i>A</i>	Min radius for schedule, <i>R</i>	Min diameter of bending former, <i>M</i>	Min end dimension, <i>A</i>
6	12	24	110	12	24	110
8	16	32	115	16	32	115
10	20	40	120	20	40	120
12	24	48	125	24	48	125
16	32	64	130	32	64	130
20	40	80	160	70	140	190
25	50	100	200	87	175	240
32	64	128	260	112	224	305
40	80	160	320	140	280	380

Where Grade R denotes Grade 250 bars and Grade T denotes Grade 460A or 460B deformed type 2 bars (conforming to BS 4449).

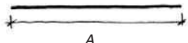
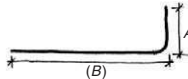
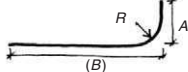
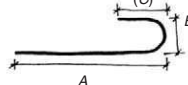
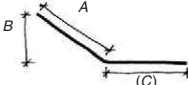
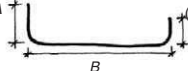
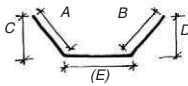
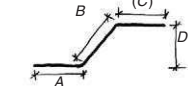
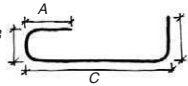
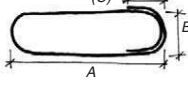
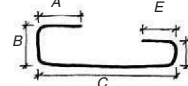
Source: BS 8666: 2000.

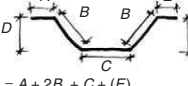
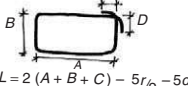
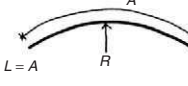
Bar bending shape codes to BS 8666

 <p>$L = A$</p>	 <p>$L = A + (B) - r_{1/2} - d$</p>	 <p>$L = A + (B) - R_{1/2} - d$</p>
 <p>$L = A + 0.57B + (C) - 1.57d$</p>	 <p>$L = A + (C)$</p>	 <p>$L = A + B + (C) - r - 2D$</p>
 <p>$L = A + B + (E)$</p>	 <p>$L = A + B + (C)$</p>	 <p>$L = A + B + C + (D) - 3r_{1/2} - 3d$</p>
 <p>$L = 2A + 3B + 17d$</p>	 <p>$L = A + B + C + D + (E) - 2r - 4d$</p>	 <p>$L = A + B + C + D + (E) - 2r - 4d$</p>
 <p>$L = A + 2B + C + (E)$</p>	 <p>$L = 2(A + B + C) - 5r_{1/2} - 5d$</p>	 <p>$L = A$</p>
<p>C = no. of turns</p>  <p>$L = C\pi(A-d)$</p>		

Source: BS 8666: 2000.

Reinforcement estimates

'Like fountain pens, motor cars and wives, steel estimates have some personal features. It is difficult to lay down hard and fast rules and one can only provide a guide to the uninitiated.' This marvellous (but now rather dated) quote was the introduction to an unpublished guide to better reinforcement estimates. These estimates are difficult to get right and the best estimate is based on a proper design and calculations.

DO NOT: Give a reinforcement estimate to anyone without an independent check by another engineer.

DO: Remember that you use more steel than you think and that although you may remember to be generous, you will inevitably omit more than you overestimate. Compare estimates with similar previous projects. Try to keep the QS happy by differentiating between mild and high tensile steel, straight and bent bars, and bars of different sizes. Apply a factor of safety to the final estimate. Keep a running total of the steel scheduled during preparation of the reinforcement drawings so that if the original estimate starts to look tight, it may be possible to make the ongoing steel detailing more economical.

As a useful check on a detailed estimate, the following are typical reinforcement quantities found in different structural elements:

Slabs	80–110 kg/m ³
RC pad footings	70–90 kg/m ³
Transfer slabs	150 kg/m ³
Pile caps/rafts	115 kg/m ³
Columns	150–450 kg/m ³
Ground beams	230 kg/m ³
Beams	220 kg/m ³
Retaining walls	110 kg/m ³
Stairs	135 kg/m ³
Walls	65 kg/m ³

'All up' estimates for different building types:

Heavy industrial	125 kg/m ³
Commercial	95 kg/m ³
Institutional	85 kg/m ³

Source: Price & Myers (2001).

9

Structural Steel

The method of heating iron ore in a charcoal fire determines the amount of carbon in the iron alloy. The following three iron ore products contain differing amounts of carbon: cast iron, wrought iron and steel.

Cast iron involves the heat treatment of iron castings and was developed as part of the industrial revolution between 1800 and 1900. It has a high carbon content and is therefore quite brittle which means that it has a much greater strength in compression than in tension. Typical allowable working stresses were 23 N/mm² tension, 123 N/mm² compression and 30 N/mm² shear.

Wrought iron has relatively uniform properties and, between the 1840s and 1900, wrought iron took over from cast iron for structural use, until it was in turn superseded by mild steel. Typical allowable working stresses were 81 N/mm² tension, 61 N/mm² compression and 77 N/mm² shear.

'Steel' can cover many different alloys of iron, carbon and other alloying elements to alter the properties of the alloys. The steel can be formed into structural sections by casting, hot rolling or cold rolling. Mild steel which is now mostly used for structural work was first introduced in the mid-nineteenth century.

Types of steel products

Cast steel

Castings are generally used for complex or non-standard structural components. The casting shape and moulding process must be carefully controlled to limit residual stresses. Sand casting is a very common method, but the lost wax method is generally used where a very fine surface finish is required.

Cold rolled

Cold rolling is commonly used for lightweight sections, such as purlins and wind posts, etc. Work hardening and residual stresses caused by the cold working cause an increase in the yield strength but this is at the expense of ductility and toughness. Cold rolled steel cannot be designed using the same method as hot rolled steel and design methods are given in BS 5950: Part 5.

Hot rolled steel

Most steel in the UK is produced by continuous casting where ingots or slabs are pre-heated to about 1300°C and the working temperatures fall as processing continues through the intermediate stages. The total amount of rolling work and the finishing temperatures are controlled to keep the steel grain size fine – which gives a good combination of strength and toughness. Although hollow sections (RHS, CHS and SHS) are often cold bent into shape, they tend to be hot finished and are considered 'hot rolled' for design purposes. This pocket book deals only with hot rolled steel.

Summary of hot rolled steel material properties

Density	78.5 kN/m ³
Tensile strength	275–460 N/mm ² yield stress and 430–550 N/mm ² ultimate strength
Poisson's ratio	0.3
Modulus of elasticity, <i>E</i>	205 kN/mm ²
Modulus of rigidity, <i>G</i>	80 kN/mm ²
Linear coefficient of thermal expansion	$12 \times 10^{-6}/^{\circ}\text{C}$

Mild steel section sizes and tolerances

Fabrication tolerances

BS 4 covers the dimensions of many of the hot rolled sections produced by Corus. Selected rolling tolerances for different sections are covered by the following standards:

UB and UC sections: BS EN 10034

Section height (mm)	$h \leq 180$	$180 < h \leq 400$	$400 < h \leq 700$	$700 < h$
Tolerance (mm)	+3/-2	+4/-2	+5/-3	±5
Flange width (mm)	$b \leq 110$	$110 < b \leq 210$	$210 < b \leq 325$	$325 < b$
Tolerance (mm)	+4/-1	+4/-2	±4	+6/-5
Out of squareness for flange width (mm)	$b \leq 110$		$110 < b$	
Tolerance (mm)	1.5		2% of b up to max 6.5 mm	
Straightness for section height (mm)	$80 < h \leq 180$		$180 < h \leq 360$	$360 < h$
Tolerance on section length (mm)	0.003L		0.0015L	0.001L

RSA sections: BS EN 10056-2

Leg length (mm)	$h \geq 50$	$50 < h \leq 100$	$100 < h \leq 150$	$150 < h \leq 200$	$200 \leq h$
Tolerance (mm)	±1	±2	±3	±4	+6/-4
Straightness for section height	$h \leq 150$		$h \leq 200$	$200 < h$	
Tolerance along section length (mm)	0.004L		0.002L	0.001L	

PFC sections: BS EN 10279

Section height (mm)	$h \leq 65$	$65 < h \leq 200$	$200 < h \leq 400$	$400 < h$
Tolerance (mm)	±1.5	±2	±3	±4
Out of squareness for flange width	$b \leq 100$		$100 < b$	
Tolerance (mm)	1.5		2.5% of b	
Straightness for section height	$h \leq 150$		$150 < h \leq 300$	$300 < h$
Tolerance along section length (mm)	0.005L		0.003L	0.002L

Hot finished RHS, SHS and CHS sections: BS EN 10210

Straightness:	0.2%L
Depth, breadth of diameter:	±1% (min ±0.5 mm and max ±10 mm)
Squareness of side for SHS and RHS:	90° ± 1°
Twist for SHS and RHS:	2 mm + 0.5 mm per m maximum

Examples of minimum bend radii for selected steel sections

The minimum radius to which any section can be curved depends on its metallurgical properties, particularly its ductility, cross sectional geometry and end use (the latter determines the standard required for the appearance of the work). It is therefore not realistic to provide a definitive list of the radii to which every section can be curved due to the wide number of end uses, but a selection of examples is possible. Normal bending tolerances are about 8 mm on the radius. In cold rolling the steel is deformed in the yield stress range and therefore becomes work hardened and displays different mechanical properties (notably a loss of ductility). However, if the section is designed to be working in the elastic range there is generally no significant difference to its performance.

Section	Typical bend radius for S275 steel m
610 × 305 UB 238	40.0
533 × 210 UB 122	30.0
305 × 165 UB 40	15.0
250 × 150 × 12.5 RHS	9.0
305 × 305 UC 118	5.5
300 × 100 PFC 46	4.6
150 × 150 × 12.5 SHS	3.0
254 × 203 RSJ 82	2.4
191 × 229 TEE 49	1.5
152 × 152 UC 37	1.5
125 × 65 PFC 15	1.0
152 × 127 RSJ 37	0.8

Source: Angle Ring Company Limited (2002).

Hot rolled section tables

Universal beams – dimensions and properties

UB designation	Mass per metre	Depth of section	Width of section	Thickness		Root radius	Depth between fillets	Ratios for local buckling		Second moment of area		h/t better known in BS449 as D/T
				Web	Flange			Flange	Web	Axis x-x	Axis y-y	
				kg/m	mm			mm	mm	mm	mm	
† 1016 × 305 × 487	486.6	1036.1	308.5	30	54.1	30	867.9	2.85	28.9	1021400	26720	19
† 1016 × 305 × 437	436.9	1025.9	305.4	26.9	49	30	867.9	3.12	32.3	909900	23450	21
† 1016 × 305 × 393	392.7	1016	303	24.4	43.9	30	868.2	3.45	35.6	807700	20500	23
† 1016 × 305 × 349	349.4	1008.1	302	21.1	40	30	868.1	3.77	41.1	723100	18460	25
† 1016 × 305 × 314	314.3	1000	300	19.1	35.9	30	868.2	4.18	45.5	644200	16230	28
† 1016 × 305 × 272	272.3	990.1	300	16.5	31	30	868.1	4.84	52.6	554000	14000	32
† 1016 × 305 × 249	248.7	980.2	300	16.5	26	30	868.2	5.77	52.6	481300	11750	38
† 1016 × 305 × 222	222	970.3	300	16	21.1	30	868.1	7.11	54.3	408000	9546	46
914 × 419 × 388	388	921	420.5	21.4	36.6	24.1	799.6	5.74	37.4	719600	45440	25
914 × 419 × 343	343.3	911.8	418.5	19.4	32	24.1	799.6	6.54	41.2	625800	39160	28
914 × 305 × 289	289.1	926.6	307.7	19.5	32	19.1	824.4	4.81	42.3	504200	15600	29
914 × 305 × 253	253.4	918.4	305.5	17.3	27.9	19.1	824.4	5.47	47.7	436300	13300	33
914 × 305 × 224	224.2	910.4	304.1	15.9	23.9	19.1	824.4	6.36	51.8	376400	11240	38
914 × 305 × 201	200.9	903	303.3	15.1	20.2	19.1	824.4	7.51	54.6	325300	9423	45
838 × 292 × 226	226.5	850.9	293.8	16.1	26.8	17.8	761.7	5.48	47.3	339700	11360	32
838 × 292 × 194	193.8	840.7	292.4	14.7	21.7	17.8	761.7	6.74	51.8	279200	9066	39
838 × 292 × 176	175.9	834.9	291.7	14	18.8	17.8	761.7	7.76	54.4	246000	7799	44
762 × 267 × 197	196.8	769.8	268	15.6	25.4	16.5	686	5.28	44	240000	8175	30
762 × 267 × 173	173	762.2	266.7	14.3	21.6	16.5	686	6.17	48	205300	6850	35
762 × 267 × 147	146.9	754	265.2	12.8	17.5	16.5	686	7.58	53.6	168500	5455	43
762 × 267 × 134	133.9	750	264.4	12	15.5	16.5	686	8.53	57.2	150700	4788	48
686 × 254 × 170	170.2	692.9	255.8	14.5	23.7	15.2	615.1	5.4	42.4	170300	6630	29
686 × 254 × 152	152.4	687.5	254.5	13.2	21	15.2	615.1	6.06	46.6	150400	5784	33
686 × 254 × 140	140.1	683.5	253.7	12.4	19	15.2	615.1	6.68	49.6	136300	5183	36
686 × 254 × 125	125.2	677.9	253	11.7	16.2	15.2	615.1	7.81	52.6	118000	4383	42
610 × 305 × 238	238.1	635.8	311.4	18.4	31.4	16.5	540	4.96	29.3	209500	15840	20
610 × 305 × 179	179	620.2	307.1	14.1	23.6	16.5	540	6.51	38.3	153000	11410	26
610 × 305 × 149	149.2	612.4	304.8	11.8	19.7	16.5	540	7.74	45.8	125900	9308	31
610 × 229 × 140	139.9	617.2	230.2	13.1	22.1	12.7	547.6	5.21	41.8	111800	4505	28
610 × 229 × 125	125.1	612.2	229	11.9	19.6	12.7	547.6	5.84	46	98610	3932	31
610 × 229 × 113	113	607.6	228.2	11.1	17.3	12.7	547.6	6.6	49.3	87320	3434	35
610 × 229 × 101	101.2	602.6	227.6	10.5	14.8	12.7	547.6	7.69	52.2	75780	2915	41
533 × 210 × 122	122	544.5	211.9	12.7	21.3	12.7	476.5	4.97	37.5	76040	3388	26
533 × 210 × 109	109	539.5	210.8	11.6	18.8	12.7	476.5	5.61	41.1	66820	2943	29
533 × 210 × 101	101	536.7	210	10.8	17.4	12.7	476.5	6.03	44.1	61520	2692	31
533 × 210 × 92	92.14	533.1	209.3	10.1	15.6	12.7	476.5	6.71	47.2	55230	2389	34
533 × 210 × 82	82.2	528.3	208.8	9.6	13.2	12.7	476.5	7.91	49.6	47540	2007	40
457 × 191 × 98	98.3	467.2	192.8	11.4	19.6	10.2	407.6	4.92	35.8	45730	2347	24
457 × 191 × 89	89.3	463.4	191.9	10.5	17.7	10.2	407.6	5.42	38.8	41020	2089	26
457 × 191 × 82	82	460	191.3	9.9	16	10.2	407.6	5.98	41.2	37050	1871	29
457 × 191 × 74	74.3	457	190.4	9	14.5	10.2	407.6	6.57	45.3	33320	1671	32
457 × 191 × 67	67.1	453.4	189.9	8.5	12.7	10.2	407.6	7.48	48	29380	1452	36

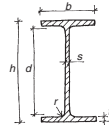

Radius of gyration		Elastic modulus		Plastic modulus		Buckling parameter	Torsional index	Warping constant	Torsional constant	Area of section
Axis x-x r_x	Axis y-y r_y	Axis x-x Z_x	Axis y-y Z_y	Axis x-x S_x	Axis y-y S_y					
cm	cm	cm ³	cm ³	cm ³	cm ³	u	x	H	J	A
40.6	6.57	19720	1732	23200	2800	0.867	21.1	64.4	4299	620
40.4	6.49	17740	1535	20760	2469	0.868	23.1	55.9	3185	557
40.2	6.4	15900	1353	18540	2168	0.868	25.5	48.4	2330	500
40.3	6.44	14350	1223	16590	1941	0.872	27.9	43.3	1718	445
40.1	6.37	12880	1082	14850	1713	0.872	30.7	37.7	1264	400
40	6.35	11190	934	12830	1470	0.873	35	32.2	835	347
39	6.09	9821	784	11350	1245	0.861	39.9	26.8	582	317
38	5.81	8409	636	9807	1020	0.85	45.7	21.5	390	283
38.2	9.59	15630	2161	17670	3341	0.885	26.7	88.9	1734	494
37.8	9.46	13730	1871	15480	2890	0.883	30.1	75.8	1193	437
37	6.51	10880	1014	12570	1601	0.867	31.9	31.2	926	368
36.8	6.42	9501	871	10940	1371	0.866	36.2	26.4	626	323
36.3	6.27	8269	739	9535	1163	0.861	41.3	22.1	422	286
35.7	6.07	7204	621	8351	982	0.854	46.8	18.4	291	256
34.3	6.27	7985	773	9155	1212	0.87	35	19.3	514	289
33.6	6.06	6641	620	7640	974	0.862	41.6	15.2	306	247
33.1	5.9	5893	535	6808	842	0.856	46.5	13	221	224
30.9	5.71	6234	610	7167	959	0.869	33.2	11.3	404	251
30.5	5.58	5387	514	6198	807	0.864	38.1	9.39	267	220
30	5.4	4470	411	5156	647	0.858	45.2	7.4	159	187
29.7	5.3	4018	362	4644	570	0.854	49.8	6.46	119	171
28	5.53	4916	518	5631	811	0.872	31.8	7.42	308	217
27.8	5.46	4374	455	5000	710	0.871	35.5	6.42	220	194
27.6	5.39	3987	409	4558	638	0.868	38.7	5.72	169	178
27.2	5.24	3481	346	3994	542	0.862	43.9	4.8	116	159
26.3	7.23	6589	1017	7486	1574	0.886	21.3	14.5	785	303
25.9	7.07	4935	743	5547	1144	0.886	27.7	10.2	340	228
25.7	7	4111	611	4594	937	0.886	32.7	8.17	200	190
25	5.03	3622	391	4142	611	0.875	30.6	3.99	216	178
24.9	4.97	3221	343	3676	535	0.873	34.1	3.45	154	159
24.6	4.88	2874	301	3281	469	0.87	38	2.99	111	144
24.2	4.75	2515	256	2881	400	0.864	43.1	2.52	77	129
22.1	4.67	2793	320	3196	500	0.877	27.6	2.32	178	155
21.9	4.6	2477	279	2828	436	0.875	30.9	1.99	126	139
21.9	4.57	2292	256	2612	399	0.874	33.2	1.81	101	129
21.7	4.51	2072	228	2360	356	0.872	36.5	1.6	75.7	117
21.3	4.38	1800	192	2059	300	0.864	41.6	1.33	51.5	105
19.1	4.33	1957	243	2232	379	0.881	25.7	1.18	121	125
19	4.29	1770	218	2014	338	0.88	28.3	1.04	90.7	114
18.8	4.23	1611	196	1831	304	0.877	30.9	0.922	69.2	104
18.8	4.2	1458	176	1653	272	0.877	33.9	0.818	51.8	94.6
18.5	4.12	1296	153	1471	237	0.872	37.9	0.705	37.1	85.5

Source: Corus Construction (2002). Copyright Corus UK Ltd – reproduced with the kind permission of Corus UK Ltd.

Universal beams – dimensions and properties

UB designation	Mass per metre	Depth of section	Width of section	Thickness		Root radius	Depth between fillets	Ratios for local buckling		Second moment of area		h/t better known in BS449 as D/T
				Web	Flange			Flange	Web	Axis x-x	Axis y-y	
	kg/m	mm	mm	mm	mm	mm	mm	b/2t	d/s	I_x	I_y	
457 × 152 × 60	59.8	454.6	152.9	8.1	13.3	10.2	407.6	5.75	50.3	25500	795	34
457 × 152 × 52	52.3	449.8	152.4	7.6	10.9	10.2	407.6	6.99	53.6	21370	645	41
406 × 178 × 74	74.2	412.8	179.5	9.5	16	10.2	360.4	5.61	37.9	27310	1545	26
406 × 178 × 67	67.1	409.4	178.8	8.8	14.3	10.2	360.4	6.25	41	24330	1365	29
406 × 178 × 60	60.1	406.4	177.9	7.9	12.8	10.2	360.4	6.95	45.6	21600	1203	32
406 × 178 × 54	54.1	402.6	177.7	7.7	10.9	10.2	360.4	8.15	46.8	18720	1021	37
406 × 140 × 46	46	403.2	142.2	6.8	11.2	10.2	360.4	6.35	53	15690	538	36
406 × 140 × 39	39	398	141.8	6.4	8.6	10.2	360.4	8.24	56.3	12510	410	46
356 × 171 × 67	67.1	363.4	173.2	9.1	15.7	10.2	311.6	5.52	34.2	19460	1362	23
356 × 171 × 57	57	358	172.2	8.1	13	10.2	311.6	6.62	38.5	16040	1108	28
356 × 171 × 51	51	355	171.5	7.4	11.5	10.2	311.6	7.46	42.1	14140	968	31
356 × 171 × 45	45	351.4	171.1	7	9.7	10.2	311.6	8.82	44.5	12070	811	36
356 × 127 × 39	39.1	353.4	126	6.6	10.7	10.2	311.6	5.89	47.2	10170	358	33
356 × 127 × 33	33.1	349	125.4	6	8.5	10.2	311.6	7.38	51.9	8249	280	41
305 × 165 × 54	54	310.4	166.9	7.9	13.7	8.9	265.2	6.09	33.6	11700	1063	23
305 × 165 × 46	46.1	306.6	165.7	6.7	11.8	8.9	265.2	7.02	39.6	9899	896	26
305 × 165 × 40	40.3	303.4	165	6	10.2	8.9	265.2	8.09	44.2	8503	764	30
305 × 127 × 48	48.1	311	125.3	9	14	8.9	265.2	4.47	29.5	9575	461	22
305 × 127 × 42	41.9	307.2	124.3	8	12.1	8.9	265.2	5.14	33.1	8196	389	25
305 × 127 × 37	37	304.4	123.4	7.1	10.7	8.9	265.2	5.77	37.4	7171	336	28
305 × 102 × 33	32.8	312.7	102.4	6.6	10.8	7.6	275.9	4.74	41.8	6501	194	29
305 × 102 × 28	28.2	308.7	101.8	6	8.8	7.6	275.9	5.78	46	5366	155	35
305 × 102 × 25	24.8	305.1	101.6	5.8	7	7.6	275.9	7.26	47.6	4455	123	44
254 × 146 × 43	43	259.6	147.3	7.2	12.7	7.6	219	5.8	30.4	6544	677	20
254 × 146 × 37	37	256	146.4	6.3	10.9	7.6	219	6.72	34.8	5537	571	23
254 × 146 × 31	31.1	251.4	146.1	6	8.6	7.6	219	8.49	36.5	4413	448	29
254 × 102 × 28	28.3	260.4	102.2	6.3	10	7.6	225.2	5.11	35.7	4005	179	26
254 × 102 × 25	25.2	257.2	101.9	6	8.4	7.6	225.2	6.07	37.5	3415	149	31
254 × 102 × 22	22	254	101.6	5.7	6.8	7.6	225.2	7.47	39.5	2841	119	37
203 × 133 × 30	30	206.8	133.9	6.4	9.6	7.6	172.4	6.97	26.9	2896	385	22
203 × 133 × 25	25.1	203.2	133.2	5.7	7.8	7.6	172.4	8.54	30.2	2340	308	26
203 × 102 × 23	23.1	203.2	101.8	5.4	9.3	7.6	169.4	5.47	31.4	2105	164	22
178 × 102 × 19	19	177.8	101.2	4.8	7.9	7.6	146.8	6.41	30.6	1356	137	23
152 × 89 × 16	16	152.4	88.7	4.5	7.7	7.6	121.8	5.76	27.1	834	89.8	20
127 × 76 × 13	13	127	76	4	7.6	7.6	96.6	5	24.1	473	55.7	17

†Additional sizes to BS4 available in UK.

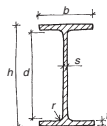

Radius of gyration		Elastic modulus		Plastic modulus		Buckling parameter	Torsional index	Warping constant	Torsional constant	Area of section
Axis x-x	Axis y-y	Axis x-x	Axis y-y	Axis x-x	Axis y-y					
r_x	r_y	Z_x	Z_y	S_x	S_y	u	x	H	J	A
cm	cm	cm ³	cm ³	cm ³	cm ³			dm ⁶	cm ⁴	cm ²
18.3	3.23	1122	104	1287	163	0.868	37.5	0.387	33.8	76.2
17.9	3.11	950	84.6	1096	133	0.859	43.9	0.311	21.4	66.6
17	4.04	1323	172	1501	267	0.882	27.6	0.608	62.8	94.5
16.9	3.99	1189	153	1346	237	0.88	30.5	0.533	46.1	85.5
16.8	3.97	1063	135	1199	209	0.88	33.8	0.466	33.3	76.5
16.5	3.85	930	115	1055	178	0.871	38.3	0.392	23.1	69
16.4	3.03	778	75.7	888	118	0.871	38.9	0.207	19	58.6
15.9	2.87	629	57.8	724	90.8	0.858	47.5	0.155	10.7	49.7
15.1	3.99	1071	157	1211	243	0.886	24.4	0.412	55.7	85.5
14.9	3.91	896	129	1010	199	0.882	28.8	0.33	33.4	72.6
14.8	3.86	796	113	896	174	0.881	32.1	0.286	23.8	64.9
14.5	3.76	687	94.8	775	147	0.874	36.8	0.237	15.8	57.3
14.3	2.68	576	56.8	659	89.1	0.871	35.2	0.105	15.1	49.8
14	2.58	473	44.7	543	70.3	0.863	42.2	0.081	8.79	42.1
13	3.93	754	127	846	196	0.889	23.6	0.234	34.8	68.8
13	3.9	646	108	720	166	0.891	27.1	0.195	22.2	58.7
12.9	3.86	560	92.6	623	142	0.889	31	0.164	14.7	51.3
12.5	2.74	616	73.6	711	116	0.873	23.3	0.102	31.8	61.2
12.4	2.7	534	62.6	614	98.4	0.872	26.5	0.085	21.1	53.4
12.3	2.67	471	54.5	539	85.4	0.872	29.7	0.072	14.8	47.2
12.5	2.15	416	37.9	481	60	0.866	31.6	0.044	12.2	41.8
12.2	2.08	348	30.5	403	48.5	0.859	37.4	0.035	7.4	35.9
11.9	1.97	292	24.2	342	38.8	0.846	43.4	0.027	4.77	31.6
10.9	3.52	504	92	566	141	0.891	21.2	0.103	23.9	54.8
10.8	3.48	433	78	483	119	0.89	24.3	0.086	15.3	47.2
10.1	3.36	351	61.3	393	94.1	0.88	29.6	0.066	8.55	39.7
10.5	2.22	308	34.9	353	54.8	0.874	27.5	0.028	9.57	36.1
10.3	2.15	266	29.2	306	46	0.866	31.5	0.023	6.42	32
10.1	2.06	224	23.5	259	37.3	0.856	36.4	0.018	4.15	28
8.71	3.17	280	57.5	314	88.2	0.881	21.5	0.037	10.3	38.2
8.56	3.1	230	46.2	258	70.9	0.877	25.6	0.029	5.96	32
8.46	2.36	207	32.2	234	49.8	0.888	22.5	0.015	7.02	29.4
7.48	2.37	153	27	171	41.6	0.888	22.6	0.01	4.41	24.3
6.41	2.1	109	20.2	123	31.2	0.89	19.6	0.005	3.56	20.3
5.35	1.84	74.6	14.7	84.2	22.6	0.895	16.3	0.002	2.85	16.5

Source: Corus Construction (2002). Copyright Corus UK Ltd – reproduced with the kind permission of Corus UK Ltd.

Universal columns – dimensions and properties

UC designation	Mass per metre	Depth of section	Width of section	Thickness		Root radius	Depth between fillets	Ratios for local buckling		Second moment of area		h/t better known in BS449 as
				Web	Flange			Flange	Web	Axis x-x	Axis y-y	
	kg/m	h	b	s	t	r	d	b/2t	d/s	I _x	I _y	D/T
356 × 406 × 634	633.9	474.6	424	47.6	77	15.2	290.2	2.75	6.1	274800	98130	6
356 × 406 × 551	551	455.6	418.5	42.1	67.5	15.2	290.2	3.1	6.89	226900	82670	7
356 × 406 × 467	467	436.6	412.2	35.8	58	15.2	290.2	3.55	8.11	183000	67830	8
356 × 406 × 393	393	419	407	30.6	49.2	15.2	290.2	4.14	9.48	146600	55370	9
356 × 406 × 340	339.9	406.4	403	26.6	42.9	15.2	290.2	4.7	10.9	122500	46850	9
356 × 406 × 287	287.1	393.6	399	22.6	36.5	15.2	290.2	5.47	12.8	99880	38680	11
356 × 406 × 235	235.1	381	394.8	18.4	30.2	15.2	290.2	6.54	15.8	79080	30990	13
356 × 368 × 202	201.9	374.6	374.7	16.5	27	15.2	290.2	6.94	17.6	66260	23690	14
356 × 368 × 177	177	368.2	372.6	14.4	23.8	15.2	290.2	7.83	20.2	57120	20530	15
356 × 368 × 153	152.9	362	370.5	12.3	20.7	15.2	290.2	8.95	23.6	48590	17550	17
356 × 368 × 129	129	355.6	368.6	10.4	17.5	15.2	290.2	10.5	27.9	40250	14610	20
305 × 305 × 283	282.9	365.3	322.2	26.8	44.1	15.2	246.7	3.65	9.21	78870	24630	8
305 × 305 × 240	240	352.5	318.4	23	37.7	15.2	246.7	4.22	10.7	64200	20310	9
305 × 305 × 198	198.1	339.9	314.5	19.1	31.4	15.2	246.7	5.01	12.9	50900	16300	11
305 × 305 × 158	158.1	327.1	311.2	15.8	25	15.2	246.7	6.22	15.6	38750	12570	13
305 × 305 × 137	136.9	320.5	309.2	13.8	21.7	15.2	246.7	7.12	17.9	32810	10700	15
305 × 305 × 118	117.9	314.5	307.4	12	18.7	15.2	246.7	8.22	20.6	27670	9059	17
305 × 305 × 97	96.9	307.9	305.3	9.9	15.4	15.2	246.7	9.91	24.9	22250	7308	20
254 × 254 × 167	167.1	289.1	265.2	19.2	31.7	12.7	200.3	4.18	10.4	30000	9870	9
254 × 254 × 132	132	276.3	261.3	15.3	25.3	12.7	200.3	5.16	13.1	22530	7531	11
254 × 254 × 107	107.1	266.7	258.8	12.8	20.5	12.7	200.3	6.31	15.6	17510	5928	13
254 × 254 × 89	88.9	260.3	256.3	10.3	17.3	12.7	200.3	7.41	19.4	14270	4857	15
254 × 254 × 73	73.1	254.1	254.6	8.6	14.2	12.7	200.3	8.96	23.3	11410	3908	18
203 × 203 × 86	86.1	222.2	209.1	12.7	20.5	10.2	160.8	5.1	12.7	9449	3127	11
203 × 203 × 71	71	215.8	206.4	10	17.3	10.2	160.8	5.97	16.1	7618	2537	12
203 × 203 × 60	60	209.6	205.8	9.4	14.2	10.2	160.8	7.25	17.1	6125	2065	15
203 × 203 × 52	52	206.2	204.3	7.9	12.5	10.2	160.8	8.17	20.4	5259	1778	16
203 × 203 × 46	46.1	203.2	203.6	7.2	11	10.2	160.8	9.25	22.3	4568	1548	18
152 × 152 × 37	37	161.8	154.4	8	11.5	7.6	123.6	6.71	15.5	2210	706	14
152 × 152 × 30	30	157.6	152.9	6.5	9.4	7.6	123.6	8.13	19	1748	560	17
152 × 152 × 23	23	152.4	152.2	5.8	6.8	7.6	123.6	11.2	21.3	1250	400	22

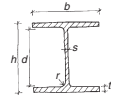

Radius of gyration		Elastic modulus		Plastic modulus		Buckling parameter	Torsional index	Warping constant	Torsional constant	Area of section
Axis x-x r_x	Axis y-y r_y	Axis x-x Z_x	Axis y-y Z_y	Axis x-x S_x	Axis y-y S_y					
cm	cm	cm ³	cm ³	cm ³	cm ³			dm ⁶	cm ⁴	cm ²
18.4	11	11580	4629	14240	7108	0.843	5.46	38.8	13720	808
18	10.9	9962	3951	12080	6058	0.841	6.05	31.1	9240	702
17.5	10.7	8383	3291	10000	5034	0.839	6.86	24.3	5809	595
17.1	10.5	6998	2721	8222	4154	0.837	7.86	18.9	3545	501
16.8	10.4	6031	2325	6999	3544	0.836	8.85	15.5	2343	433
16.5	10.3	5075	1939	5812	2949	0.835	10.2	12.3	1441	366
16.3	10.2	4151	1570	4687	2383	0.834	12.1	9.54	812	299
16.1	9.6	3538	1264	3972	1920	0.844	13.4	7.16	558	257
15.9	9.54	3103	1102	3455	1671	0.844	15	6.09	381	226
15.8	9.49	2684	948	2965	1435	0.844	17	5.11	251	195
15.6	9.43	2264	793	2479	1199	0.844	19.9	4.18	153	164
14.8	8.27	4318	1529	5105	2342	0.855	7.65	6.35	2034	360
14.5	8.15	3643	1276	4247	1951	0.854	8.74	5.03	1271	306
14.2	8.04	2995	1037	3440	1581	0.854	10.2	3.88	734	252
13.9	7.9	2369	808	2680	1230	0.851	12.5	2.87	378	201
13.7	7.83	2048	692	2297	1053	0.851	14.2	2.39	249	174
13.6	7.77	1760	589	1958	895	0.85	16.2	1.98	161	150
13.4	7.69	1445	479	1592	726	0.85	19.3	1.56	91.2	123
11.9	6.81	2075	744	2424	1137	0.851	8.49	1.63	626	213
11.6	6.69	1631	576	1869	878	0.85	10.3	1.19	319	168
11.3	6.59	1313	458	1484	697	0.848	12.4	0.898	172	136
11.2	6.55	1096	379	1224	575	0.85	14.5	0.717	102	113
11.1	6.48	898	307	992	465	0.849	17.3	0.562	57.6	93.1
9.28	5.34	850	299	977	456	0.85	10.2	0.318	137	110
9.18	5.3	706	246	799	374	0.853	11.9	0.25	80.2	90.4
8.96	5.2	584	201	656	305	0.846	14.1	0.197	47.2	76.4
8.91	5.18	510	174	567	264	0.848	15.8	0.167	31.8	66.3
8.82	5.13	450	152	497	231	0.847	17.7	0.143	22.2	58.7
6.85	3.87	273	91.5	309	140	0.848	13.3	0.04	19.2	47.1
6.76	3.83	222	73.3	248	112	0.849	16	0.031	10.5	38.3
6.54	3.7	164	52.6	182	80.2	0.84	20.7	0.021	4.63	29.2

Source: Corus Construction (2002). Copyright Corus UK Ltd – reproduced with the kind permission of Corus UK Ltd.

Rolled steel joists – dimensions and properties

Inside slope = 8°

RSJ designation	Mass per metre	Depth of section	Width of section	Thickness		Radius		Depth between fillets	Ratios for local buckling		Second moment of area		h/t better known in BS449 as
				Web	Flange	Root	Toe		Flange	Web	Axis x-x	Axis y-y	
				s	t	r ₁	r ₂		b/2t	d/s	I _x	I _y	
kg/m	mm	mm	mm	mm	mm	mm	mm			cm ⁴	cm ⁴		
254 × 203 × 82	82	254	203.2	10.2	19.9	19.6	9.7	166.6	5.11	16.3	12020	2280	13
203 × 152 × 52	52.3	203.2	152.4	8.9	16.5	15.5	7.6	133.2	4.62	15	4798	816	12
152 × 127 × 37	37.3	152.4	127	10.4	13.2	13.5	6.6	94.3	4.81	9.07	1818	378	12
127 × 114 × 29	29.3	127	114.3	10.2	11.5	9.9	4.8	79.5	4.97	7.79	979	242	11
127 × 114 × 27	26.9	127	114.3	7.4	11.4	9.9	5	79.5	5.01	10.7	946	236	11
102 × 102 × 23	23	101.6	101.6	9.5	10.3	11.1	3.2	55.2	4.93	5.81	486	154	10
102 × 44 × 7	7.5	101.6	44.5	4.3	6.1	6.9	3.3	74.6	3.65	17.3	153	7.82	17
89 × 89 × 19	19.5	88.9	88.9	9.5	9.9	11.1	3.2	44.2	4.49	4.65	307	101	9
76 × 76 × 13	12.8	76.2	76.2	5.1	8.4	9.4	4.6	38.1	4.54	7.47	158	51.8	9

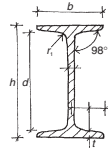

Radius of gyration		Elastic modulus		Plastic modulus		Buckling parameter u	Torsional index x	Warping constant H	Torsional constant J	Area of section A
Axis $x-x$	Axis $y-y$	Axis $x-x$	Axis $y-y$	Axis $x-x$	Axis $y-y$					
cm	cm	cm ³	cm ³	cm ³	cm ³			dm ⁶	cm ⁴	cm ²
10.7	4.67	947	224	1077	371	0.89	11	0.312	152	105
8.49	3.5	472	107	541	176	0.891	10.7	0.0711	64.8	66.6
6.19	2.82	239	59.6	279	99.8	0.866	9.33	0.0183	33.9	47.5
5.12	2.54	154	42.3	181	70.8	0.853	8.76	0.00807	20.8	37.4
5.26	2.63	149	41.3	172	68.2	0.868	9.32	0.00788	16.9	34.2
4.07	2.29	95.6	30.3	113	50.6	0.836	7.43	0.00321	14.2	29.3
4.01	0.907	30.1	3.51	35.4	6.03	0.872	14.9	0.000178	1.25	9.5
3.51	2.02	69	22.8	82.7	38	0.83	6.57	0.00158	11.5	24.9
3.12	1.79	41.5	13.6	48.7	22.4	0.852	7.22	0.000595	4.59	16.2

Parallel flange channels – dimensions and properties

PFC designation	Mass Per metre	Depth of section <i>D</i>	Width of section <i>B</i>	Thickness		Root radius <i>r</i>	Depth between <i>nd</i>	Ratios for local buckling		Second moment of area		h/t better known in BS449 as <i>D/T</i>
				Web <i>t</i>	Flange <i>T</i>			Flange <i>b/t</i>	Web <i>d/t</i>	Axis <i>x-x</i>	Axis <i>y-y</i>	
	kg/m	mm	mm	mm	mm	mm	mm			cm ⁴	cm ⁴	
430 × 100 × 64	64.4	430	100	11	19	15	362	5.26	32.9	21940	722	23
380 × 100 × 54	54.0	380	100	9.5	17.5	15	315	5.71	33.2	15030	643	22
300 × 100 × 46	45.5	300	100	9	16.5	15	237	6.06	26.3	8229	568	18
300 × 90 × 41	41.4	300	90	9	15.5	12	245	5.81	27.2	7218	404	19
260 × 90 × 35	34.8	260	90	8	14	12	208	6.43	26	4728	353	19
260 × 75 × 28	27.6	260	75	7	12	12	212	6.25	30.3	3619	185	22
230 × 90 × 32	32.2	230	90	7.5	14	12	178	6.43	23.7	3518	334	16
230 × 75 × 26	25.7	230	75	6.5	12.5	12	181	6	27.8	2748	181	18
200 × 90 × 30	29.7	200	90	7	14	12	148	6.43	21.1	2523	314	14
200 × 75 × 23	23.4	200	75	6	12.5	12	151	6	25.2	1963	170	16
180 × 90 × 26	26.1	180	90	6.5	12.5	12	131	7.2	20.2	1817	277	14
180 × 75 × 20	20.3	180	75	6	10.5	12	135	7.14	22.5	1370	146	17
150 × 90 × 24	23.9	150	90	6.5	12	12	102	7.5	15.7	1162	253	13
150 × 75 × 18	17.9	150	75	5.5	10	12	106	7.5	19.3	861	131	15
125 × 65 × 15	14.8	125	65	5.5	9.5	12	82	6.84	14.9	483	80	13
100 × 50 × 10	10.2	100	50	5	8.5	9	65	5.88	13	208	32.3	12

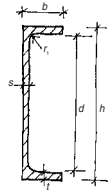

Radius of gyration		Elastic modulus		Elastic NA	Plastic modulus		Plastic NA	Buckling parameter	Torsional index	Warping constant	Torsional constant	Area of section
Axis x-x	Axis y-y	Axis x-x	Axis y-y		Axis x-x	Axis y-y						
kg/m	mm	mm	mm	mm	mm	mm		u	x	H	J	A
16.3	2.97	1020	97.9	2.62	1222	176	0.954	0.917	22.5	0.219	63	82.1
14.8	3.06	791	89.2	2.79	933	161	0.904	0.932	21.2	0.15	45.7	68.7
11.9	3.13	549	81.7	3.05	641	148	1.31	0.944	17	0.081	36.8	58
11.7	2.77	481	63.1	2.6	568	114	0.879	0.934	18.4	0.058	28.8	52.7
10.3	2.82	364	56.3	2.74	425	102	1.14	0.942	17.2	0.038	20.6	44.4
10.1	2.3	278	34.4	2.1	328	62	0.676	0.932	20.5	0.02	11.7	35.1
9.27	2.86	306	55	2.92	355	98.9	1.69	0.95	15.1	0.028	19.3	41
9.17	2.35	239	34.8	2.3	278	63.2	1.03	0.947	17.3	0.015	11.8	32.7
8.16	2.88	252	53.4	3.12	291	94.5	2.24	0.954	12.9	0.02	18.3	37.9
8.11	2.39	196	33.8	2.48	227	60.6	1.53	0.956	14.8	0.011	11.1	29.9
7.4	2.89	202	47.4	3.17	232	83.5	2.36	0.949	12.8	0.014	13.3	33.2
7.27	2.38	152	28.8	2.41	176	51.8	1.34	0.946	15.3	0.008	7.34	25.9
6.18	2.89	155	44.4	3.3	179	76.9	2.66	0.936	10.8	0.009	11.8	30.4
6.15	2.4	115	26.6	2.58	132	47.2	1.81	0.946	13.1	0.005	6.1	22.8
5.07	2.06	77.3	18.8	2.25	89.9	33.2	1.55	0.942	11.1	0.002	4.72	18.8
4	1.58	41.5	9.89	1.73	48.9	17.5	1.18	0.942	10	0	2.53	13

Source: Corus Construction (2002). Copyright Corus UK Ltd – reproduced with the kind permission of Corus UK Ltd.

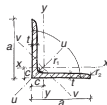

Rolled steel equal angles – dimensions and properties

RSA designation	Mass per metre	Root radius	Toe radius	Distance of centre of gravity	Second moment of area			Radius of gyration			Elastic modulus	D/T	Area of section
					Axis x-x, y-y	Axis u-u	Axis v-v	Axis x-x, y-y	Axis u-u	Axis v-v			
D × B × T		r ₁	r ₂	C _x & C _y	cm ⁴	cm ⁴	cm ⁴	cm	cm	cm	cm ³		A
mm × mm × mm	kg/m	mm	mm	cm	cm ⁴	cm ⁴	cm ⁴	cm	cm	cm	cm ³		cm ²
200 × 200 × 24	71.3	18	4.8	5.85	3356	5322	1391	6.08	7.65	3.91	237	8	90.8
200 × 200 × 20	60.1	18	4.8	5.7	2877	4569	1185	6.13	7.72	3.93	201	10	76.6
200 × 200 × 18	54.4	18	4.8	5.62	2627	4174	1080	6.15	7.76	3.95	183	11	69.4
200 × 200 × 16	48.7	18	4.8	5.54	2369	3765	973	6.18	7.79	3.96	164	13	62
150 × 150 × 18	40.2	16	4.8	4.38	1060	1680	440	4.55	5.73	2.93	99.8	8	51.2
150 × 150 × 15	33.9	16	4.8	4.26	909	1442	375	4.59	5.78	2.95	84.6	10	43.2
150 × 150 × 12	27.5	16	4.8	4.14	748	1187	308	4.62	5.82	2.97	68.9	13	35
150 × 150 × 10	23.1	16	4.8	4.06	635	1008	262	4.64	5.85	2.98	58	15	29.5
120 × 120 × 15	26.7	13	4.8	3.52	448	710	186	3.63	4.57	2.34	52.8	8	34
120 × 120 × 12	21.7	13	4.8	3.41	371	588	153	3.66	4.62	2.35	43.1	10	27.6
120 × 120 × 10	18.3	13	4.8	3.32	316	502	130	3.69	4.64	2.37	36.4	12	23.3
120 × 120 × 8	14.8	13	4.8	3.24	259	411	107	3.71	4.67	2.38	29.5	15	18.8
100 × 100 × 15	21.9	12	4.8	3.02	250	395	105	2.99	3.76	1.94	35.8	7	28
100 × 100 × 12	17.9	12	4.8	2.91	208	330	86.4	3.02	3.81	1.95	29.3	8	22.8
100 × 100 × 10	15.1	12	4.8	2.83	178	283	73.7	3.05	3.84	1.96	24.8	10	19.2
100 × 100 × 8	12.2	12	4.8	2.75	146	232	60.5	3.07	3.86	1.97	20.2	13	15.6
90 × 90 × 12	16	11	4.8	2.66	149	235	62	2.7	3.4	1.75	23.5	8	20.3
90 × 90 × 10	13.5	11	4.8	2.58	128	202	52.9	2.73	3.43	1.76	19.9	9	17.2
90 × 90 × 8	10.9	11	4.8	2.5	105	167	43.4	2.75	3.46	1.77	16.2	11	13.9
90 × 90 × 7	9.6	11	4.8	2.46	93.2	148	38.6	2.76	3.47	1.77	14.2	13	12.3
90 × 90 × 6	8.3	11	4.8	2.41	81	128	33.6	2.76	3.48	1.78	12.3	15	10.6
*80 × 80 × 10	11.9	11	4.8	2.33	87.7	139	36.5	2.4	3.03	1.55	15.5	8	15.2
*80 × 80 × 8	9.7	11	4.8	2.25	72.4	115	30.1	2.42	3.05	1.56	12.6	10	12.3
*80 × 80 × 6	7.4	11	4.8	2.16	56	88.7	23.3	2.44	3.07	1.58	9.6	13	9.4

*70 × 70 × 10	10.3	11	4.8	2.08		57.1	90.3	24	2.08	2.62	1.35	11.6	7	13.2
*70 × 70 × 8	8.4	11	4.8	2		47.4	75	19.7	2.1	2.65	1.36	9.49	9	10.7
*70 × 70 × 6	6.4	11	4.8	1.92		36.8	58.2	15.4	2.12	2.67	1.37	7.24	12	8.2
*60 × 60 × 10	8.8	11	4.8	1.84		34.7	54.7	14.7	1.76	2.21	1.15	8.33	6	11.2
*60 × 60 × 8	7.2	11	4.8	1.76		28.9	45.7	12.1	1.78	2.24	1.15	6.82	8	9.12
*60 × 60 × 6	5.5	11	4.8	1.67		22.6	35.7	9.45	1.8	2.26	1.16	5.21	10	7
*60 × 60 × 5	4.6	11	4.8	1.62		19.2	30.2	8.06	1.8	2.26	1.17	4.37	12	5.91
*50 × 50 × 8	5.9	11	4.8	1.51		16	25.3	6.78	1.46	1.83	0.949	4.59	6	7.52
*50 × 50 × 6	4.6	11	4.8	1.42		12.6	19.9	5.28	1.47	1.85	0.954	3.52	8	5.8
*50 × 50 × 5	3.9	11	4.8	1.37		10.7	16.9	4.51	1.48	1.86	0.958	2.95	10	4.91
*50 × 50 × 4	3.1	11	4.8	1.32		8.72	13.7	3.71	1.48	1.85	0.963	2.37	13	4
*50 × 50 × 3	2.4	11	4.8	1.25		6.6	10.3	2.88	1.47	1.83	0.968	1.76	17	3.07
*45 × 45 × 6	4.1	11	4.8	1.3		8.95	14.1	3.76	1.31	1.65	0.851	2.8	8	5.2
*45 × 45 × 5	3.5	11	4.8	1.25		7.63	12	3.21	1.32	1.65	0.853	2.35	9	4.41
*45 × 45 × 4	2.8	11	4.8	1.2		6.22	9.79	2.65	1.31	1.65	0.857	1.88	11	3.6
*45 × 45 × 3	2.2	11	4.8	1.13		4.71	7.37	2.05	1.3	1.63	0.86	1.4	15	2.77
*40 × 40 × 6	3.6	11	4.8	1.18		6.1	9.63	2.57	1.15	1.45	0.747	2.16	7	4.6
*40 × 40 × 5	3.1	11	4.8	1.13		5.21	8.22	2.19	1.15	1.45	0.748	1.81	8	3.91
*40 × 40 × 4	2.5	11	4.8	1.08		4.25	6.7	1.8	1.15	1.45	0.75	1.45	10	3.2
*40 × 40 × 3	1.9	11	4.8	1.01		3.22	5.04	1.4	1.14	1.43	0.752	1.08	13	2.47
*30 × 30 × 5	2.3	11	4.8	0.89		2.02	3.19	0.846	0.832	1.05	0.539	0.956	6	2.91
*30 × 30 × 4	1.9	11	4.8	0.84		1.65	2.61	0.691	0.829	1.04	0.536	0.764	8	2.4
*30 × 30 × 3	1.5	11	4.8	0.78		1.25	1.96	0.53	0.816	1.02	0.532	0.561	10	1.87
*25 × 25 × 5	1.9	11	4.8	0.78		1.09	1.72	0.462	0.673	0.846	0.438	0.634	5	2.41
*25 × 25 × 4	1.6	11	4.8	0.73		0.894	1.42	0.372	0.668	0.841	0.431	0.504	6	2
*25 × 25 × 3	1.2	11	4.8	0.67		0.672	1.06	0.281	0.654	0.823	0.423	0.367	8	1.57

+British Standard sections not produced by Corus.

Source: Corus Construction (2002). Copyright Corus UK Ltd – reproduced with the kind permission of Corus UK Ltd.

Rolled steel unequal angles – dimensions and properties

RSA designation <i>D × B × T</i>	Mass per metre	Root radius <i>r1</i>	Toe radius <i>r2</i>	Distance of centre of gravity <i>Cx</i>	Distance of centre of gravity <i>Cy</i>	Angle <i>x-x</i> to <i>u-u</i> axis <i>Tan a</i>	Second moment of area	
							Axis <i>x-x</i> <i>cm⁴</i>	Axis <i>y-y</i> <i>cm⁴</i>
200 × 150 × 18	47.2	15	4.8	6.34	3.86	0.549	2390	1155
200 × 150 × 15	39.7	15	4.8	6.22	3.75	0.551	2037	989
200 × 150 × 12	32.1	15	4.8	6.1	3.63	0.553	1667	812
200 × 100 × 15	33.9	15	4.8	7.17	2.23	0.26	1772	303
200 × 100 × 12	27.4	15	4.8	7.04	2.11	0.263	1454	251
200 × 100 × 10	23.1	15	4.8	6.95	2.03	0.265	1233	215
150 × 90 × 15	26.7	12	4.8	5.21	2.24	0.354	764	207
150 × 90 × 12	21.6	12	4.8	5.09	2.12	0.359	630	172
150 × 90 × 10	18.2	12	4.8	5	2.04	0.361	536	147
150 × 75 × 15	24.9	11	4.8	5.53	1.81	0.254	715	120
150 × 75 × 12	20.2	11	4.8	5.41	1.7	0.259	591	100
150 × 75 × 10	17	11	4.8	5.32	1.62	0.262	503	86.3
125 × 75 × 12	17.8	11	4.8	4.31	1.84	0.354	355	96
125 × 75 × 10	15	11	4.8	4.23	1.76	0.358	303	82.5
125 × 75 × 8	12.2	11	4.8	4.14	1.68	0.36	249	68.1
100 × 75 × 12	15.4	10	4.8	3.27	2.03	0.54	189	90.3
100 × 75 × 10	13	10	4.8	3.19	1.95	0.544	162	77.7
100 × 75 × 8	10.6	10	4.8	3.1	1.87	0.547	133	64.2
100 × 65 × 10	12.3	10	4.8	3.36	1.63	0.41	154	51.1
100 × 65 × 8	10	10	4.8	3.28	1.56	0.414	127	42.3
100 × 65 × 7	8.8	10	4.8	3.23	1.51	0.415	113	37.7
*80 × 60 × 8	8.3	8	4.8	2.55	1.56	0.544	65.8	31.5
*80 × 60 × 7	7.3	8	4.8	2.5	1.52	0.545	58.5	28.1
*80 × 60 × 6	6.3	8	4.8	2.46	1.48	0.546	50.9	24.5
*75 × 50 × 8	7.4	7	2.4	2.53	1.29	0.43	52.4	18.6
*75 × 50 × 6	5.7	7	2.4	2.44	1.21	0.436	40.9	14.6
*65 × 50 × 8	6.8	6	2.4	2.12	1.37	0.569	34.9	17.8
*65 × 50 × 6	5.2	6	2.4	2.04	1.3	0.575	27.4	14.1
*65 × 50 × 5	4.4	6	2.4	2	1.26	0.577	23.3	12
*60 × 30 × 6	4	6	2.4	2.2	0.72	0.252	18.3	3.05
*60 × 30 × 5	3.4	6	2.4	2.16	0.68	0.256	15.7	2.64
*40 × 25 × 4	1.9	4	2.4	1.36	0.62	0.38	3.86	1.15

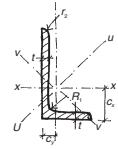

Second moment of area		Radius of gyration				Elastic modulus		D/T	Area of section A
Axis u-u	Axis v-v	Axis x-x	Axis y-y	Axis u-u	Axis v-v	Axis x-x	Axis y-y		
cm ⁴	cm ⁴	cm	cm	cm	cm	cm ³	cm ³	cm ²	
2922	623	6.3	4.38	6.97	3.22	175	104	11	60.1
2495	531	6.34	4.42	7.02	3.24	148	87.8	13	50.6
2044	435	6.38	4.45	7.07	3.26	120	71.4	17	40.9
1879	197	6.41	2.65	6.6	2.13	138	39	13	43.1
1544	162	6.45	2.68	6.65	2.15	112	31.9	17	34.9
1310	138	6.48	2.7	6.68	2.17	94.5	26.9	20	29.4
844	127	4.74	2.47	4.99	1.93	78	30.6	10	34
698	104	4.78	2.5	5.03	1.95	63.6	25	13	27.6
595	89.1	4.81	2.52	5.06	1.96	53.6	21.2	15	23.2
756	79.2	4.75	1.95	4.89	1.58	75.5	21.1	10	31.7
626	65.2	4.79	1.98	4.93	1.59	61.6	17.3	13	25.7
534	55.7	4.82	2	4.96	1.6	52	14.7	10	21.7
392	58.8	3.95	2.06	4.16	1.61	43.4	17	10	22.7
336	50.2	3.98	2.08	4.18	1.62	36.7	14.4	13	19.2
275	41.2	4	2.09	4.21	1.63	29.7	11.7	16	15.5
230	49.5	3.1	2.14	3.42	1.59	28.1	16.5	8	19.7
197	42.2	3.12	2.16	3.45	1.59	23.8	14	10	16.6
163	34.7	3.14	2.18	3.48	1.61	19.3	11.4	13	13.5
175	30.2	3.14	1.81	3.35	1.39	23.2	10.5	10	15.6
144	24.9	3.17	1.83	3.38	1.4	18.9	8.56	13	12.7
128	22.1	3.18	1.84	3.39	1.41	16.6	7.56	14	11.2
80.2	17.1	2.49	1.72	2.75	1.27	12.1	7.09	10	10.6
71.4	15.2	2.5	1.73	2.76	1.27	10.6	6.26	11	9.35
62.2	13.2	2.51	1.74	2.77	1.28	9.19	5.41	13	8.08
60.1	10.9	2.36	1.4	2.52	1.07	10.5	5	9	9.44
47.1	8.48	2.38	1.42	2.55	1.08	8.1	3.86	13	7.22
43.1	9.62	2.01	1.44	2.24	1.06	7.97	4.92	8	8.61
34	7.49	2.04	1.46	2.27	1.07	6.14	3.8	11	6.59
29	6.38	2.05	1.47	2.28	1.07	5.18	3.21	13	5.55
19.3	2.01	1.9	0.774	1.95	0.629	4.82	1.34	10	5.09
16.6	1.72	1.91	0.783	1.96	0.632	4.08	1.14	12	4.3
4.32	0.692	1.26	0.685	1.33	0.532	1.46	0.612	10	2.45

+British Standard sections not produced by Corus.

Source: Corus Construction (2002). Copyright Corus UK Ltd – reproduced with the kind permission of Corus UK Ltd.

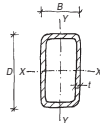

Hot finished rectangular hollow sections – dimensions and properties

RHS designation		Mass per metre	Area of section	Ratios for local buckling		Second moment of area		Radius of gyration		Elastic modulus		Plastic modulus		Torsional constants		Surface area of section	Approx length per tonne
Size	Thickness			Flange	Web	Axis x-x	Axis y-y	Axis x-x	Axis y-y	Axis x-x	Axis y-y	Axis x-x	Axis y-y	J	C		
D×B	T	A	b/t	d/t	I _x	I _y	r _x	r _y	Z _x	Z _y	S _x	S _y	J	C			
mm×mm	mm	kg/m	cm ²		cm ⁴	cm ⁴	cm	cm	cm ³	cm ³	cm ³	cm ³	cm ⁴	cm ³	m ² /m	m	
50×30	2.5	2.89	3.68	9	17	11.8	5.22	1.79	1.19	4.73	3.48	5.92	4.11	11.7	5.73	0.154	346
50×30	3	3.41	4.34	7	13.7	13.6	5.94	1.77	1.17	5.43	3.96	6.88	4.76	13.5	6.51	0.152	293
50×30	3.2	3.61	4.6	6.37	12.6	14.2	6.2	1.76	1.16	5.68	4.13	7.25	5	14.2	6.8	0.152	277
50×30	3.6	4.01	5.1	5.33	10.9	15.4	6.67	1.74	1.14	6.16	4.45	7.94	5.46	15.4	7.31	0.151	250
50×30	4	4.39	5.59	4.5	9.5	16.5	7.08	1.72	1.13	6.6	4.72	8.59	5.88	16.6	7.77	0.15	228
50×30	5	5.28	6.73	3	7	18.7	7.89	1.67	1.08	7.49	5.26	10	6.8	19	8.67	0.147	189
60×40	2.5	3.68	4.68	13	21	22.8	12.1	2.21	1.6	7.61	6.03	9.32	7.02	25.1	9.73	0.194	272
60×40	3	4.35	5.54	10.3	17	26.5	13.9	2.18	1.58	8.82	6.95	10.9	8.19	29.2	11.2	0.192	230
60×40	3.2	4.62	5.88	9.5	15.7	27.8	14.6	2.18	1.57	9.27	7.29	11.5	8.64	30.8	11.7	0.192	217
60×40	3.6	5.14	6.54	8.11	13.7	30.4	15.9	2.16	1.56	10.1	7.93	12.7	9.5	33.8	12.8	0.191	195
60×40	4	5.64	7.19	7	12	32.8	17	2.14	1.54	10.9	8.52	13.8	10.3	36.7	13.7	0.19	177
60×40	5	6.85	8.73	5	9	38.1	19.5	2.09	1.5	12.7	9.77	16.4	12.2	43	15.7	0.187	146
60×40	6	7.99	10.2	3.67	7	42.3	21.4	2.04	1.45	14.1	10.7	18.6	13.7	48.2	17.3	0.185	125
60×40	6.3	8.31	10.6	3.35	6.52	43.4	21.9	2.02	1.44	14.5	11	19.2	14.2	49.5	17.6	0.184	120
80×40	3	5.29	6.74	10.3	23.7	54.2	18	2.84	1.63	13.6	9	17.1	10.4	43.8	15.3	0.232	189
80×40	3.2	5.62	7.16	9.5	22	57.2	18.9	2.83	1.63	14.3	9.46	18	11	46.2	16.1	0.232	178
80×40	3.6	6.27	7.98	8.11	19.2	62.8	20.6	2.81	1.61	15.7	10.3	20	12.1	50.8	17.5	0.231	160
80×40	4	6.9	8.79	7	17	68.2	22.2	2.79	1.59	17.1	11.1	21.8	13.2	55.2	18.9	0.23	145
80×40	5	8.42	10.7	5	13	80.3	25.7	2.74	1.55	20.1	12.9	26.1	15.7	65.1	21.9	0.227	119
80×40	6	9.87	12.6	3.67	10.3	90.5	28.5	2.68	1.5	22.6	14.2	30	17.8	73.4	24.2	0.225	101
80×40	6.3	10.3	13.1	3.35	9.7	93.3	29.2	2.67	1.49	23.3	14.6	31.1	18.4	75.6	24.8	0.224	97.2
80×40	8	12.5	16	2	7	106	32.1	2.58	1.42	26.5	16.1	36.5	21.2	85.8	27.4	0.219	79.9

76.2×50.8	3	5.62	7.16	13.9	22.4	56.7	30	2.81	2.05	14.9	11.8	18.2	13.7	62.1	19.1	0.246	178
76.2×50.8	3.2	5.97	7.61	12.9	20.8	59.8	31.6	2.8	2.04	15.7	12.4	19.2	14.5	65.7	20.1	0.246	167
76.2×50.8	3.6	6.66	8.49	11.1	18.2	65.8	34.6	2.78	2.02	17.3	13.6	21.3	16	72.5	22	0.245	150
76.2×50.8	4	7.34	9.35	9.7	16.1	71.5	37.5	2.77	2	18.8	14.8	23.3	17.5	79.1	23.8	0.244	136
76.2×50.8	5	8.97	11.4	7.16	12.2	84.4	43.9	2.72	1.96	22.2	17.3	28	20.9	94.2	27.8	0.241	111
76.2×50.8	6	10.5	13.4	5.47	9.7	95.6	49.2	2.67	1.91	25.1	19.4	32.2	23.9	108	31.2	0.239	95
76.2×50.8	6.3	11	14	5.06	9.1	98.6	50.6	2.66	1.9	25.9	19.9	33.4	24.8	111	32	0.238	91.1
76.2×50.8	8	13.4	17.1	3.35	6.53	113	57	2.57	1.83	29.6	22.4	39.4	29	129	36.1	0.233	74.6
90×50	3	6.24	7.94	13.7	27	84.4	33.5	3.26	2.05	18.8	13.4	23.2	15.3	76.5	22.4	0.272	160
90×50	3.2	6.63	8.44	12.6	25.1	89.1	35.3	3.25	2.04	19.8	14.1	24.6	16.2	80.9	23.6	0.272	151
90×50	3.6	7.4	9.42	10.9	22	98.3	38.7	3.23	2.03	21.8	15.5	27.2	18	89.4	25.9	0.271	135
90×50	4	8.15	10.4	9.5	19.5	107	41.9	3.21	2.01	23.8	16.8	29.8	19.6	97.5	28	0.27	123
90×50	5	9.99	12.7	7	15	127	49.2	3.16	1.97	28.3	19.7	36	23.5	116	32.9	0.267	100
90×50	6	11.8	15	5.33	12	145	55.4	3.11	1.92	32.2	22.1	41.6	27	133	37	0.265	85.1
90×50	6.3	12.3	15.6	4.94	11.3	150	57	3.1	1.91	33.3	22.8	43.2	28	138	38.1	0.264	81.5
90×50	8	15	19.2	3.25	8.25	174	64.6	3.01	1.84	38.6	25.8	51.4	32.9	160	43.2	0.259	66.5
100×50	3	6.71	8.54	13.7	30.3	110	36.8	3.58	2.08	21.9	14.7	27.3	16.8	88.4	25	0.292	149
100×50	3.2	7.13	9.08	12.6	28.3	116	38.8	3.57	2.07	23.2	15.5	28.9	17.7	93.4	26.4	0.292	140
100×50	3.6	7.96	10.1	10.9	24.8	128	42.6	3.55	2.05	25.6	17	32.1	19.6	103	29	0.291	126
100×50	4	8.78	11.2	9.5	22	140	46.2	3.53	2.03	27.9	18.5	35.2	21.5	113	31.4	0.29	114
100×50	5	10.8	13.7	7	17	167	54.3	3.48	1.99	33.3	21.7	42.6	25.8	135	36.9	0.287	92.8
100×50	6	12.7	16.2	5.33	13.7	190	61.2	3.43	1.95	38.1	24.5	49.4	29.7	154	41.6	0.285	78.8
100×50	6.3	13.3	16.9	4.94	12.9	197	63	3.42	1.93	39.4	25.2	51.3	30.8	160	42.9	0.284	75.4
100×50	8	16.3	20.8	3.25	9.5	230	71.7	3.33	1.86	46	28.7	61.4	36.3	186	48.9	0.279	61.4
100×60	3	7.18	9.14	17	30.3	124	55.7	3.68	2.47	24.7	18.6	30.2	21.2	121	30.7	0.312	139
100×60	3.2	7.63	9.72	15.7	28.3	131	58.8	3.67	2.46	26.2	19.6	32	22.4	129	32.4	0.312	131
100×60	3.6	8.53	10.9	13.7	24.8	145	64.8	3.65	2.44	28.9	21.6	35.6	24.9	142	35.6	0.311	117
100×60	4	9.41	12	12	22	158	70.5	3.63	2.43	31.6	23.5	39.1	27.3	156	38.7	0.31	106
100×60	5	11.6	14.7	9	17	189	83.6	3.58	2.38	37.8	27.9	47.4	32.9	188	45.9	0.307	86.5
100×60	6	13.6	17.4	7	13.7	217	95	3.53	2.34	43.4	31.7	55.1	38.1	216	52.1	0.305	73.3
100×60	6.3	14.2	18.1	6.52	12.9	225	98.1	3.52	2.33	45	32.7	57.3	39.5	224	53.8	0.304	70.2
100×60	8	17.5	22.4	4.5	9.5	264	113	3.44	2.25	52.8	37.8	68.7	47.1	265	62.2	0.299	57
120×60	3.6	9.66	12.3	13.7	30.3	227	76.3	4.3	2.49	37.9	25.4	47.2	28.9	183	43.3	0.351	104
120×60	4	10.7	13.6	12	27	249	83.1	4.28	2.47	41.5	27.7	51.9	31.7	201	47.1	0.35	93.7
120×60	5	13.1	16.7	9	21	299	98.8	4.23	2.43	49.9	32.9	63.1	38.4	242	56	0.347	76.1
120×60	6	15.5	19.8	7	17	345	113	4.18	2.39	57.5	37.5	73.6	44.5	279	63.8	0.345	64.4
120×60	6.3	16.2	20.7	6.52	16	358	116	4.16	2.37	59.7	38.8	76.7	46.3	290	65.9	0.344	61.6
120×60	8	20.1	25.6	4.5	12	425	135	4.08	2.3	70.8	45	92.7	55.4	344	76.6	0.339	49.9

Source: Corus Construction (2002). Copyright Corus UK Ltd – reproduced with the kind permission of Corus UK Ltd.

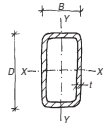

Hot finished rectangular hollow sections – dimensions and properties

RHS designation		Mass per metre	Area of section	Ratios for local buckling		Second moment of area		Radius of gyration		Elastic modulus		Plastic modulus		Torsional constants		Surface area of section	Approx length per tonne
Size	Thickness			Flange	Web	Axis x-x	Axis y-y	Axis x-x	Axis y-y	Axis x-x	Axis y-y	Axis x-x	Axis y-y	J	C		
$D \times B$	T		A	b/t	d/t	I_x	I_y	r_x	r_y	Z_x	Z_y	S_x	S_y				
mm × mm	mm	kg/m	cm ²			cm ⁴	cm ⁴	cm	cm	cm ³	cm ³	cm ³	cm ³	cm ⁴	cm ³	m ² /m	m
120 × 80	3.6	10.8	13.7	19.2	30.3	276	147	4.48	3.27	46	36.7	55.6	42	301	59.5	0.391	92.7
120 × 80	4	11.9	15.2	17	27	303	161	4.46	3.25	50.4	40.2	61.2	46.1	330	65	0.39	83.9
120 × 80	5	14.7	18.7	13	21	365	193	4.42	3.21	60.9	48.2	74.6	56.1	401	77.9	0.387	68
120 × 80	6	17.4	22.2	10.3	17	423	222	4.37	3.17	70.6	55.6	87.3	65.5	468	89.6	0.385	57.5
120 × 80	6.3	18.2	23.2	9.7	16	440	230	4.36	3.15	73.3	57.6	91	68.2	487	92.9	0.384	54.9
120 × 80	8	22.6	28.8	7	12	525	273	4.27	3.08	87.5	68.1	111	82.6	587	110	0.379	44.3
120 × 80	10	27.4	34.9	5	9	609	313	4.18	2.99	102	78.1	131	97.3	688	126	0.374	36.5
150 × 100	4	15.1	19.2	22	34.5	607	324	5.63	4.11	81	64.8	97.4	73.6	660	105	0.49	66.4
150 × 100	5	18.6	23.7	17	27	739	392	5.58	4.07	98.5	78.5	119	90.1	807	127	0.487	53.7
150 × 100	6	22.1	28.2	13.7	22	862	456	5.53	4.02	115	91.2	141	106	946	147	0.485	45.2
150 × 100	6.3	23.1	29.5	12.9	20.8	898	474	5.52	4.01	120	94.8	147	110	986	153	0.484	43.2
150 × 100	8	28.9	36.8	9.5	15.8	1087	569	5.44	3.94	145	114	180	135	1203	183	0.479	34.7
150 × 100	10	35.3	44.9	7	12	1282	665	5.34	3.85	171	133	216	161	1432	214	0.474	28.4
150 × 100	12	41.4	52.7	5.33	9.5	1450	745	5.25	3.76	193	149	249	185	1633	240	0.469	24.2
150 × 100	12.5	42.8	54.6	5	9	1488	763	5.22	3.74	198	153	256	190	1679	246	0.468	23.3
160 × 80	4	14.4	18.4	17	37	612	207	5.77	3.35	76.5	51.7	94.7	58.3	493	88.1	0.47	69.3
160 × 80	5	17.8	22.7	13	29	744	249	5.72	3.31	93	62.3	116	71.1	600	106	0.467	56
160 × 80	6	21.2	27	10.3	23.7	868	288	5.67	3.27	108	72	136	83.3	701	122	0.465	47.2
160 × 80	6.3	22.2	28.2	9.7	22.4	903	299	5.66	3.26	113	74.8	142	86.8	730	127	0.464	45.1
160 × 80	8	27.6	35.2	7	17	1091	356	5.57	3.18	136	89	175	106	883	151	0.459	36.2
160 × 80	10	33.7	42.9	5	13	1284	411	5.47	3.1	161	103	209	125	1041	175	0.454	29.7
160 × 80	12	39.5	50.3	3.67	10.3	1449	455	5.37	3.01	181	114	240	142	1175	194	0.449	25.3
160 × 80	12.5	40.9	52.1	3.4	9.8	1485	465	5.34	2.99	186	116	247	146	1204	198	0.448	24.5

200 × 100	5	22.6	28.7	17	37	1495	505	7.21	4.19	149	101	185	114	1204	172	0.587	44.3
200 × 100	6	26.8	34.2	13.7	30.3	1754	589	7.16	4.15	175	118	218	134	1414	200	0.585	37.3
200 × 100	6.3	28.1	35.8	12.9	28.7	1829	613	7.15	4.14	183	123	228	140	1475	208	0.584	35.6
200 × 100	8	35.1	44.8	9.5	22	2234	739	7.06	4.06	223	148	282	172	1804	251	0.579	28.5
200 × 100	10	43.1	54.9	7	17	2664	869	6.96	3.90	266	174	341	206	2156	295	0.574	23.2
200 × 100	12	50.8	64.7	5.33	13.7	3047	979	6.86	3.89	305	196	395	237	2469	333	0.569	19.7
200 × 100	12.5	52.7	67.1	5	13	3136	1004	6.84	3.87	314	201	408	245	2541	341	0.568	19
250 × 150	5	30.4	38.7	27	47	3360	1527	9.31	6.28	269	204	324	228	3278	337	0.787	32.9
250 × 150	6	36.2	46.2	22	38.7	3965	1796	9.27	6.24	317	239	385	270	3787	396	0.785	27.6
250 × 150	6.3	38	48.4	20.8	36.7	4143	1874	9.25	6.22	331	250	402	283	4054	413	0.784	26.3
250 × 150	8	47.7	60.8	15.8	28.3	5111	2298	9.17	6.15	409	306	501	350	5021	506	0.779	21
250 × 150	10	58.8	74.9	12	22	6174	2755	9.08	6.06	494	367	611	426	6090	605	0.774	17
250 × 150	12	69.6	88.7	9.5	17.8	7154	3168	8.98	5.98	572	422	715	497	7088	695	0.769	14.4
250 × 150	12.5	72.3	92.1	9	17	7387	3265	8.96	5.96	591	435	740	514	7326	717	0.768	13.8
250 × 150	16	90.3	115	6.38	12.6	8879	3873	8.79	5.8	710	516	906	625	8868	849	0.759	11.1
300 × 200	5	38.3	48.7	37	57	6322	3396	11.4	8.35	421	340	501	380	6824	552	0.987	26.1
300 × 200	6	45.7	58.2	30.3	47	7486	4013	11.3	8.31	499	401	596	451	8100	651	0.985	21.9
300 × 200	6.3	47.9	61	28.7	44.6	7829	4193	11.3	8.29	522	419	624	472	8476	681	0.984	20.9
300 × 200	8	60.3	76.8	22	34.5	9717	5184	11.3	8.22	648	518	779	589	10560	840	0.979	16.6
300 × 200	10	74.5	94.9	17	27	11820	6278	11.2	8.13	788	628	956	721	12910	1015	0.974	13.4
300 × 200	12	88.5	113	13.7	22	13800	7294	11.1	8.05	920	729	1124	847	15140	1178	0.969	11.3
300 × 200	12.5	91.9	117	13	21	14270	7537	11	8.02	952	754	1165	877	15680	1217	0.968	10.9
300 × 200	16	115	147	9.5	15.8	17390	9109	10.9	7.87	1159	911	1441	1080	19250	1468	0.959	8.67
400 × 200	6	55.1	70.2	30.3	63.7	15000	5142	14.6	8.56	750	514	917	568	12050	877	1.18	18.2
400 × 200	6.3	57.8	73.6	28.7	60.5	15700	5376	14.6	8.55	785	538	960	594	12610	917	1.18	17.3
400 × 200	8	72.8	92.8	22	47	19560	6660	14.5	8.47	978	666	1203	743	15730	1135	1.18	13.7
400 × 200	10	90.2	115	17	37	23910	8084	14.4	8.39	1196	808	1480	911	19260	1376	1.17	11.1
400 × 200	12	107	137	13.7	30.3	28060	9418	14.3	8.3	1403	942	1748	1072	22620	1602	1.17	9.32
400 × 200	12.5	112	142	13	29	29060	9738	14.3	8.28	1453	974	1813	1111	23440	1656	1.17	8.97
400 × 200	16	141	179	9.5	22	35740	11820	14.1	8.13	1787	1182	2256	1374	28870	2010	1.16	7.12
450 × 250	8	85.4	109	28.3	53.3	30080	12140	16.6	10.6	1337	971	1622	1081	27080	1629	1.38	11.7
450 × 250	10	106	135	22	42	36890	14820	16.5	10.5	1640	1185	2000	1331	33280	1986	1.37	9.44
450 × 250	12	126	161	17.8	34.5	43430	17360	16.4	10.4	1930	1389	2367	1572	39260	2324	1.37	7.93
450 × 250	12.5	131	167	17	33	45030	17970	16.4	10.4	2001	1438	2458	1631	40720	2406	1.37	7.62
450 × 250	16	166	211	12.6	25.1	55710	22040	16.2	10.2	2476	1763	3070	2029	50550	2947	1.36	6.04
500 × 300	8	97.9	125	34.5	59.5	43730	19950	18.7	12.6	1749	1330	2100	1480	42560	2203	1.58	10.2
500 × 300	10	122	155	27	47	53760	24440	18.6	12.6	2150	1629	2595	1826	52450	2696	1.57	8.22
500 × 300	12	145	185	22	38.7	63450	28740	18.5	12.5	2538	1916	3077	2161	62040	3167	1.57	6.9
500 × 300	12.5	151	192	21	37	65810	29780	18.5	12.5	2633	1985	3196	2244	64390	3281	1.57	6.63
500 × 300	16	191	243	15.8	28.3	81780	36770	18.3	12.3	3271	2451	4005	2804	80330	4044	1.56	5.24

Source: Corus Construction (2002). Copyright Corus UK Ltd – reproduced with the kind permission of Corus UK Ltd.

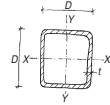

Hot finished square hollow sections – dimensions and properties

SHS designation		Mass per metre kg/m	Area of section A cm ²	Ratios for local buckling		Second moment of area I cm ⁴	Radius of gyration r cm	Elastic modulus Z cm ³	Plastic modulus S cm ³	Torsional constants		Surface area of section m ² /m	Approx length per tonne m
Size D × B mm × mm	Thickness T mm			Flange b/t	Web d/t					J cm ⁴	C cm ³		
40 × 40	2.5	2.89	3.68	13	13	8.54	1.52	4.27	5.14	13.6	6.22	0.154	346
40 × 40	3	3.41	4.34	10.3	10.3	9.78	1.5	4.89	5.97	15.7	7.1	0.152	293
40 × 40	3.2	3.61	4.6	9.5	9.5	40.2	1.49	5.11	6.28	16.5	7.42	0.152	277
40 × 40	3.6	4.01	5.1	8.11	8.11	11.1	1.47	5.54	6.88	18.1	8.01	0.151	250
40 × 40	4	4.39	5.59	7	7	11.8	1.45	5.91	7.44	19.5	8.54	0.15	228
40 × 40	5	5.28	6.73	5	5	13.4	1.41	6.68	8.66	22.5	9.6	0.147	189
50 × 50	2.5	3.68	4.68	17	17	17.5	1.93	6.99	8.29	27.5	10.2	0.194	272
50 × 50	3	4.35	5.54	13.7	13.7	20.2	1.91	8.08	9.7	32.1	11.8	0.192	230
50 × 50	3.2	4.62	5.88	12.6	12.6	21.2	1.9	8.49	10.2	33.8	12.4	0.192	217
50 × 50	3.6	5.14	6.54	10.9	10.9	23.2	1.88	9.27	11.3	37.2	13.5	0.191	195
50 × 50	4	5.64	7.19	9.5	9.5	25	1.86	9.99	12.3	40.4	14.5	0.19	177
50 × 50	5	6.85	8.73	7	7	28.9	1.82	11.6	14.5	47.6	16.7	0.187	146
50 × 50	6	7.99	40.2	5.33	5.33	32	1.77	12.8	16.5	53.6	18.4	0.185	125
50 × 50	6.3	8.31	10.6	4.94	4.94	32.8	1.76	13.1	17	55.2	18.8	0.184	120
60 × 60	3	5.29	6.74	17	17	36.2	2.32	12.1	14.3	56.9	17.7	0.232	189
60 × 60	3.2	5.62	7.16	15.7	15.7	38.2	2.31	12.7	15.2	60.2	18.6	0.232	178
60 × 60	3.6	6.27	7.98	13.7	13.7	41.9	2.29	14	16.8	66.5	20.4	0.231	160
60 × 60	4	6.9	8.79	12	12	45.4	2.27	15.1	18.3	72.5	22	0.23	145
60 × 60	5	8.42	10.7	9	9	53.3	2.23	17.8	21.9	86.4	25.7	0.227	119
60 × 60	6	9.87	12.6	7	7	59.9	2.18	20	25.1	98.6	28.8	0.225	101
60 × 60	6.3	10.3	13.1	6.52	6.52	61.6	2.17	20.5	26	102	29.6	0.224	97.2
60 × 60	8	12.5	16	4.5	4.5	69.7	2.09	23.2	30.4	118	33.4	0.219	79.9
70 × 70	3	6.24	7.94	20.3	20.3	59	2.73	16.9	19.9	92.2	24.8	0.272	160
70 × 70	3.2	6.63	8.44	18.9	18.9	62.3	2.72	17.8	21	97.6	26.1	0.272	151
70 × 70	3.6	7.4	9.42	16.4	16.4	68.6	2.7	19.6	23.3	108	28.7	0.271	135
70 × 70	4	8.15	10.4	14.5	14.5	74.7	2.68	21.3	25.5	118	31.2	0.27	123
70 × 70	5	9.99	12.7	11	11	88.5	2.64	25.3	30.8	142	36.8	0.267	400
70 × 70	6	11.8	15	8.67	8.67	401	2.59	28.7	35.5	163	41.6	0.265	85.1
70 × 70	6.3	12.3	15.6	8.11	8.11	104	2.58	29.7	36.9	169	42.9	0.264	81.5
70 × 70	8	15	19.2	5.75	5.75	120	2.5	34.2	43.8	200	49.2	0.259	66.5
80 × 80	3.2	7.63	9.72	22	22	95	3.13	23.7	27.9	148	34.9	0.312	131
80 × 80	3.6	8.53	10.9	19.2	19.2	105	3.11	26.2	31	164	38.5	0.311	117
80 × 80	4	9.41	12	17	17	114	3.09	28.6	34	180	41.9	0.31	406
80 × 80	5	11.6	14.7	13	13	137	3.05	34.2	41.1	217	49.8	0.307	86.5
80 × 80	6	13.6	17.4	10.3	10.3	156	3	39.1	47.8	252	56.8	0.305	73.3
80 × 80	6.3	14.2	18.1	9.7	9.7	162	2.99	40.5	49.7	262	58.7	0.304	70.2
80 × 80	8	17.5	22.4	7	7	189	2.91	47.3	59.5	312	68.3	0.299	57
90 × 90	3.6	9.66	12.3	22	22	152	3.52	33.8	39.7	237	49.7	0.351	104
90 × 90	4	10.7	13.6	19.5	19.5	166	3.5	37	43.6	260	54.2	0.35	93.7
90 × 90	5	13.1	16.7	15	15	200	3.45	44.4	53	316	64.8	0.347	76.1
90 × 90	6	15.5	19.8	12	12	230	3.41	51.1	61.8	367	74.3	0.345	64.4
90 × 90	6.3	16.2	20.7	11.3	11.3	238	3.4	53	64.3	382	77	0.344	61.6
90 × 90	8	20.1	25.6	8.25	8.25	281	3.32	62.6	77.6	459	90.5	0.339	49.9
100 × 100	3.6	10.8	13.7	24.8	24.8	212	3.92	42.3	49.5	328	62.3	0.391	92.7
100 × 100	4	11.9	15.2	22	22	232	3.91	46.4	54.4	361	68.2	0.389	83.9
100 × 100	5	14.7	18.7	17	17	279	3.86	55.9	66.4	439	81.8	0.387	68
100 × 100	6	17.4	22.2	13.7	13.7	323	3.82	64.6	77.6	513	94.3	0.385	57.5
100 × 100	6.3	18.2	23.2	12.9	12.9	336	3.8	67.1	80.9	534	97.8	0.384	54.9
100 × 100	8	22.6	28.8	9.5	9.5	400	3.73	79.9	98.2	646	116	0.379	44.3
100 × 100	10	27.4	34.9	7	7	462	3.64	92.4	116	761	133	0.374	36.5

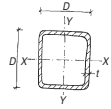

SHS designation		Mass per metre kg/m	Area of section A cm ²	Ratios for local buckling		Second moment of area I cm ⁴	Radius of gyration r cm	Elastic modulus Z cm ³	Plastic modulus S cm ³	Torsional constants		Surface area of section m ² /m	Approx length per tonne m
Size D × B mm × mm	Thickness T mm			Flange b/t	Web d/t					J cm ⁴	C cm ³		
120 × 120	4	14.4	18.4	27	27	410	4.72	68.4	79.7	635	101	0.47	69.3
120 × 120	5	47.8	22.7	21	21	498	4.68	83	97.6	777	122	0.467	56
120 × 120	6	21.2	27	17	17	579	4.63	96.6	115	911	141	0.465	47.2
120 × 120	6.3	22.2	28.2	16	16	603	4.62	100	120	950	147	0.464	45.1
120 × 120	8	27.6	35.2	12	12	726	4.55	121	146	1160	176	0.459	36.2
120 × 120	10	33.7	42.9	9	9	852	4.46	142	175	1382	206	0.454	29.7
120 × 120	12	39.5	50.3	7	7	958	4.36	160	201	1578	230	0.449	25.3
120 × 120	12.5	40.9	52.1	6.6	6.6	982	4.34	164	207	1623	236	0.448	24.5
140 × 140	5	21	26.7	25	25	807	5.5	115	135	1253	170	0.547	47.7
140 × 140	6	24.9	31.8	20.3	20.3	944	5.45	135	159	1475	198	0.545	40.1
140 × 140	6.3	26.1	33.3	19.2	19.2	984	5.44	141	166	1540	206	0.544	38.3
140 × 140	8	32.6	41.6	14.5	14.5	1195	5.36	171	204	1892	249	0.539	30.7
140 × 140	10	40	50.9	11	11	1416	5.27	202	246	2272	294	0.534	25
140 × 140	12	47	59.9	8.67	8.67	1609	5.18	230	284	2616	333	0.529	21.3
140 × 140	12.5	48.7	62.1	8.2	8.2	1653	5.16	236	293	2696	342	0.528	20.5
150 × 150	5	22.6	28.7	27	27	1002	5.9	134	156	1550	197	0.587	44.3
150 × 150	6	26.8	34.2	22	22	1174	5.86	156	184	1828	230	0.585	37.3
150 × 150	6.3	28.1	35.8	20.8	20.8	1223	5.85	163	192	1909	240	0.584	35.6
150 × 150	8	35.1	44.8	15.8	15.8	1491	5.77	199	237	2351	291	0.579	28.5
150 × 150	10	43.1	54.9	12	12	1773	5.68	236	286	2832	344	0.574	23.2
150 × 150	12	50.8	64.7	9.5	9.5	2023	5.59	270	331	3272	391	0.569	19.7
150 × 150	12.5	52.7	67.1	9	9	2080	5.57	277	342	3375	402	0.568	19
160 × 160	5	24.1	30.7	29	29	1225	6.31	153	178	1892	226	0.627	41.5
160 × 160	6	28.7	36.6	23.7	23.7	1437	6.27	180	210	2233	264	0.625	34.8
160 × 160	6.3	30.1	38.3	22.4	22.4	1499	6.26	187	220	2333	275	0.624	33.3
160 × 160	8	37.6	48	17	17	1831	6.18	229	272	2880	335	0.619	26.6
160 × 160	10	46.3	58.9	13	13	2186	6.09	273	329	3478	398	0.614	21.6
160 × 160	12	54.6	69.5	10.3	10.3	2502	6	313	382	4028	454	0.609	18.3
160 × 160	12.5	56.6	72.1	9.8	9.8	2576	5.98	322	395	4158	467	0.608	17.7
160 × 160	16	70.2	89.4	7	7	3028	5.82	379	476	4988	546	0.599	14.2
180 × 180	5	27.3	34.7	33	33	1765	7.13	196	227	2718	290	0.707	36.7
180 × 180	6	32.5	41.4	27	27	2077	7.09	231	269	3215	340	0.705	30.8
180 × 180	6.3	34	43.3	25.6	25.6	2168	7.07	241	281	3361	355	0.704	29.4
180 × 180	8	42.7	54.4	19.5	19.5	2661	7	296	349	4162	434	0.699	23.4
180 × 180	10	52.5	66.9	15	15	3193	6.91	355	424	5048	518	0.694	19
180 × 180	12	62.1	79.1	12	12	3677	6.82	409	494	5873	595	0.689	16.1
180 × 180	12.5	64.4	82.1	11.4	11.4	3790	6.8	421	511	6070	613	0.688	15.5
180 × 180	16	80.2	102	8.25	8.25	4504	6.64	500	621	7343	724	0.679	12.5

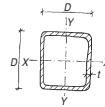

Hot finished square hollow sections – dimensions and properties – continued

SHS designation		Mass per metre kg/m	Area of section A cm ²	Ratios for local buckling		Second moment of area I cm ⁴	Radius of gyration r cm	Elastic modulus Z cm ³	Plastic modulus S cm ³	Torsional constants			Surface area of section m ² /m	Approx length per tonne m
Size D × B mm × mm	Thickness T mm			Flange b/t	Web d/t					J cm ⁴	C cm ³			
200 × 200	5	30.4	38.7	37	37	2445	7.95	245	283	3756	362	0.787	32.9	
200 × 200	6	36.2	46.2	30.3	30.3	2883	7.9	288	335	4449	426	0.785	27.6	
200 × 200	6.3	38	48.4	28.7	28.7	3011	7.89	301	350	4653	444	0.784	26.3	
200 × 200	8	47.7	60.8	22	22	3709	7.81	371	436	5778	545	0.779	21	
200 × 200	10	58.8	74.9	17	17	4471	7.72	447	531	7031	655	0.774	17	
200 × 200	12	69.6	88.7	13.7	13.7	5171	7.64	517	621	8208	754	0.769	14.4	
200 × 200	12.5	72.3	92.1	13	13	5336	7.61	534	643	8491	778	0.768	13.8	
200 × 200	16	90.3	115	9.5	9.5	6394	7.46	639	785	10340	927	0.759	11.1	
250 × 250	5	38.3	48.7	47	47	4861	9.99	389	447	7430	577	0.987	46.1	
250 × 250	6	45.7	58.2	38.7	38.7	5752	9.94	460	531	8825	681	0.985	21.9	
250 × 250	6.3	47.9	61	36.7	36.7	6014	9.93	481	556	9238	712	0.984	20.9	
250 × 250	8	60.3	76.8	28.3	28.3	7455	9.86	596	694	11530	880	0.979	16.6	
250 × 250	10	74.5	94.9	22	22	9055	9.77	724	851	14110	1065	0.974	13.4	
250 × 250	12	88.5	113	17.8	17.8	10560	9.68	844	1000	16570	1237	0.969	11.3	
250 × 250	12.5	91.9	117	17	17	10920	9.66	873	1037	17160	1279	0.968	10.9	
250 × 250	16	115	147	12.6	12.6	13270	9.5	1061	1280	21140	1546	0.959	8.67	
300 × 300	6	55.1	70.2	47	47	10080	12	672	772	15410	997	1.18	18.2	
300 × 300	6.3	57.8	73.6	44.6	44.6	10550	12	703	809	16140	1043	1.18	17.3	
300 × 300	8	72.8	92.8	34.5	34.5	13130	11.9	875	1013	20190	1294	1.18	13.7	
300 × 300	10	90.2	115	27	27	16030	11.8	1068	1246	24810	1575	1.17	11.1	
300 × 300	12	107	137	22	22	18780	11.7	1252	1470	29250	1840	1.17	9.32	
300 × 300	12.5	112	142	21	21	19440	11.7	1296	1525	30330	1904	1.17	8.97	
300 × 300	16	141	179	15.8	15.8	23850	11.5	1590	1895	37620	2325	1.16	7.12	
350 × 350	8	85.4	109	40.8	40.8	21130	13.9	1207	1392	32380	1789	1.38	11.7	
350 × 350	10	106	135	32	32	25880	13.9	1479	1715	39890	2185	1.37	9.44	
350 × 350	12	126	161	26.2	26.2	30430	13.8	1739	2030	47150	2563	1.37	7.93	
350 × 350	12.5	131	167	25	25	31540	13.7	1802	2107	48930	2654	1.37	7.62	
350 × 350	16	166	211	18.9	18.9	38940	13.6	2225	2607	60990	3264	1.36	6.04	
400 × 400	8	97.9	125	47	47	31860	16	1593	1830	48690	2363	1.58	10.2	
400 × 400	10	122	155	37	37	39130	15.9	1956	2260	60090	2895	1.57	8.22	
400 × 400	12	145	185	30.3	30.3	46130	15.8	2306	2679	71180	3405	1.57	6.9	
400 × 400	12.5	151	192	29	29	47840	15.8	2392	2782	73910	3530	1.57	6.63	
400 × 400	16	191	243	22	22	59340	15.6	2967	3484	92440	4362	1.56	5.24	

Source: Corus Construction (2002). Copyright Corus UK Ltd – reproduced with the kind permission of Corus UK Ltd.

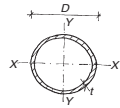

Hot finished circular hollow sections – dimensions and properties

CHS designation		Mass per metre	Area of section	Ratio for local buckling	Second moment of area	Radius of gyration	Elastic modulus	Plastic modulus	Torsional constants		Surface area of section	Approx length Per tonne
Outside diameter	Thickness								J	C		
D	t	kg/m	A	D/t	I	r	Z	S	J	C	m ² /m	m
mm	mm	kg/m	cm ²		cm ⁴	cm	cm ³	cm ³	cm ⁴	cm ³	m ² /m	m
21.3	3.2	1.43	1.82	6.7	0.768	0.65	0.722	1.06	1.54	1.44	0.067	700
26.9	3.2	1.87	2.38	8.4	1.7	0.846	1.27	1.81	3.41	2.53	0.085	535
33.7	3	2.27	2.89	11.2	3.44	1.09	2.04	2.84	6.88	4.08	0.106	440
33.7	3.2	2.41	3.07	10.5	3.6	1.08	2.14	2.99	7.21	4.28	0.106	415
33.7	3.6	2.67	3.4	9.4	3.91	1.07	2.32	3.28	7.82	4.64	0.106	374
33.7	4	2.93	3.73	8.4	4.19	1.06	2.49	3.55	8.38	4.97	0.106	341
42.4	3	2.91	3.71	14.1	7.25	1.4	3.42	4.67	14.5	6.84	0.133	343
42.4	3.2	3.09	3.94	13.3	7.62	1.39	3.59	4.93	15.2	7.19	0.133	323
42.4	3.6	3.44	4.39	11.8	8.33	1.38	3.93	5.44	16.7	7.86	0.133	290
42.4	4	3.79	4.83	10.6	8.99	1.36	4.24	5.92	18	8.48	0.133	264
48.3	2.5	2.82	3.6	19.3	9.46	1.62	3.92	5.25	18.9	7.83	0.152	354
48.3	3	3.35	4.27	16.1	11	1.61	4.55	6.17	22	9.11	0.152	298
48.3	3.2	3.56	4.53	15.1	11.6	1.6	4.8	6.52	23.2	9.59	0.152	281
48.3	3.6	3.97	5.06	13.4	12.7	1.59	5.26	7.21	25.4	10.5	0.152	252
48.3	4	4.37	5.57	12.1	13.8	1.57	5.7	7.87	27.5	11.4	0.152	229
48.3	5	5.34	6.8	9.7	16.2	1.54	6.69	9.42	32.3	13.4	0.152	187
60.3	2.5	3.56	4.54	24.1	19	2.05	6.3	8.36	38	12.6	0.189	281
60.3	3	4.24	5.4	20.1	22.2	2.03	7.37	9.86	44.4	14.7	0.189	236
60.3	3.2	4.51	5.74	18.8	23.5	2.02	7.78	10.4	46.9	15.6	0.189	222
60.3	3.6	5.03	6.41	16.8	25.9	2.01	8.58	11.6	51.7	17.2	0.189	199
60.3	4	5.55	7.07	15.1	28.2	2	9.34	12.7	56.3	18.7	0.189	180
60.3	5	6.82	8.69	12.1	33.5	1.96	11.1	15.3	67	22.2	0.189	147
76.1	2.52	4.54	5.78	30.4	39.2	2.6	10.3	13.5	78.4	20.6	0.239	220
76.1	3	5.41	6.89	25.4	46.1	2.59	12.1	16	92.2	24.2	0.239	185
76.1	3.2	5.75	7.33	23.8	48.8	2.58	12.8	17	97.6	25.6	0.239	174
76.1	3.6	6.44	8.2	21.1	54	2.57	14.2	18.9	108	28.4	0.239	155
76.1	4	7.11	9.06	19	59.1	2.55	15.5	20.8	118	31	0.239	141
76.1	5	8.77	11.2	15.2	70.9	2.52	18.6	25.3	142	37.3	0.239	114
76.1	6	10.4	13.2	12.7	81.8	2.49	21.5	29.6	164	43	0.239	96.4
76.1	6.3	10.8	13.8	12.1	84.8	2.48	22.3	30.8	170	44.6	0.239	92.2
88.9	2.5	5.33	6.79	35.6	63.4	3.06	14.3	18.7	127	28.5	0.279	188
88.9	3	6.36	8.1	29.6	74.8	3.04	16.8	22.1	150	33.6	0.279	157
88.9	3.2	6.76	8.62	27.8	79.2	3.03	17.8	23.5	158	35.6	0.279	148
88.9	3.6	7.57	9.65	24.7	87.9	3.02	19.8	26.2	176	39.5	0.279	132
88.9	4	8.38	10.7	22.2	96.3	3	21.7	28.9	193	43.3	0.279	119
88.9	5	10.3	13.2	17.8	116	2.97	26.2	35.2	233	52.4	0.279	96.7
88.9	6	12.3	15.6	14.8	135	2.94	30.4	41.3	270	60.7	0.279	81.5
88.9	6.3	12.8	16.3	14.1	140	2.93	31.5	43.1	280	63.1	0.279	77.9
114.3	3	8.23	10.5	38.1	163	3.94	28.4	37.2	325	56.9	0.359	121
114.3	3.2	8.77	11.2	35.7	172	3.93	30.2	39.5	345	60.4	0.359	114
114.3	3.6	9.83	12.5	31.8	192	3.92	33.6	44.1	384	67.2	0.359	102
114.3	4	10.9	13.9	28.6	211	3.9	36.9	48.7	422	73.9	0.359	91.9
114.3	5	13.5	17.2	22.9	257	3.87	45	59.8	514	89.9	0.359	74.2
114.3	6	16	20.4	19.1	300	3.83	52.5	70.4	600	105	0.359	62.4
114.3	6.3	16.8	21.4	18.1	313	3.82	54.7	73.6	625	109	0.359	59.6

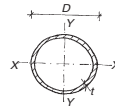

Hot finished circular hollow sections – dimensions and properties – continued

DHS designation		Mass per metre	Area of section	Ratio for local buckling	Second moment of area	Radius of gyration	Elastic modulus	Plastic modulus	Torsional constants		Surface area of section	Approx length per tonne
Outside diameter D	Thickness t								J	C		
mm	mm	kg/m	cm ²		cm ⁴	cm	cm ³	cm ³	cm ⁴	cm ³	m ² /m	m
139.7	3.2	10.8	13.7	43.7	320	4.83	45.8	59.6	640	91.6	0.439	92.8
139.7	3.6	12.1	15.4	38.8	357	4.81	51.1	66.7	713	102	0.439	82.8
139.7	4	13.4	17.1	34.9	393	4.8	56.2	73.7	786	112	0.439	74.7
139.7	5	16.6	21.2	27.9	481	4.77	68.8	90.8	961	138	0.439	60.2
139.7	6	19.8	25.2	23.3	564	4.73	80.8	107	1129	162	0.439	50.5
139.7	6.3	20.7	26.4	22.2	589	4.72	84.3	112	1177	169	0.439	48.2
139.7	8	26	33.1	17.5	720	4.66	103	139	1441	206	0.439	38.5
139.7	10	32	40.7	14	862	4.6	123	169	1724	247	0.439	31.3
168.3	3.2	13	16.6	52.6	566	5.84	67.2	87.2	1131	134	0.529	76.8
168.3	3.6	14.6	18.6	46.8	632	5.82	75.1	97.7	1264	150	0.529	68.4
168.3	4	16.2	20.6	42.1	697	5.81	82.8	108	1394	166	0.529	61.7
168.3	5	20.1	25.7	33.7	856	5.78	102	133	1712	203	0.529	49.7
168.3	6	24	30.6	28.1	1009	5.74	120	158	2017	240	0.529	41.6
168.3	6.3	25.2	32.1	26.7	1053	5.73	125	165	2107	250	0.529	39.7
168.3	8	31.6	40.3	21	1297	5.67	154	206	2595	308	0.529	31.6
168.3	10	39	49.7	16.8	1564	5.61	186	251	3128	372	0.529	25.6
168.3	12	46.3	58.9	14	1810	5.54	215	294	3620	430	0.529	21.6
168.3	12.5	48	61.2	13.5	1868	5.53	222	304	3737	444	0.529	20.8
193.7	5	23.3	29.6	38.7	1320	6.67	136	178	2640	273	0.609	43
193.7	6	27.8	35.4	32.3	1560	6.64	161	211	3119	322	0.609	36
193.7	6.3	29.1	37.1	30.7	1630	6.63	168	221	3260	337	0.609	34.3
193.7	8	36.6	46.7	24.2	2016	6.57	208	276	4031	416	0.609	27.3
193.7	10	45.3	57.7	19.4	2442	6.5	252	338	4883	504	0.609	22.1
193.7	12	53.8	68.5	16.1	2839	6.44	293	397	5678	586	0.609	18.6
193.7	12.5	55.9	71.2	15.5	2934	6.42	303	411	5869	606	0.609	17.9
219.1	5	26.4	33.6	43.8	1928	7.57	176	229	3856	352	0.688	37.9
219.1	6	31.5	40.2	36.5	2282	7.54	208	273	4564	417	0.688	31.7
219.1	6.3	33.1	42.1	34.8	2386	7.53	218	285	4772	436	0.688	30.2
219.1	8	41.6	53.1	27.4	2960	7.47	270	357	5919	540	0.688	24
219.1	10	51.6	65.7	21.9	3598	7.4	328	438	7197	657	0.688	19.4
219.1	12	61.3	78.1	18.3	4200	7.33	383	515	8400	767	0.688	16.3
219.1	12.5	63.7	81.1	17.5	4345	7.32	397	534	8689	793	0.688	15.7
219.1	16	80.1	102	13.7	5297	7.2	483	661	10590	967	0.688	12.5
244.5	5	29.5	37.6	48.9	2699	8.47	221	287	5397	441	0.768	33.9
244.5	6	35.3	45	40.8	3199	8.43	262	341	6397	523	0.768	28.3
244.5	6.3	37	47.1	38.8	3346	8.42	274	358	6692	547	0.768	27
244.5	8	46.7	59.4	30.6	4160	8.37	340	448	8321	681	0.768	21.4
244.5	10	57.8	73.7	24.5	5073	8.3	415	550	10150	830	0.768	17.3
244.5	12	68.8	87.7	20.4	5938	8.23	486	649	11880	972	0.768	14.5
244.5	12.5	71.5	91.1	19.6	6147	8.21	503	673	12290	1006	0.768	14
244.5	16	90.2	115	15.3	7533	8.1	616	837	15070	1232	0.768	11.1

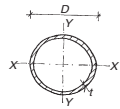

DHS designation		Mass per metre	Area of section	Ratio for local buckling	Second moment of area	Radius of gyration	Elastic modulus	Plastic modulus	Torsional constants		Surface area of section	Approx length per tonne
Outside diameter D	Thickness t		A	D/t	I	r	Z	S	J	C		
mm	mm	kg/m	cm ²		cm ⁴	cm	cm ³	cm ³	cm ⁴	cm ³	m ² /m	m
273	5	33	42.1	54.6	3781	9.48	277	359	7562	554	0.858	40.3
273	6	39.5	50.3	45.5	4487	9.44	329	428	8974	657	0.858	25.3
273	6.3	41.4	52.8	43.3	4696	9.43	344	448	9392	688	0.858	24.1
273	8	52.3	66.6	34.1	5852	9.37	429	562	11700	857	0.858	19.1
273	10	64.9	82.6	27.3	7154	9.31	524	692	14310	1048	0.858	15.4
273	12	77.2	98.4	22.8	8396	9.24	615	818	16790	1230	0.858	12.9
273	12.5	80.3	102	21.8	8697	9.22	637	849	17390	1274	0.858	12.5
273	16	101	129	17.1	10710	9.1	784	1058	21410	1569	0.858	9.86
323.9	5	39.3	50.1	64.8	6369	11.3	393	509	12740	787	1.02	25.4
323.9	6	47	59.9	54	7572	11.2	468	606	15140	935	1.02	21.3
323.9	6.3	49.3	62.9	51.4	7929	11.2	490	636	15860	979	1.02	20.3
323.9	8	62.3	79.4	40.5	9910	11.2	612	799	19820	1224	1.02	16
323.9	10	77.4	98.6	32.4	12160	11.1	751	986	24320	1501	1.02	12.9
323.9	12	92.3	118	27	14320	11	884	1168	28640	1768	1.02	10.8
323.9	12.5	96	122	25.9	14850	11	917	1213	29690	1833	1.02	10.4
323.9	16	121	155	20.2	18390	10.9	1136	1518	36780	2271	1.02	8.23
355.6	6.3	54.3	69.1	56.4	10550	12.4	593	769	21090	1186	1.12	18.4
355.6	8	68.6	87.4	44.5	13200	12.3	742	967	26400	1485	1.12	14.6
355.6	10	85.2	109	35.6	16220	12.2	912	1195	32450	1825	1.12	11.7
355.6	12	102	130	29.6	19140	12.2	1076	1417	38280	2153	1.12	9.83
355.6	12.5	106	135	28.4	19850	12.1	1117	1472	39700	2233	1.12	9.45
355.6	16	134	171	22.2	24660	12	1387	1847	49330	2774	1.12	7.46
406.4	6.3	62.2	79.2	64.5	15850	14.1	780	1009	31700	1560	1.28	16.1
406.4	8	78.6	100	50.8	19870	14.1	978	1270	39750	1956	1.28	12.7
406.4	10	97.8	125	40.6	24480	14	1205	1572	48950	2409	1.28	10.2
406.4	12	117	149	33.9	28940	14	1424	1867	57870	2848	1.28	8.57
406.4	12.5	121	155	32.5	30030	13.9	1478	1940	60060	2956	1.28	8.24
406.4	16	154	196	25.4	37450	13.8	1843	2440	74900	3686	1.28	6.49
457	6.3	70	89.2	72.5	22650	15.9	991	1280	45310	1983	1.44	14.3
457	8	88.6	113	57.1	28450	15.9	1245	1613	56890	2490	1.44	11.3
457	10	110	140	45.7	35090	15.8	1536	1998	70180	3071	1.44	9.07
457	12	132	168	38.1	41560	15.7	1819	2377	83110	3637	1.44	7.59
457	12.5	137	175	36.6	43140	15.7	1888	2470	86290	3776	1.44	7.3
457	16	174	222	28.6	53960	15.6	2361	3113	107900	4723	1.44	5.75
508	6.3	77.9	99.3	80.6	31250	17.7	1230	1586	62490	2460	1.6	12.8
508	8	98.6	126	63.5	39280	17.7	1546	2000	78560	3093	1.6	10.1
508	10	123	156	50.8	48520	17.6	1910	2480	97040	3820	1.6	8.14
508	12	147	187	42.3	57540	17.5	2265	2953	115100	4530	1.6	6.81
508	12.5	153	195	40.6	59760	17.5	2353	3070	119500	4705	1.6	6.55
508	16	194	247	31.8	74910	17.4	2949	3874	149800	5898	1.6	5.15

Source: Corus Construction (2002). Copyright Corus UK Ltd – reproduced with the kind permission of Corus UK Ltd.

Mild steel rounds typically available

Bar diameter mm	Weight kg/m	Bar diameter mm	Weight kg/m	Bar diameter mm	Weight kg/m	Bar diameter mm	Weight kg/m
6	0.22	16	1.58	40	9.86	65	26.0
8	0.39	20	2.47	45	12.5	75	34.7
10	0.62	25	3.85	50	15.4	90	49.9
12	0.89	32	6.31	60	22.2	100	61.6

Mild steel square bars typically available

Bar size mm	Weight kg/m	Bar size mm	Weight kg/m	Bar size mm	Weight kg/m
8	0.50	25	4.91	50	19.60
10	0.79	30	7.07	60	28.30
12.5	1.22	32	8.04	75	44.20
16	2.01	40	12.60	90	63.60
20	3.14	45	15.90	100	78.50

Mild steel flats typically available

Bar size mm	Weight kg/m	Bar size mm	Weight kg/m	Bar size mm	Weight kg/m	Bar size mm	Weight kg/m	Bar size mm	Weight kg/m
13 × 3	0.307	45 × 6	2.120	65 × 40	20.40	100 × 15	11.80	160 × 10	12.60
13 × 6	0.611	45 × 8	2.830	70 × 8	4.40	100 × 20	15.70	160 × 12	15.10
16 × 3	0.378	45 × 10	3.530	70 × 10	5.50	100 × 25	19.60	160 × 15	18.80
20 × 3	0.466	45 × 12	4.240	70 × 12	6.59	100 × 30	23.60	160 × 20	25.20
20 × 5	0.785	45 × 15	5.295	70 × 20	11.0	100 × 40	31.40	180 × 6	8.50
20 × 6	0.940	45 × 20	7.070	70 × 25	13.70	100 × 50	39.30	180 × 10	14.14
20 × 10	1.570	45 × 25	8.830	75 × 6	3.54	110 × 6	5.18	180 × 12	17.00
25 × 3	0.589	50 × 3	1.180	75 × 8	4.71	110 × 10	8.64	180 × 15	21.20
25 × 5	0.981	50 × 5	1.960	75 × 10	5.90	110 × 12	10.40	180 × 20	28.30
25 × 6	1.18	50 × 6	2.360	75 × 12	7.07	110 × 20	17.30	180 × 25	35.30
25 × 8	1.570	50 × 8	3.140	75 × 15	8.84	110 × 50	43.20	200 × 6	9.90
25 × 10	1.960	50 × 10	3.93	75 × 20	11.78	120 × 6	5.65	200 × 10	15.70
25 × 12	2.360	50 × 12	4.71	75 × 25	14.72	120 × 10	9.42	200 × 12	18.80
30 × 3	0.707	50 × 15	5.89	75 × 30	17.68	120 × 12	11.30	200 × 15	23.60
30 × 5	1.180	50 × 20	7.85	80 × 6	3.77	120 × 15	14.10	200 × 20	31.40
30 × 6	1.410	50 × 25	9.81	80 × 8	5.02	120 × 20	18.80	200 × 25	39.20
30 × 8	1.880	50 × 30	11.80	80 × 10	6.28	120 × 25	23.60	200 × 30	47.20
30 × 10	2.360	50 × 40	15.70	80 × 12	7.54	130 × 6	6.10	220 × 10	17.25
30 × 12	2.830	55 × 10	4.56	80 × 15	9.42	130 × 8	8.16	220 × 15	25.87
30 × 20	4.710	60 × 8	3.77	80 × 20	12.60	130 × 10	10.20	220 × 20	34.50
35 × 6	1.650	60 × 10	4.71	80 × 25	15.70	130 × 12	12.20	220 × 25	43.20
35 × 10	2.750	60 × 12	5.65	80 × 30	18.80	130 × 15	15.30	250 × 10	19.60
35 × 12	3.300	60 × 15	7.07	80 × 40	25.10	130 × 20	20.40	250 × 12	23.60
35 × 20	5.500	60 × 20	9.42	80 × 50	31.40	130 × 25	25.50	250 × 15	29.40
40 × 3	0.942	60 × 25	11.80	90 × 6	4.24	140 × 6	6.60	250 × 20	39.20
40 × 5	1.570	60 × 30	14.14	90 × 10	7.07	140 × 10	11.00	250 × 25	49.10
40 × 6	1.880	65 × 5	2.55	90 × 12	8.48	140 × 12	13.20	250 × 40	78.40
40 × 8	2.510	65 × 6	3.06	90 × 15	10.60	140 × 20	22.00	250 × 50	98.10
40 × 10	3.140	65 × 8	4.05	90 × 20	14.10	150 × 6	7.06	280 × 12.5	27.48
40 × 12	3.770	65 × 10	5.10	90 × 25	17.70	150 × 8	9.42	300 × 10	23.55
40 × 15	4.710	65 × 12	6.12	100 × 5	3.93	150 × 10	11.80	300 × 12	28.30
40 × 20	6.280	65 × 15	7.65	100 × 6	4.71	150 × 12	14.10	300 × 15	35.30
40 × 25	7.850	65 × 20	10.20	100 × 8	6.28	150 × 15	17.70	300 × 20	47.10
40 × 30	9.420	65 × 25	12.80	100 × 10	7.85	150 × 20	23.60	300 × 25	58.80
45 × 3	1.060	65 × 30	15.30	100 × 12	9.42	150 × 25	29.40	300 × 40	94.20

Hot rolled mild steel plates typically available

Thick- ness mm	Weight kg/m ²	Thick- ness mm	Weight kg/m ²	Thick- ness mm	Weight kg/m ²	Thick- ness mm	Weight kg/m ²	Thick- ness mm	Weight kg/m ²
3	23.55	10	78.50	30	235.50	55	431.75	90	706.50
3.2	25.12	12.5	98.12	32	251.20	60	471.00	100	785.00
4	31.40	15	117.75	35	274.75	65	510.25	110	863.50
5	39.25	20	157.00	40	314.00	70	549.50	120	942.00
6	47.10	22.5	176.62	45	353.25	75	588.75	130	1050.50
8	62.80	25	196.25	50	392.50	80	628.00	150	1177.50

Durbar mild steel floor plates typically available

Basic size mm	Weight kg/m ²	Basic size mm	Weight kg/m ²
2500 × 1250 × 3 3000 × 1500 × 3	26.19	3000 × 1500 × 8 3700 × 1830 × 8 4000 × 1750 × 8 6100 × 1830 × 8	65.44
2000 × 1000 × 4.5 2500 × 1250 × 4.5 3000 × 1250 × 4.5 3700 × 1830 × 4.5 4000 × 1750 × 4.5	37.97	2000 × 1000 × 10 2500 × 1250 × 10 3000 × 1500 × 10 3700 × 1830 × 10	81.14
2000 × 1000 × 6 2500 × 1250 × 6 3000 × 1500 × 6 3700 × 1830 × 6 4000 × 1750 × 6	49.74	2000 × 1000 × 12.5 2500 × 1250 × 12.5 3000 × 1500 × 12.5 3700 × 1830 × 12.5 4000 × 1750 × 12.5	100.77
2000 × 1000 × 8 2500 × 1250 × 8	65.44	The depth of pattern ranges from 1.9 to 2.4 mm.	

Slenderness

Slenderness and elastic buckling

The slenderness (λ) of a structural element indicates how much load the element can carry in compression. Short stocky elements have low values of slenderness and are likely to fail by crushing, while elements with high slenderness values will fail by elastic (reversible) buckling. Slender columns will buckle when the axial compression reaches the critical load. Slender beams will buckle when the compressive stress causes the compression flange to buckle and twist sideways. This is called Lateral Torsional Buckling and it can be avoided (and the load capacity of the beam increased) by restraining the compression flange at intervals or over its full length. Full lateral restraint can be assumed if the construction fixed to the compression flange is capable of resisting a force of not less than 2.5% of the maximum force in that flange distributed uniformly along its length.

Slenderness limits







Slenderness, $\lambda = L_e/r$ where L_e is the effective length and r is the radius of gyration – generally about the weaker axis.

For robustness, members should be selected so that their slenderness does not exceed the following limits:

Members resisting load other than wind	$\lambda \leq 180$
Members resisting self-weight and wind only	$\lambda \leq 250$
Members normally acting as ties but subject to load reversal due to wind	$\lambda \leq 350$

Effective length for different restraint conditions

Effective length of beams – end restraint

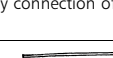



Conditions of restraint at the ends of the beams		Effective length		
		Normal loading	Destabilizing loading	
Compression flange laterally restrained; beam fully restrained against torsion (rotation about the longitudinal axis)	Both flanges fully restrained against rotation on plan		0.70L	0.85L
	Compression flange fully restrained against rotation on plan		0.75L	0.90L
	Both flanges partially restrained against rotation on plan		0.80L	0.95L
	Compression flange partially restrained against rotation on plan		0.85L	1.00L
	Both flanges free to rotate on plan		1.00L	1.20L
Compression flange laterally unrestrained; both flanges free to rotate on plan	Partial torsional restraint against rotation about the longitudinal axis provided by connection of bottom flange to supports		$1.0L + 2D$	$1.2L + 2D$
	Partial torsional restraint against rotation about the longitudinal axis provided only by the pressure of the bottom flange bearing onto the supports		$1.2L + 2D$	$1.4L + 2D$

NOTE:





The illustrated connections are not the only methods of providing the restraints noted in the table.

Source: BS 5950: Part 1: 2000.

Effective length of cantilevers

Conditions of restraint		Effective length	
Support	Cantilever tip	Normal loading	Destabilizing loading
Continuous with lateral restraint to top flange 	Free	3.0L	7.5L
	Top flange laterally restrained	2.7L	7.5L
	Torsional restraint	2.4L	4.5L
	Lateral and torsional restraint	2.1L	3.6L
Continuous with partial torsional restraint 	Free	2.0L	5.0L
	Top flange laterally restrained	1.8L	5.0L
	Torsional restraint	1.6L	3.0L
	Lateral and torsional restraint	1.4L	2.4L
Continuous with lateral and torsional restraint 	Free	1.0L	2.5L
	Top flange laterally restrained	0.9L	2.5L
	Torsional restraint	0.8L	1.5L
	Lateral and torsional restraint	0.7L	1.2L
Restrained laterally, torsionally and against rotation on plan 	Free	0.8L	1.4L
	Top flange laterally restrained	0.7L	1.4L
	Torsional restraint	0.6L	0.6L
	Lateral and torsional restraint	0.5L	0.5L

Cantilever tip restraint conditions

Free	Top flange laterally restrained	Torsional Restraint	Lateral and torsional restraint
			

Source: BS 5950: Part 1: 2000.

Effective length of braced columns – restraint provided by cross bracing or shear wall

Conditions of restraint at the ends of the columns		Effective length
Effectively held in position at both ends	Effectively restrained in direction at both ends	0.70L
	Partially restrained in direction at both ends	0.85L
	Restrained in direction at one end	0.85L
	Not restrained in direction at either end	1.00L

Effective length of unbraced columns – restraint provided by sway of columns

Conditions of restraint at the ends of the columns		Effective length
Effectively held in position and restrained in direction at one end	Other end effectively restrained in direction	1.20L
	Other end partially restrained in direction	1.50L
	Other end not restrained in direction	2.00L

Source: BS 5950: Part 1: 2000.

Durability and fire resistance

Corrosion mechanism and protection

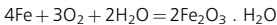

Iron/Steel + Oxygen + Water = Rust

For corrosion of steel to take place, oxygen and water must both be present. The corrosion rate is affected by the atmospheric pollution and the length of time the steelwork remains wet. Sulphates (typically from industrial pollution) and chlorides (typically in marine environments – coastal is considered to be a 2 km strip around the coast in the UK) can accelerate the corrosion rate. All corrosion occurs at the anode (–ve where electrons are lost) and the products of corrosion are deposited at the cathode (+ve where the electrons are gained). Both anodic and cathodic areas can be present on a steel surface.

The following factors should be considered in relation to the durability of a structure: the environment, degree of exposure, shape of the members, structural detailing, protective measures and whether inspection and maintenance are possible. Bi-metallic corrosion should also be considered in damp conditions.

Durability exposure conditions

Corrosive environments are classified by BS EN ISO 12944: Part 2 and ISO 9223, and the corrosivity of the environment must be assessed for each project.

Corrosivity category and risk	Examples of typical environments in a temperate climate*	
	Exterior	Interior
C1 – Very low	–	Heated buildings with clean atmospheres, e.g. offices, shops, schools, hotels, etc. (theoretically no protection is needed)
C2 – Low	Atmospheres with low levels of pollution. Mostly rural areas	Unheated buildings where condensation may occur, e.g. depots and sports halls
C3 – Medium	Urban and industrial atmospheres with moderate sulphur dioxide pollution. Coastal areas with low salinity	Production rooms with high humidity and some air pollution, e.g. food processing plants, laundries, breweries, dairies, etc.
C4 – High	Industrial areas and coastal areas with moderate salinity	Chemical plants, swimming pools, coastal ship and boatyards
C5I – Very high (industrial)	Industrial areas with high humidity and aggressive atmosphere	Buildings or areas with almost permanent condensation and high pollution
C5M – Very high (marine)	Coastal and offshore areas with high salinity	Buildings or areas with almost permanent condensation and high pollution

*A hot and humid climate increases the corrosion rate and steel will require additional protection than in a temperate climate.

BS EN ISO 12944: Part 3 gives advice on steelwork detailing to avoid crevices where moisture and dirt can be caught and accelerate corrosion. Some acidic timbers should be isolated from steelwork.

Get advice for each project: Corus can give advice on all steelwork coatings. The Galvanizers' Association, Metal Sprayers Association and paint manufacturers also give advice on system specifications.

Methods of corrosion protection

A corrosion protection system should consist of good surface preparation and application of a suitable coating with the required durability and minimum cost.

Mild steel surface preparation to BS EN ISO 8501

Hot rolled structural steelwork (in mild steel) leaves the last rolling process at about 1000°C. As it cools, its surface reacts with the air to form a blue-grey coating called mill scale, which is unstable, will allow rusting of the steel and will cause problems with the adhesion of protective coatings. The steel must be degreased to ensure that any contaminants which might affect the coatings are removed. The mill scale can then be removed by abrasive blast cleaning. Typical blast cleaning surface grades are:

Sa 1	Light blast cleaning
Sa 2	Thorough blast cleaning
Sa 2^{1/2}	Very thorough blast cleaning
Sa 3	Blast cleaning to visually clean steel

Sa 2^{1/2} is used for most structural steel. Sa 3 is often used for surface preparation for metal spray coatings.

Metallic and non-metallic particles can be used to blast clean the steel surface. Chilled angular metallic grit (usually grade G24) provides a rougher surface than round metallic shot, so that the coatings have better adhesion to the steel surface. Acid pickling is often used after blast cleaning to Sa 2^{1/2} to remove final traces of mill scale before galvanizing. Coatings must be applied very quickly after the surface preparation to avoid rust reforming and the requirement for reblasting.

Paint coatings for structural steel

Paint provides a barrier coating to prevent corrosion and is made up of pigment (for colour and protection), binder (for formation of the coating film) and solvent (to allow application of the paint before it evaporates and the paint hardens). When first applied, the paint forms a wet film thickness which can be measured and the dry film thickness (DFT – which is normally the specified element) can be predicted when the percentage volume of solids in the paint is known. Primers are normally classified on their protective pigment (e.g. zinc phosphate primer). Intermediate (which build the coating thickness) and finish coats are usually classified on their binders (e.g. epoxies, vinyls, urethanes, etc.). Shop primers (with a DFT of 15–25 µm) can be applied before fabrication but these only provide a couple of weeks' worth of protection. Zinc rich primers generally perform best. Application of paint can be by brush, roller, air spray and airless spray – the latter is the most common in the UK. Application can be done on site or in the shop and where the steel is to be exposed, the method of application should be chosen for practicality and the surface finish. Shop applied coatings tend to need touching up on site if they are damaged in transit.

Metallic coatings for structural steel

Hot dip galvanizing De-greased, blast cleaned (generally Sa 2^{1/2}) and then acid pickled steel is dipped into a flux agent and then into a bath of molten zinc. The zinc reacts with the surface of the steel, forming alloys and as the steel is lifted out a layer of pure zinc is deposited on outer surface of the alloys. The zinc coating is chemically bonded to the steel and is sacrificial. The Galvanizers' Association can provide details of galvanizing baths around the country, but the average bath size is about 10 m long × 1.2 m wide × 2 m deep. The largest baths available in 2002 in the UK are 21 m × 1.5 m × 2.4 m and 7.6 m × 2.1 m × 3 m. The heat can cause distortions in fabricated, asymmetric or welded elements. Galvanizing is typically 85–140 μm thick and should be carried out to BS EN ISO 1461 and 14713. Paint coatings can be applied on top of the galvanizing for aesthetic or durability reasons and an etch primer is normally required to ensure that the paint properly adheres to the galvanizing.

Thermal spray Degreased and blast cleaned (generally Sa 3) steel is sprayed with molten particles of aluminium or zinc. The coating is particulate and the pores normally need to be sealed with an organic sealant in order to prevent rust staining. Metal sprayed coatings are mechanically bonded to the steel and work partly by anodic protection and partly by barrier protection. There are no limits on the size of elements which can be coated and there are no distortion problems. Thermal spray is typically 150–200 μm thick in aluminium, 100–150 μm thick in zinc and should be carried out to BS EN 22063 and BS EN ISO 14713. Paint coatings can be applied for aesthetic or durability reasons. Bi-metallic corrosion issues should be considered when selecting fixings for aluminium sprayed elements in damp or external environments.

Weathering steel

Weathering steels are high strength, low alloy, weldable structural steels which form a protective rust coating in air that reaches a critical level within 2–5 years and prevents further corrosion. Cor-ten is the Corus proprietary brand of weathering steel, which has material properties comparable to S355, but the relevant material standard is BS EN 10 155. To optimize the use of weathering steel, avoid contact with absorbent surfaces (e.g. concrete), prolonged wetting (e.g. north faces of buildings in the UK), burial in soils, contact with dissimilar metals and exposure to aggressive environments. Even if these conditions are met, rust staining can still affect adjacent materials during the first few years. Weathering bolts (ASTM A325, Type 3 or Cor-ten X) must be used for bolted connections. Standard black bolts should not be used as the zinc coating will be quickly consumed and the fastener corroded. Normal welding techniques can be used.

Stainless steel

Stainless steel is the most corrosion resistant of all the steels due to the presence of chromium in its alloys. The surface of the steel forms a self-healing invisible oxide layer which prevents ongoing corrosion and so the surface must be kept clean and exposed to provide the oxygen required to maintain the corrosion resistance. Stainless steel is resistant to most things, but special precautions should be taken in chlorinated environments. Alloying elements are added in different percentages to alter the durability properties:

SS 304	18% Cr, 10% Ni	Used for general cladding, brick support angles, etc.
SS 409	11% Cr	Sometimes used for lintels
SS 316	17% Cr, 12% Ni, 2.5% Mo	Used in medium marine/aggressive environments
SS Duplex 2205	22% Cr, 5.5% Ni, 3% Mo	Used in extreme marine and industrial environments

Summary of methods of fire protection

System	Typical thickness ² for 60 mins protection	Advantages	Disadvantages
Boards Up to 4 hours' protection. Most popular system in the UK	25–30 mm	Clean 'boxed in' appearance; dry application; factory quality boards; needs no steel surface preparation	High cost; complex fitting around details; slow to apply
Vermiculite concrete spray Up to 4 hours' protection. Second most popular system in the UK	20 mm	Cheap; easy on complex junctions; needs no steel surface preparation; often boards used on columns, with spray on the beams	Poor appearance; messy application needs screening; the wet trade will affect following trades; compatibility with corrosion protection needs to be checked
Intumescent paint Maximum 2 hours' protection. Charring starts at 200–250°C	1–4 mm ¹	Good aesthetic; shows off form of steel; easy to cover complex details; can be applied in shop or on site	High cost; not suited to all environments; short periods of resistance; soft, thick, easily damaged coatings; difficult to get a really high quality finish; compatibility with corrosion protection needs to be checked
Flexible blanket Cheap alternative to sprays	20–30 mm	Low cost; dry fixing	Not good aesthetics
Concrete encasement Generally only used when durability is a requirement	25–50 mm	Provides resistance to abrasion, impact, corrosion and weather exposure	Expensive; time consuming; heavy; large thickness required
Concrete filled columns Used for up to 2 hours-protection or to reduce intumescent paint thickness on hollow sections	–	Takes up less plan area; acts as permanent shutter; good durability	No data for CHS posts; minimum section size which can be protected 140 × 140SHS; expensive
Water filled columns Columns interconnected to allow convection cooling. Only used if no other option	–	Long periods of fire resistance	Expensive; lots of maintenance required to control water purity and chemical content
Block filled column webs Up to 30 minutes protection	–	Reduced cost; less plan area; good durability	Limited protection times; not advised for steel in partition walls

NOTES:

1. Coating thickness specified on the basis of the sections' dimensions and the number of sides that will be exposed to fire.
2. Castellated beams need about 20% more fire protection than is calculated for the basic parent material.

Preliminary sizing of steel elements

Typical span/depth ratios

Element	Typical span (L) m	Beam depth
Primary beams/trusses (heavy point loads)	4–12	L/10–15
Secondary beams/trusses (distributed loads)	4–20	L/15–25
Transfer beams/trusses carrying floors	6–30	L/10
Castellated beams	4–12	L/10–15
Plate girders	10–30	L/10–12
Vierendeel girders	6–18	L/8–10
Parallel chord roof trusses	10–100	L/12–20
Pitched roof trusses	8–20	L/5–10
Light roof beams	6–60	L/18–30
Conventional lattice roof girders	5–20	L/12–15
Space frames (allow for 1/250 pre-camber)	10–100	L/15–30
Hot rolled universal column	single storey 2–8 multi-storey 2–4	L/20–25 L/7–18
Hollow section column	single storey 2–8 multi-storey 2–4	L/20–35 L/7–28
Lattice column	4–10	L/20–25
Portal leg and rafter (haunch depth <0.11)	9–60	L/35–40

Preliminary sizing

Beams

There are no shortcuts. Deflection will tend to govern long spans, while shear will govern short spans with heavy loading. Plate girders or trusses are used when the loading is beyond the capacity of rolled sections.

Columns – typical maximum column section size for braced frames

203 UC Buildings 2 to 3 storeys high and spans up to 7 m.

254 UC Buildings up to 5 storeys high.

305 UC Buildings up to 8 storeys high or supports for low rise buildings with long spans.

354 UC Buildings from 8 to 12 storeys high.

Columns – enhanced loads for preliminary axial design

An enhanced axial load for columns subject to out of balance loads can be used for preliminary design:

Top storey: Total axial load + 4Y – Y + 2X – X

Intermediate Total axial load + 2Y – Y + X – X

storey:

Where X–X and Y–Y are the net axial load differences in each direction.

Trusses with parallel chord

Axial force in chord, $F = M_{\text{applied}}/d$ where d is the distance between the chord centroids.

$I_{\text{truss}} = \sum (A_c d^2/4)$ where A_c is the area of each chord.

For equal chords this can be simplified to $I_{\text{truss}} = A_c d^2/2$.

Portal frames

The *Institution of Structural Engineers' Grey Book* for steel design gives the following preliminary method for sizing plastic portal frames with the following assumptions:

- Plastic hinges are formed at the eaves (in the stanchion) and near the apex, therefore Class 1 sections as defined in BS 5950 should be used.
- Moment at the end of the haunch is $0.87M_p$.
- Wind loading does not control the design.
- Stability of the frame should be checked separately.
- Load, W = vertical rafter load per metre run.

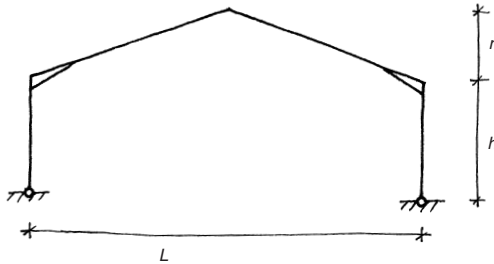

Horizontal base reaction, $H = H_{FR}WL$

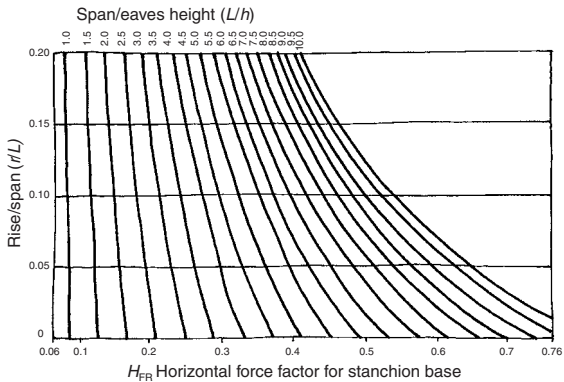

Design moment for rafter, $M_{p \text{ rafter}} = M_{pR}WL^2$

Also consider the high axial force which will be in the rafter and design for combined axial and bending!

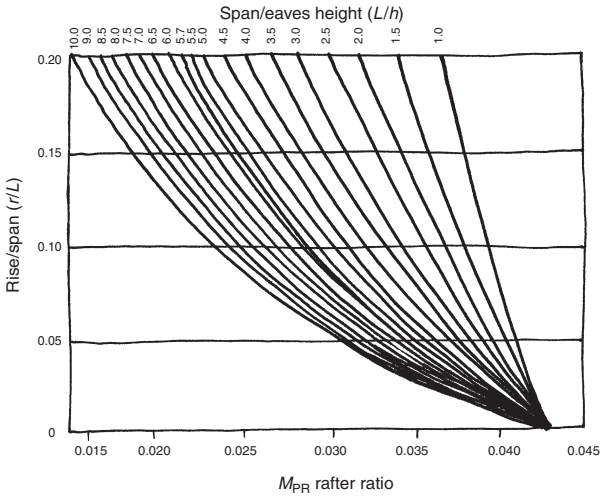

Design moment for stanchion, $M_p \text{ stanchion} = M_{PL}WL^2$

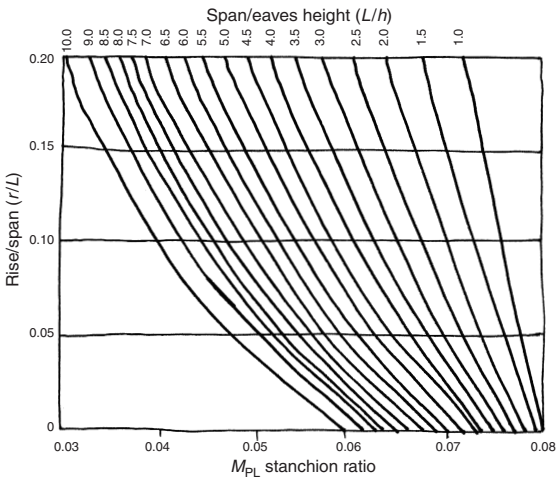

Source: IStructE (2002).

Steel design to BS 5950

BS 5950: Part 1 was written to allow designers to reduce conservatism in steel design. The resulting choice and complication of the available design methods has meant that sections are mainly designed using software or the SCI *Blue Book*. As the code is very detailed, the information about BS 5950 has been significantly summarized – covering only grade S275 steelwork and using the code's conservative design methods.

Partial safety factors

Load combination	Load type				
	Dead	Imposed	Wind	Crane loads	Earth and water pressures
Dead and imposed	1.4 or 1.0	1.6	–	–	1.4
Dead and wind	1.4 or 1.0	–	1.4	–	–
Dead and wind and imposed	1.2	1.2	1.2	–	–
Dead and crane loads	1.4	–	–	$V = 1.6$ $H = 1.6$	–
Dead and imposed and crane loads	1.2	Crane $V = 1.4$ Crane $H = 1.2$	–	V and $H = 1.4$ $V = 1.4$ $H = 1.2$ V and $H = 1.4$	–
Dead and wind and crane loads	1.2	–	1.2	1.2	–
Forces due to temperature change	–	1.2	–	–	–
Exceptional snow load due to drifting	–	1.05	–	–	–

Source: BS 5950: Part 1: 2000.

Selected mild steel design strengths

Steel grade	Steel thickness less than or equal to mm	Design strength, p_y N/mm ²
S275	16	275
	40	265
	63	255
S355	16	355
	40	345
	63	335

Generally it is more economic to use S275 where it is required in small quantities (less than 40 tonnes), where deflection instead of strength limits design, or for members such as nominal ties where the extra strength is not required. In other cases it is more economical to consider S355.

Ductility and steel grading

In addition to the strength of the material, steel must be specified for a suitable ductility to avoid brittle fracture, which is controlled by the minimum service temperature, the thickness of steel, the steel grade, the type of detail and the stress and strain levels. Ductility is measured by the Charpy V notch test. In the UK the minimum service temperature expected to occur over the design life of the structure should be taken as -5°C for internal steelwork or -15°C for external steelwork. For steelwork in cold stores or cold climates appropriate lower temperatures should be selected. Tables 4, 5, 6 and 7 in BS 5950 give the detailed method for selection of the appropriate steel grade. Steel grading has become more important now that the UK construction industry is using more imported steel. The latest British Standard has revised the notation used to describe the grades of steel. The equivalent grades are set out below:

Current grading references BS 5950: Part 1: 2000 and BS EN 100 25: 1993				Superseded grading references* BS 5950: Part 1: 1990 and BS 4360: 1990				
Grade	Charpy test temperature $^{\circ}\text{C}$	Steel use	Max steel thickness mm	Grade	Charpy test temperature $^{\circ}\text{C}$	Steel use	Max steel thickness mm	
							<100 N/mm ²	>100 N/mm ²
S275	Untested	Internal only	25	43 A	Untested	Internal	50	25
							External	30
S275 JR	Room temp. 20°C	Internal only	30	43 B	Room temp. 20°C	Internal	50	25
							External	30
S275 J0	0°C	Internal External	65 54	43 C	0°C	Internal External	n/a 80	60 40
			External				78	n/a
S275 J2	-20°C	Internal External	94 78	43 D	-20°C	Internal External	n/a n/a	n/a 90

* Where the superseded equivalent for grades S355 and S460 are Grades 50 and 55 respectively.

Source: BS 5950: Part 1: 2000.

Section classification and local buckling

Sections are classified by BS 5950 depending on how their cross section behaves under compressive load. Structural sections in thinner plate will tend to buckle locally and this reduces the overall compressive strength of the section and means that the section cannot achieve its full plastic moment capacity. Sections with tall webs tend to be slender under axial compression, while cross sections with wide out-stand flanges tend to be slender in bending. Combined bending and compression can change the classification of a cross section to slender, when that cross section might not be slender under either bending or compression when applied independently.

For plastic design, the designer must therefore establish the classification of a section (for the given loading conditions) in order to select the appropriate design method from those available in BS 5950. For calculations without capacity tables or computer packages, this can mean many design iterations.

BS 5950 has four types of section classification:

Class 1: Plastic	Cross sections with plastic hinge rotation capacity.
Class 2: Compact	Cross sections with plastic moment capacity.
Class 3: Semi-compact	Cross sections in which the stress at the extreme compression fibre can reach the design strength, but the plastic moment capacity cannot be developed.
Class 4: Slender	Cross sections in which it is necessary to make explicit allowance for the effects of local buckling.

Tables 11 and 12 in BS 5950 classify different hot rolled and fabricated sections based on the limiting width to thickness ratios for each section class. None of the UB, UC, RSJ or PFC sections are slender in pure bending. Under pure axial compression, none of the UC, RSJ or PFC sections are slender, but some UB and hollow sections can be:

UB	Slender if $d/t > 40\varepsilon$
SHS and RHS (hot rolled)	Slender if $d/t > 40\varepsilon$
CHS	Slender if $D/t > 80\varepsilon^2$

Where D = overall depth, t = plate thickness, d = web depth, p_y = design strength, $\varepsilon = \sqrt{275/p_y}$.

For simplicity only design methods for Class 1 and 2 sections are covered in this book.

Source: BS 5950: Part 1: 2000.

Tension members

Bolted connections: $P_t = (A_e - 0.5a_2) p_y$

Welded connections: $P_t = (A_e - 0.3a_2) p_y$

If $a_2 = A_g - a_1$ where A_g is the gross section area, A_e is the effective area (which is the net area multiplied by 1.2 for S275 steel, 1.1 for S355 or 1.0 for S460) and a_1 is the area of the connected part (web or flange, etc.).

Flexural members

Shear capacity, P_v

$$P_v = 0.6 p_y A_v$$

Where A_v is the shear area, which should be taken as:

tD	for rolled I sections (loaded parallel to the web) and rolled T sections
$AD/(D+B)$	for rectangular hollow sections
$t(D-T)$	for welded T sections
$0.6A$	for circular hollow sections
$0.9A$	solid bars and plates

t = web thickness, A = cross sectional area, D = overall depth, B = overall breadth, T = flange thickness.

If $d/t > 70$ for a rolled section, or >62 for a welded section, shear buckling must be allowed for (see BS 5950: clause 4.4.5).

Source: BS 5950: Part 1: 2000.

Moment capacity M_c

The basic moment capacity (M_c) depends on the provision of full lateral restraint and the interaction of shear and bending stresses. M_c is limited to $1.2p_y Z$ to avoid irreversible deformation under serviceability loads. Full lateral restraint can be assumed if the construction fixed to the compression flange is capable of resisting not less than 2.5% of the maximum compression force in the flange, distributed uniformly along the length of the flange. Moment capacity (M_c) is generally the controlling capacity for class 1 and 2 sections in the following cases:

- Bending about the minor axis.
- CHS, SHS or small solid circular or square bars.
- RHS in some cases given in clause 4.3.6.1 of BS 5950.
- UB, UC, RSJ, PFC, SHS or RHS if $\lambda < 34$ for S275 steel and $\lambda < 30$ for S355 steel in Class 1 and 2 sections, where $\lambda = L_E/r$.

Low shear ($F_v < 0.6P_v$) $M_c = p_y S$

High shear ($F_v > 0.6P_v$) $M_c = p_y (S - \rho S_v)$

Where $\rho = \left(2 \frac{F_v}{P_v} - 1\right)^2$ and S_v = the plastic modulus of the shear area used to calculate P_v .

Lateral torsional buckling capacity M_b

Lateral torsional buckling (LTB) occurs in tall sections or long beams in bending if not enough restraint is provided to the compression flange. Instability of the compression flange results in buckling of the beam, preventing the section from developing its full plastic capacity, M_c . The reduced bending moment capacity, M_b , depends on the slenderness of the section, λ_{LT} . For Class 1 and 2 sections, $\lambda_{LT} = \lambda$.

A simplified and conservative method of calculating M_b for rolled sections uses D/T and λ_{LT} to determine an ultimate bending stress p_b (from the following graph) where $M_b = p_b S_x$ for Class 1 and 2 sections.

Source: BS 5950: Part 1: 2000.

Compression members

The compression capacity of Class 1 and 2 sections can be calculated as $P_c = A_g p_c$, where A_g is the gross area of the section and p_c can be estimated depending on the expected buckling axis and the section type for steel of ≤ 40 mm thickness.

Type of section	Strut curve for value of p_c	
	Axis of buckling	
	x-x	y-y
Hot finished structural hollow section	a	a
Rolled I section	a	b
Rolled H section	b	c
Round, square or flat bar	b	b
Rolled angle, channel or T section/paired rolled sections/compound rolled sections	Any axis: c	

Ultimate compression stresses for rolled sections, p_c

Ultimate compression stresses for rolled sections, p_c

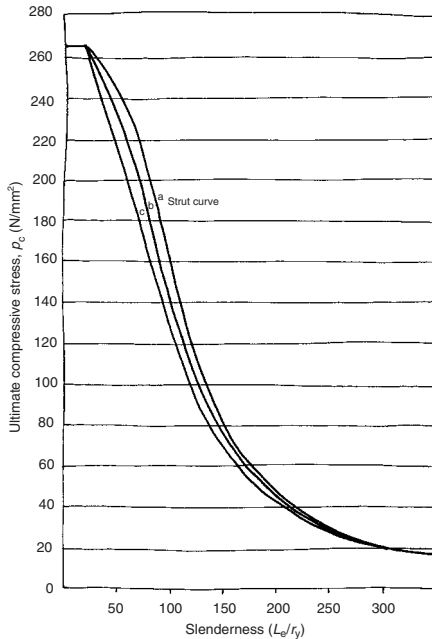

Combined bending and compression

Although each section should have its classification checked for combined bending and axial compression, the capacities from the previous tables can be checked against the following simplified relationship for section Classes 1 and 2:

$$\frac{F}{\bar{P}} + \frac{M_x}{M_{cx} \text{ or } M_b} + \frac{M_y}{M_{cy}} < 1.0$$

Section 4.8 in BS 5950 should be referred to in detail for all the relevant checks.

Connections

Welded connections

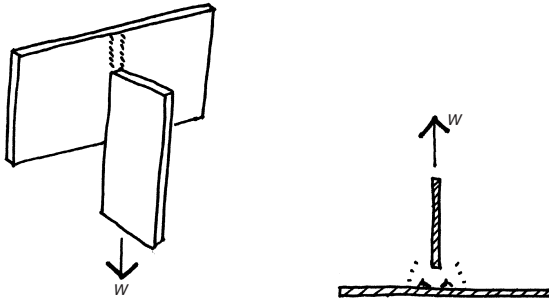

The resultant of combined longitudinal and transverse forces should be checked:

$$\left(\frac{F_L}{P_L}\right)^2 + \left(\frac{F_T}{P_T}\right)^2 < 1.0.$$

Ultimate fillet weld capacities for S275 elements joined at 90°

Leg length s mm	Throat thickness $a = 0.7s$ mm	Longitudinal capacity* $P_L = p_w$ kN/mm	Transverse capacity* $P_T = p_w a K$ kN/mm
4	2.8	0.616	0.770
6	4.2	0.924	1.155
8	5.6	1.232	1.540
12	8.4	1.848	2.310

* Based on values for S275, $p_w = 220 \text{ N/mm}^2$ and $K = 1.25$.

Bolted connections

Limiting bolt spacings

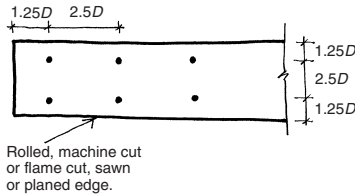

Direct shear

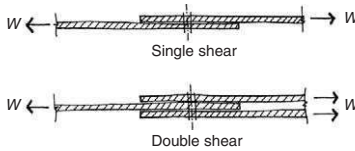

Simple moment connection bolt groups

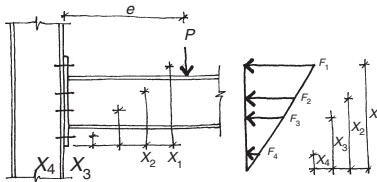

$$M_{cap} = \left(\frac{\text{no. rows of bolts}}{x_1} \right) P_t \sum x_i^2$$

$$V = \frac{P_t}{n}$$

$$F_n = P_t \frac{x_n}{x_{n-1}}$$

Where $x_1 = \max x_i$ and $x_i =$ depth from point of rotation to centre of bolt being considered, P_t is the tension capacity of the bolts, n is the number of bolts, V is the shear on each bolt and F is the tension in each bolt. This is a simplified analysis which assumes that the bolt furthest from the point of rotation carries the most load. As the connection elements are likely to be flexible, this is unlikely to be the case; however, more complicated analysis requires a computer or standard tables.

Bolt capacity checks For bolts in shear or tension see the following tabulated values. For bolts in shear and tension check: $(F_v/P_v) + (F_t/P_t) \leq 1.4$ where F indicates the factored design load and P indicates the ultimate bolt capacity.

Selected ultimate bolt capacities for non-pre-loaded ordinary bolts in S275 steel

Diameter of bolt, ϕ mm	Tensile stress area mm ²	Tension capacity kN	Shear capacity		Bearing capacity for end distance = 2ϕ kN						
			Single kN	Double kN	Thickness of steel passed through mm						
					5	6	8	10	12	15	20
Grade 4.6											
6	20.1	3.9	3.2	6.4	13.8	16.6	22.1	27.6	33.1	41.4	55.2
8	36.6	7.0	5.9	11.7	18.4	22.1	29.4	36.8	44.2	55.2	73.6
10	58	11.1	9.3	18.6	23.0	27.6	36.8	46.0	55.2	69.0	92.0
12	84.3	16.2	13.5	27.0	27.6	33.1	44.2	55.2	66.2	82.8	110.4
16	157	30.1	25.1	50.2	36.8	44.2	58.9	73.6	88.3	110.4	147.2
20	245	47.0	39.2	78.4	46.0	55.2	73.6	92.0	110.4	138.0	184.0
24	353	67.8	56.5	113.0	55.2	66.2	88.3	110.4	132.5	165.6	220.8
30	561	107.7	89.8	179.5	69.0	82.8	110.4	138.0	165.6	207.0	276.0
Grade 8.8											
6	20.1	9.0	7.5	15.1	13.8	6.6	22.1	27.6	33.1	41.4	55.2
8	36.6	16.4	13.7	27.5	18.4	22.1	29.4	36.8	44.2	55.2	73.6
10	58	26.0	21.8	43.5	23.0	27.6	36.8	46.0	55.2	69.0	92.0
12	84.3	37.8	31.6	63.2	27.6	33.1	44.2	55.2	66.2	82.8	110.4
16	157	70.3	58.9	117.8	36.8	44.2	58.9	73.6	88.3	110.4	147.2
20	245	109.8	91.9	183.8	46.0	55.2	73.6	92.0	110.4	138.0	184.0
24	353	158.1	132.4	264.8	55.2	66.2	88.3	110.4	132.5	165.6	220.8
30	561	251.3	210.4	420.8	69.0	82.8	110.4	138.0	165.6	207.0	276.0

NOTES:

- 2 mm clearance holes for $\phi < 24$ or 3 mm clearance holes for $\phi < 24$.
- Tabulated tension capacities are nominal tension capacity = $0.8A_t p_t$ which accounts for prying forces.
- Bearing values shown in **bold** are less than the single shear capacity of the bolt.
- Bearing values shown in *italic* are less than the double shear capacity of the bolt.
- Multiply tabulated bearing values by 0.7 if oversized or short slotted holes are used.
- Multiply tabulated bearing values by 0.5 if kidney shaped or long slotted holes are used.
- Shear capacity should be reduced for large packing, grip lengths or long joints.

Selected ultimate bolt capacities for non-pre-loaded countersunk bolts in S275 steel

Diameter of bolt, ϕ mm	Tensile stress area mm ²	Tension capacity kN	Shear capacity		Bearing capacity for end distance = 2ϕ kN						
			Single kN	Double kN	Thickness of steel passed through (mm)						
					5	6	8	10	12	15	20
Grade 4.6											
6	20.1	3.9	3.2	6.4	8.6	11.3	16.8	22.4	27.9	36.2	50.0
8	36.6	7.0	5.9	11.7	–	12.9	20.2	27.6	35.0	46.0	64.4
10	58	11.1	9.3	18.6	–	–	21.9	31.1	40.3	54.1	77.1
12	84.3	16.2	13.5	27.0	–	–	–	34.5	45.5	62.1	89.7
16	157	30.1	25.1	50.2	–	–	–	–	55.2	77.3	114.1
20	245	47.0	39.2	78.4	–	–	–	–	62.1	89.7	135.7
24	353	67.8	56.5	113.0	–	–	–	–	–	85.6	140.8
Grade 8.8											
6	20.1	9.0	7.5	15.1	8.6	11.3	16.8	22.4	27.9	36.2	50.0
8	36.6	16.4	13.7	27.5	–	12.9	20.2	27.6	35.0	46.0	64.4
10	58	26.0	21.8	43.5	–	–	21.9	31.1	40.3	54.1	77.1
12	84.3	37.8	31.6	63.2	–	–	–	34.5	45.5	62.1	89.7
16	157	70.3	58.9	117.8	–	–	–	–	55.2	77.3	114.1
20	245	109.8	91.9	183.8	–	–	–	–	62.1	89.7	135.7
24	353	158.1	132.4	264.8	–	–	–	–	–	85.6	140.8

NOTES:

- Values are omitted from the table where the bolt head is too deep to be countersunk into the thickness of the plate.
- 2 mm clearance holes for $\phi < 24$ or 3 mm clearance holes for $\phi < 24$.
- Tabulated tension capacities are nominal tension capacity = $0.8A_p$, which accounts for prying forces.
- Bearing values shown in **bold** are less than the single shear capacity of the bolt.
- Bearing values shown in *italic* are less than the double shear capacity of the bolt.
- Multiply tabulated bearing values by 0.7 if oversized or short slotted holes are used.
- Multiply tabulated bearing values by 0.5 if kidney shaped or long slotted holes are used.
- Shear capacity should be reduced for large packing, grip lengths or long joints.

Steel design to BS 449

BS 449: Part 2 is the 'old' steel design code issued in 1969 but it is (with amendments) still current. The code is based on elastic bending and working stresses and is very simple to use. It is therefore invaluable for preliminary design, for simple steel elements and for checking existing structures. It is normal to compare the applied and allowable stresses. BS 449 refers to the old steel grades where Grade 43 is S275, Grade 50 is S355 and Grade 55 is S460.

Notation for BS 449: Part 2

Symbols		Stress subscripts	
f	Applied stress	c or bc	Compression or bending compression
P	Permissible stress	t or bt	Tension or bending tension
l/r	Slenderness ratio	q	Shear
D	Overall section depth	b	Bearing
t	Flange thickness	e	Equivalent

Allowable stresses

The allowable stresses may be exceeded by 25% where the member has to resist an increase in stress which is solely due to wind forces – provided that the stresses in the section before considering wind are within the basic allowable limits.

Applied stresses are calculated using the gross elastic properties of the section, Z or A , where appropriate.

Allowable stress in axial tension P_t

Form	Steel grade	Thickness of steel mm	P_t N/mm ²
Sections, bars, plates, wide flats and hollow sections	43 (S275)	$t \leq 40$	170
		$40 < t \leq 100$	155

Source: BS 449: Part 2: 1969.

Maximum allowable bending stresses P_{bc} or P_{bt}

Form	Steel grade	Thickness of steel mm	P_{bc} or P_{bt} N/mm ²
Sections, bars, plates, wide flats and hollow sections Compound beams – hot rolled sections with additional plates Double channel sections acting as an I beam	43 (S275)	$t \leq 40$	180
		$40 < t \leq 100$	165
Plate girders	43 (S275)	$t \leq 40$	170
		$40 < t \leq 100$	155
Slab bases	All steels		185

Upstand webs or flanges in compression have a reduced capacity and need to be checked in accordance with clause 20, BS 449. These tabulated values of P_{bc} can be used only where full lateral restraint is provided, where bending is about the minor axis or for hollow sections in bending.

Source: BS 449: Part 2: Table 2: 1969.

Allowable compressive stresses

For uncased compression members, allowable compressive stresses must be reduced by 10% for thick steel sections: if $t > 40$ mm for Grade 43 (S275), $t > 63$ mm for Grade 50 (S355) and $t > 25$ mm for Grade 55 (S460). The allowable axial stress, P_c , reduces as the slenderness of the element increases as shown in the following chart:

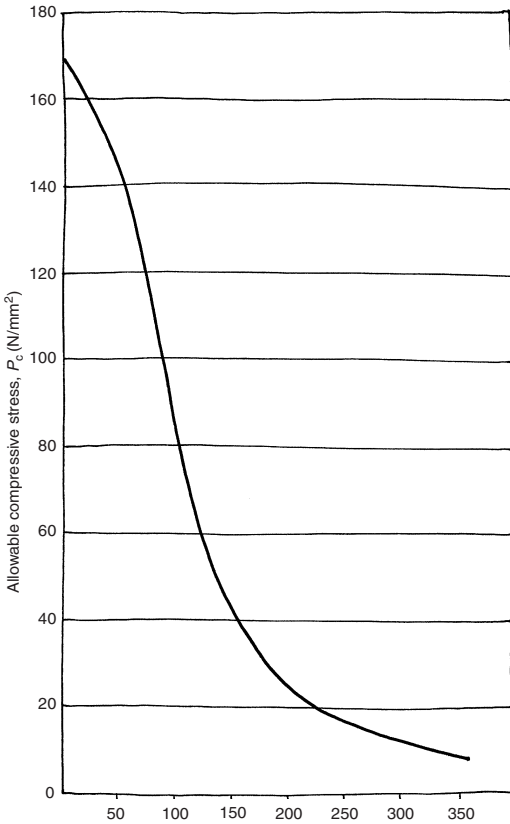

Allowable average shear stress P_v in unstiffened webs

Form	Steel grade	Thickness mm	P_v^* N/mm ²
Sections, bars, plates, wide flats and hollow sections	43 (S275)	$d \leq 40$	110
		$40 < d \leq 100$	100
	50 (S355)	$d \leq 63$	140
		$63 < d \leq 100$	130
55 (S460)	$d \leq 25$	170	

* See Table 12 in BS 449: Part 2 for allowable average shear stress in stiffened webs.

Section capacity checks

Combined bending and axial load

$$\text{Compression: } \frac{f_c}{P_c} + \frac{f_{bc_x}}{P_{bc_x}} + \frac{f_{bc_y}}{P_{bc_y}} \leq 1.0$$

$$\text{Tension: } \frac{f_t}{P_t} + \frac{f_{bt}}{P_{bt}} \leq 1.0 \quad \text{and} \quad \frac{f_{bc_x}}{P_{bc_x}} + \frac{f_{bc_y}}{P_{bc_y}} \leq 1.0$$

Combined bending and shear

$$f_e = \sqrt{(f_{bt}^2 + 3f_q^2)} \quad \text{or} \quad f_e = \sqrt{(f_{bc}^2 + 3f_q^2)} \quad \text{and} \quad f_e < P_e \quad \text{and} \quad (f_{bc}/P_o)^2 + (f'_q/P'_q)^2 \leq 1.25$$

Where f_e is the equivalent stress, f'_q is the average shear stress in the web, P_o is defined in BS 449 subclause 20 item 2b iii and P'_q is defined in clause 23. From BS 449: Table 1, the allowable equivalent stress $P_e = 250 \text{ N/mm}^2$ for Grade 43 (S275) steel $< 40 \text{ mm}$ thick.

Combined bending, shear and bearing

$$f_e = \sqrt{(f_{bt}^2 + f_b^2 + f_{bt}f_b + 3f_q^2)} \quad \text{or} \quad f_e = \sqrt{(f_{bc}^2 + f_b^2 + f_{bc}f_b + 3f_q^2)} \quad \text{and} \quad f_e < P_e \quad \text{and} \quad (f_{bc}/P_o)^2 + (f'_q/P'_q)^2 + (f_{cw}/P_{cw}) \leq 1.25$$

Source: BS 449: Part 2: 1969.

Connections

Selected fillet weld capacities for Grade 43 (S275) steel

Leg length s mm	Throat thickness $a = 0.7s$ mm	Weld capacity* kN/mm
4	2.8	0.32
6	4.2	0.48
8	5.6	0.64
12	8.4	0.97

*When a weld is subject to a combination of stresses, the combined effect should be checked using the same checks as used for combined loads on sections to BS 449.

Selected full penetration butt weld capacities for Grade 43 (S275) steel

Thickness mm	Shear capacity kN/mm	Tension or compression capacity* kN/mm
6	0.60	0.93
15	1.50	2.33
20	2.00	3.10
30	3.00	4.65

*When a weld is subject to a combination of stresses, the combined effect should be checked using the same checks as used for combined loads on sections to BS 449.

Source: BS 449: Part 2: 1969.

Allowable stresses in non-pre-loaded bolts

Description	Bolt grade	Axial tension N/mm ²	Shear N/mm ²	Bearing N/mm ²
Close tolerance and turned bolts	4.6	120	100	300
	8.8	280	230	350
Bolts in clearance holes	4.6	120	80	250
	8.8	280	187	350

Allowable stresses on connected parts of bolted connections (N/mm²)

Description	Allowable stresses on connected parts for different steel grades N/mm ²		
	43 (S275)	50 (S355)	55 (S460)
Close tolerance and turned bolts	300	420	480
Bolts in clearance holes	250	350	400

Source: BS 449: Part 2: 1969.

Selected working load bolt capacities for non-pre-loaded ordinary bolts in grade 43 (S275) steel

Diameter of bolt, ϕ mm	Tensile stress area mm ²	Tension capacity kN	Shear capacity		Bearing capacity for end distance = 2ϕ kN						
			Single kN	Double kN	Thickness of steel passed through						
					5	6	8	10	12	15	20
Grade 4.6											
6	20.1	1.9	1.6	3.2	7.5	9.0	12.0	15.0	18.0	22.5	30.0
8	36.6	3.5	2.9	5.9	10.0	12.0	16.0	20.0	24.0	30.0	40.0
10	58	5.6	4.6	9.3	12.5	15.0	20.0	25.0	30.0	37.5	50.0
12	84.3	8.1	6.7	13.5	15.0	18.0	24.0	30.0	36.0	45.0	60.0
16	157	15.1	12.6	25.1	20.0	24.0	32.0	40.0	48.0	60.0	80.0
20	245	23.5	19.6	39.2	25.0	30.0	40.0	50.0	60.0	75.0	100.0
24	353	33.9	28.2	56.5	30.0	36.0	48.0	60.0	72.0	90.0	120.0
30	561	53.9	44.9	89.8	37.5	45.0	60.0	75.0	90.0	112.5	150.0
Grade 8.8											
6	20.1	4.5	3.8	7.5	7.5	9.0	12.0	15.0	18.0	22.5	30.0
8	36.6	8.2	6.8	13.7	10.0	12.0	16.0	20.0	24.0	30.0	40.0
10	58	13.0	10.8	21.7	12.5	15.0	20.0	25.0	30.0	37.5	50.0
12	84.3	18.9	15.8	31.5	15.0	18.0	24.0	30.0	36.0	45.0	60.0
16	157	35.2	29.4	58.7	20.0	24.0	32.0	40.0	48.0	60.0	80.0
20	245	54.9	45.8	91.6	25.0	30.0	40.0	50.0	60.0	75.0	100.0
24	353	79.1	66.0	132.0	30.0	36.0	48.0	60.0	72.0	90.0	120.0
30	561	125.7	104.9	209.8	37.5	45.0	60.0	75.0	90.0	112.5	150.0

NOTES:

- 2 mm clearance holes for $\phi < 24$ or 3 mm clearance holes for $\phi < 24$.
- Bearing values shown in **bold** are less than the single shear capacity of the bolt.
- Bearing values shown in *italic* are less than the double shear capacity of the bolt.
- Multiply tabulated bearing values by 0.7 if oversized or short slotted holes are used.
- Multiply tabulated bearing values by 0.5 if kidney shaped or long slotted holes are used.
- Shear capacity should be reduced for large packing, grip lengths or long joints.

Bolted connection capacity check for combined tension and shear

$$\frac{f_t}{P_t} + \frac{f_s}{P_s} \leq 1.4$$

Stainless steel to BS 5950

Stainless steels are a family of corrosion and heat resistant steels containing a minimum of 10.5% chromium which results in the formation of a very thin self-healing transparent skin of chromium oxide – which is described as a passive layer. Alloy proportions can be varied to produce different grades of material with differing strength and corrosion properties. The stability of the passive layer depends on the alloy composition. There are five basic groups: austenitic, ferritic, duplex, martensitic and precipitation hardened. Of these, only austenitic and Duplex are really suitable for structural use.

Austenitic

Austenitic is the most widely used for structural applications and contains 17–18% chromium, 8–11% nickel and sometimes molybdenum. Austenitic stainless steel has good corrosion resistance, high ductility and can be readily cold formed or welded. Commonly used alloys are 304L (European grade 1.4301) and 316L (European grade 1.4401).

Duplex

Duplex stainless steels are so named because they share the strength and corrosion resistance properties of both the austenitic and ferritic grades. They typically contain 21–26% chromium, 4–8% nickel and 0.1–4.5% molybdenum. These steels are readily weldable but are not so easily cold rolled. Duplex stainless steel is normally used where an element is under high stress in a severely corrosive environment. A commonly used alloy is Duplex 2205 (European grade 1.44062).

Material properties

The material properties vary between cast, hot rolled and cold rolled elements.

Density	78–80 kN/m ³
Tensile strength	200–450 N/mm ² 0.2% proof stress depending on grade.
Poisson's ratio	0.3
Modulus of elasticity	<i>E</i> varies with the stress in the section and the direction of the stresses. As the stress increases, the stiffness decreases and therefore deflection calculations must be done on the basis of the secant modulus.
Shear modulus	76.9 kN/mm ²
Linear coefficient of thermal expansion	17 × 10 ⁻⁶ /°C for 304L (1.4301) 16.5 × 10 ⁻⁶ /°C for 316L (1.4401) 13 × 10 ⁻⁶ /°C for Duplex 2205 (1.4462)
Ductility	Stainless steel is much tougher than mild steel and so BS 5950 does not apply any limit on the thickness of stainless steel sections as it does for mild steel.

Elastic properties of stainless steel alloys for design

The secant modulus, $E_s = \frac{(E_{s1} + E_{s2})}{2}$, where

$$E_{si} = \frac{E}{\left(1 + k \left(\frac{f_i}{P_y}\right)^m\right)}$$

where $i = 1$ or 2 , $k = 0.002E/P_y$ and m is a constant.

Values of the secant modulus are calculated below for different stress ratios (f_i/P_y)

Values of secant modulus for selected stainless steel alloys for structural design

Stress ratio* $\frac{f_i}{P_y}$	Secant modulus kN/mm ²					
	304L		316L		Duplex 2205	
	Longitudinal	Transverse	Longitudinal	Transverse	Longitudinal	Transverse
0.0	200	200	190	195	200	205
0.2	200	200	190	195	200	205
0.3	199	200	190	195	199	204
0.4	197	200	188	195	196	200
0.5	191	198	184	193	189	194
0.6	176	191	174	189	179	183
0.7	152	173	154	174	165	168

*Where $i = 1$ or 2 for the applied stress in the tension and compression flanges respectively.

Typical stock stainless steel sections

There is no UK-based manufacturer of stainless steel and so all stainless steel sections are imported. Two importers who will send out information on the sections they produce are Valbruna and IMS Group. The sections available are limited. IMS has a larger range including hot rolled equal angles (from $20 \times 20 \times 3$ up to $100 \times 100 \times 10$), unequal angles ($20 \times 10 \times 3$ up to $200 \times 100 \times 13$), I beams (80×46 up to 400×180), H beams (50×50 up to 300×300), channels (20×10 up to 400×110) and tees ($20 \times 20 \times 3$ up to $120 \times 120 \times 13$) in 1.4301 and 1.4571. Valbruna has a smaller selection of plate, bars and angles in 1.4301 and 1.4404.

Source: Nickel Development Institute (1994).

Durability and fire resistance

Suggested grades of stainless steel for different atmospheric conditions

Stainless steel grade	Location											
	Rural			Urban			Industrial			Marine		
	Low	Med	High	Low	Med	High	Low	Med	High	Low	Med	High
304L (1.4301)	✓	✓	✓	✓	✓	(✓)	(✓)	(✓)	X	✓	(✓)	X
316L (1.4401)	O	O	O	O	✓	✓	✓	✓	(✓)	✓	✓	(✓)
Duplex 2205 (1.4462)	O	O	O	O	O	O	O	O	✓	O	O	✓

Where: ✓ = optimum specification, (✓) = may require additional protection, X = unsuitable, O = overspecified.

Note that this table does not apply to chlorinated environments which are very corrosive to stainless steel. Grade 304L (1.4301) can tarnish and is generally only used where aesthetics are not important; however, marine Grade 316L (1.4401) will maintain a shiny surface finish.

Corrosion mechanisms

Durability can be reduced by heat treatment and welding. The surface of the steel forms a self-healing invisible oxide layer which prevents ongoing corrosion and so the surface must be kept clean and exposed to provide the oxygen required to maintain the corrosion resistance.

Pitting Mostly results in the staining of architectural components and is not normally a structural problem. However, chloride attack can cause pitting which can cause cracking and eventual failure. Alloys rich in molybdenum should be used to resist chloride attack.

Crevice corrosion Chloride attack and lack of oxygen in small crevices, e.g. between nuts and washers.

Bi-metallic effects The larger the cathode, the greater the rate of attack. Mild steel bolts in a stainless steel assembly would be subject to very aggressive attack. Austenitic grades typically only react with copper to produce an unsightly white powder, with little structural effect. Prevent bi-metallic contact by using paint or tape to exclude water as well as using isolation gaskets, nylon/Teflon bushes and washers.

Fire resistance

Stainless steels retain more of their strength and stiffness than mild steels in fire conditions, but typically as stainless steel structure is normally exposed, its fire resistance generally needs to be calculated as part of a fire engineered scheme.

Source: Nickel Development Institute (1994).

Preliminary sizing

Assume a reduced Young's modulus depending on how heavily stressed the section will be and assume an approximate value of maximum bending stress for working loads of 130 N/mm^2 . A section size can then be selected for checking to BS 5950.

Stainless steel design to BS 5950: Part 1

The design is based on ultimate loads calculated on the same partial safety factors as for mild steel.

Ultimate mechanical properties for stainless steel design to BS 5950

Alloy type	Steel designation	European grade (UK grade)	Minimum 0.2% proof stress N/mm^2	Ultimate tensile strength N/mm^2	Minimum elongation after fracture %
Basic austenitic ¹	X5CrNi 18-9	304L (1.4301)	210	520–720	45
	Molybdenum austenitic ²	X2CrNiMo 17-12-2	316L (1.4401)	220	520–670
Duplex		X2CrNi MoN 22-5-3	Duplex 2205 (1.4462)	460	640–840

NOTES:

1. Most commonly used for structural purposes.
2. Widely used in more corrosive situations.

The alloys listed in the table above are low carbon alloys which provide good corrosion resistance after welding and fabrication.

As for mild steel, the element cross section must be classified to BS 5950: Part 1 in order to establish the appropriate design method. Generally this method is as given for mild steels; however, as there are few standard section shapes, the classification and design methods can be laborious.

Source: Nickel Development Institute (1994).

Connections

Bolted and welded connections can be used. Design data for fillet and butt welds requires detailed information about which particular welding method is to be used. The information about bolted connections is more general.

Bolted connections

Requirements for stainless steel fasteners are set out in BS EN ISO 3506 which split fixings into three groups: A = Austenitic, F = Ferritic and C = Martensitic. Grade A fasteners are normally used for structural applications. Grade A2 is equivalent to Grade 304L (1.4301) with a 0.2% proof stress of 210 N/mm² and Grade A4 is equivalent to Grade 316L (1.4401) with a 0.2% proof stress of 450 N/mm². There are three further property classes within Grade A: 50, 70 and 80 to BS EN ISO 3506. An approximate ultimate bearing strength for connected parts can be taken as 460 N/mm² for preliminary sizing.

Ultimate stress values for bolted connection design

Grade A property class	Shear strength* N/mm ²	Bearing strength* N/mm ²	Tensile strength* N/mm ²
50	140	510	210
70 (most common)	310	820	450
80	380	1000	560

* These values are appropriate with bolt diameters less than M24 and bolts less than 8 diameters long.

Sources: Nickel Development Institute (1994).

10

Composite Steel and Concrete

Composite steel and concrete flooring, as used today, was developed in the 1960s to economically increase the spans of steel framed floors while minimizing the required structural depths.

Composite flooring elements

Concrete slab There are various types of slab: solid in situ, in situ on profiled metal deck and in situ on precast concrete units. Solid slabs are typically 125–150 mm thick and require formwork. The precast and metal deck systems both act as permanent formwork, which may need propping to control deflections. The profiled metal deck sheets have a 50–60 mm depth to create a 115–175 mm slab, which can span 2.5 to 3.6 m. Precast concrete units 75–100 mm thick with 50–200 mm topping can span 3–8 m.

Steelwork Generally the steel section is sized to support the wet concrete and construction loads with limited deflection, followed by the full design loading on the composite member. Secondary beams carry the deck and are in turn supported on primary beams which are supported on the columns. The steel beams can be designed as simply supported or continuous. Long span beams can be adversely affected by vibration, and should be used with caution in dynamic loading situations.

Shear studs Typically 19 mm diameter and 95 mm or 120 mm tall. Other heights for deep profiled decks are available with longer lead times. Larger diameter studs are available but not many subcontractors have the automatic welding guns to fix them. Welded studs will carry about twice the load of proprietary ‘shot fired’ studs.

Economic arrangement Secondary beam spacing is limited to about arrangement 2.5–3 m in order to keep the slab thickness down and its fire resistance up. The most economic geometrical arrangement is for the primary span to be about 3/4 of the secondary span.

Summary of material properties

The basic properties of steel and concrete are as set out in their separate sections.

Concrete grade	Normal weight concrete RC 30–50 and lightweight concrete RC 25–40.	
Density	Normal weight concrete 24 kN/m ³ and lightweight concrete 17 kN/m ³ .	
Modular ratio ($\alpha_E = E_S/E_C$)	Normal concrete	$\alpha_E = 6$ short term and $\alpha_E = 18$ long term.
	Lightweight concrete	$\alpha_E = 10$ short term $\alpha_E = 25$ long term.
Steel grade	S275 is used where it is required in small quantities (less than 40 tonnes) or where deflection, not strength, limits the design. Otherwise S355 is more economical, but will increase the minimum number of shear studs which are required by the code.	

Durability and fire resistance

- The basic durability requirements of steel and concrete are as set out in their separate sections.
- Concrete slabs have an inherent fire resistance. The slab thickness may be controlled by the minimum thickness required for fire separation between floors, rather than by deflection or strength.
- Reinforcing mesh is generally added to the top face of the slab to control surface cracking. The minimum required is 0.1 per cent of the concrete area, but more may be required for continuous spans or in some fire conditions.
- Additional bars are often suspended in the troughs of profiled metal decks to ensure adequate stability under fire conditions. Deck manufacturers provide guidance on bar areas and spacing for different slab spans, loading and thickness for different periods of fire resistance.
- Precast concrete composite planks have a maximum fire resistance of about 2 hours.
- The steel frame has to be fire and corrosion protected as set out in the section on structural steelwork.

Preliminary sizing of composite elements

Typical span/depth ratios

Element	Typical spans m		Total structural depth (including slab and beams) for simply supported beams	
	Primary	Secondary	Primary	Secondary
Universal beam sections	6–10	8–18	$L/19$	$L/23$
Universal column sections	6–10	8–18	$L/22$	$L/29$
Fabricated sections	>12	>12	$L/15$	$L/25$
Fixed end/haunched beams (Haunch length $L/10$ with maximum depth $2D$)	>12	>12	$L/25$ (midspan)	$L/32$ (midspan)
Castellated beams (Circular holes $\phi = 2D/3$ at about 1.5ϕ c/c, D is the beam depth)	n/a	6–16	$L/17$	$L/20$
Proprietary composite trusses	>12	>12	$L/12$	$L/16$

Preliminary sizing

Estimate the unfactored moment which will be applied to the beam in its final (rather than construction) condition. Use an allowable working stress of 160 N/mm^2 for S275, or 210 N/mm^2 for S355, to estimate the required section modulus (Z) for a non-composite beam. A preliminary estimate of a composite beam size can be made by selecting a steel beam with 60–70% of the non-composite Z . Commercial office buildings normally have about 1.8 to 2.2 shear studs (19 mm diameter) per square metre of floor area. Deflections, response to vibration and service holes should be checked for each case.

Approximate limits on holes in rolled steel beams

Reduced section capacity due to holes through the webs of steel beams must be considered for both initial and detailed calculations.

Where D is the depth of the steel beam, limit the size of openings to $0.6D$ depth and $1.5D$ length in unstiffened webs, and to $0.7D$ and $2D$ respectively where stiffeners are provided above and below the opening. Holes should be a minimum of $1.5D$ apart and be positioned centrally in the depth of the web, in the middle third of the span for uniformly loaded beams. Holes should be a minimum of D from any concentrated loads and $2D$ from a support position. Should the position of the holes be moved off centre of depth of the beam, the remaining portions of web above and below the hole should not differ by a factor of 1.5 to 2.

Preliminary composite beam sizing tables for S275 and normal weight concrete

4 kN/m² live loading + 1 kN/m² for partitions

Primary span m	Secondary span m	No. of secondary beams per grid	Secondary beam spacing m	Beam sizes for minimum steel weight			Beam sizes for minimum floor depth		
				Primary beam	Secondary beam	Steel weight kN/m ³	Primary beam	Secondary beam	Steel weight kN/m ³
6	8	2	3.00	457 × 152 UB 67	406 × 178 UB 54	0.26	254 × 254 UC 132	254 × 254 UC 132	0.61
	12	2	3.00	533 × 210 UB 92	610 × 229 UB 113	0.45	305 × 305 UC 158	356 × 406 UC 287	1.09
	15	2	3.00	610 × 229 UB 101	762 × 267 UB 173	0.64	305 × 305 UC 198	356 × 406 UC 551	1.97
8	8	3	2.67	533 × 210 UB 92	356 × 171 UB 57	0.33	305 × 305 UC 198	254 × 254 UC 107	0.65
	12	3	2.67	610 × 229 UB 125	610 × 229 UB 101	0.48	305 × 305 UC 283	305 × 305 UC 283	1.30
	15	3	2.67	762 × 267 UB 147	762 × 267 UB 173	0.75	356 × 406 UC 287	356 × 406 UC 467	1.94
9	8	3	3.00	610 × 229 UB 101	406 × 178 UB 54	0.31	305 × 305 UC 240	254 × 254 UC 132	0.74
	12	3	3.00	686 × 254 UB 140	610 × 229 UB 113	0.49	356 × 406 UC 287	356 × 406 UC 287	1.20
	15	3	3.00	762 × 267 UB 173	762 × 267 UB 173	0.69	356 × 406 UC 393	356 × 406 UC 551	2.10
10	8	4	2.50	686 × 254 UB 140	356 × 171 UB 57	0.40	356 × 406 UC 287	254 × 254 UC 107	0.79
	12	4	2.50	838 × 292 UB 176	610 × 229 UB 101	0.55	356 × 406 UC 393	305 × 305 UC 283	1.46
	15	4	2.50	914 × 305 UB 201	762 × 267 UB 173	0.83	356 × 406 UC 467	356 × 406 UC 467	2.18
12	8	4	3.00	762 × 267 UB 173	406 × 178 UB 54	0.40	356 × 406 UC 467	254 × 254 UC 132	0.93
	12	4	3.00	914 × 305 UB 224	610 × 229 UB 113	0.56	356 × 406 UC 634	356 × 406 UC 287	1.49
	15	4	3.00	914 × 305 UB 289	762 × 267 UB 173	0.77	914 × 419 UB 289	356 × 406 UC 551	2.01

Check floor natural frequency <4.5 Hz

Construction deflections limited to span / 360 or 25 mm

Preliminary composite beam sizing tables for S275 and lightweight concrete

4 kN/m² live loading+ 1 kN/m² for partitions

Primary span m	Secondary span m	No. of secondary beams per grid	Secondary beam spacing m	Minimum steel weight			Minimum floor depth		
				Primary beam	Secondary beam	Steel weight kN/m ³	Primary beam	Secondary beam	Steel weight kN/m ³
6	8	2	3.00	457 × 152 UB 60	356 × 171 UB 57	0.27	254 × 254 UC 89	254 × 254 UC 89	0.41
	12	2	3.00	533 × 210 UB 82	533 × 210 UB 109	0.43	254 × 254 UC 132	305 × 305 UC 240	0.91
	15	2	3.00	533 × 210 UB 92	762 × 267 UB 147	0.55	305 × 305 UC 158	356 × 406 UC 467	1.66
8	8	3	2.67	457 × 152 UB 82	356 × 171 UB 51	0.29	305 × 305 UC 158	254 × 254 UC 89	0.53
	12	3	2.67	610 × 229 UB 101	533 × 210 UB 101	0.46	305 × 305 UC 240	305 × 305 UC 240	1.10
	15	3	2.67	610 × 229 UB 125	762 × 267 UB 134	0.59	305 × 305 UC 283	356 × 406 UC 393	1.66
9	8	3	3.00	610 × 229 UB 101	356 × 171 UB 57	0.32	305 × 305 UC 198	254 × 254 UC 89	0.54
	12	3	3.00	610 × 229 UB 125	533 × 210 UB 109	0.47	305 × 305 UC 283	305 × 305 UC 240	1.04
	15	3	3.00	762 × 267 UB 147	762 × 267 UB 147	0.59	356 × 406 UC 287	356 × 406 UC 467	1.75
10	8	4	2.50	610 × 229 UB 125	356 × 171 UB 51	0.36	305 × 305 UC 240	254 × 254 UC 89	0.66
	12	4	2.50	762 × 267 UB 147	533 × 210 UB 101	0.53	356 × 406 UC 287	305 × 305 UC 240	1.20
	15	4	2.50	838 × 292 UB 176	762 × 267 UB 134	0.65	356 × 406 UC 340	356 × 406 UC 393	1.80
12	8	4	3.00	762 × 267 UB 147	356 × 171 UB 57	0.37	356 × 406 UC 393	254 × 254 UC 89	0.79
	12	4	3.00	838 × 292 UB 194	533 × 210 UB 109	0.53	356 × 406 UC 551	305 × 305 UC 240	1.26
	15	4	3.00	914 × 305 UB 224	762 × 267 UB 147	0.64	356 × 406 UC 634	356 × 406 UC 467	1.98

Check floor natural frequency <4.5 Hz

Composite design to BS 5950

BS 5950: Part 3 is based on ultimate loads and plastic design of sections, so the partial safety factors and design strengths of steel as BS 5950: Part 1 and BS 8110: Part 1 apply as appropriate. Steel sections should be classified for local buckling to determine whether their design should be plastic or elastic.

The composite moment capacity depends on the position of the neutral axis – whether in the concrete slab, the steel flange or the steel web. This depends on the relative strength of the concrete and steel sections. The steel beam should be designed for the non-composite temporary construction situation as well as for composite action in the permanent condition.

The code design methods are very summarized for this book, which only deals with basic moment capacity in relation to uniform loads. The code also provides guidance on how concentrated loads and holes in beams should be designed for in detail. Serviceability and vibration checks are also required.

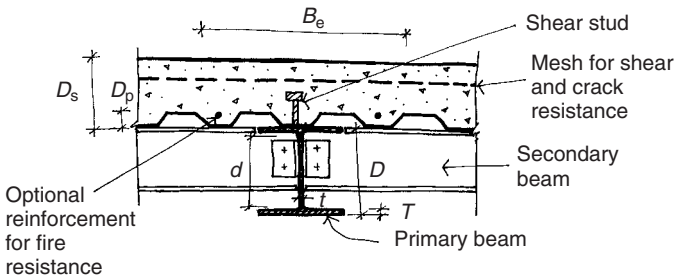

Effective slab breadth

Internal secondary beams: $B_e =$ the lesser of secondary beam spacing or $L/4$.

Internal primary beams: $B_e =$ the lesser of $0.8 \times$ secondary beam spacing or $L/4$

Edge beams: $B_e =$ half of the appropriate primary or secondary value.

Composite plastic moment capacity for simply supported beams

Assuming that the steel section is compact and uniformly loaded, check that the applied moment is less than the plastic moment of the composite section. These equations are for a profiled metal deck slab where the shear is low ($F_v < 0.5P_v$):

Compression capacity of concrete slab, $R_c = 0.45 f_{cu} B_e (D_s - D_p)$

Tensile capacity of steel element, $R_s = \rho_y A_{\text{area of steel section}}$

Tensile capacity of one steel flange (thickness T), $R_f = A_{\text{area of flange}} \rho_y$

Tensile capacity of steel web (thickness t and clear depth d), $R_w = \rho_y A_{\text{area of web}}$

Moment capacity of the fully restrained steel section, M_s

Plastic moment capacity of the composite section, M_c

Plastic moment capacity of the composite section after deduction of the shear area, M_f

Applied shear stress, F_v

Shear capacity, P_v

Plastic moment capacity for low shear – neutral axis in concrete slab: $R_c \geq R_s$

$$M_c = R_s \left(\frac{D}{2} + D_s - \frac{R_s(D_s - D_p)}{2R_c} \right)$$

Plastic moment capacity for low shear – neutral axis in steel flange: $R_s > R_c \geq R_w$

$$M_c = \frac{R_s D}{2} + \frac{R_c(D_s + D_p)}{2} - \frac{T(R_s + R_c)^2}{4R_f}$$

Plastic moment capacity for low shear – neutral axis in steel web: $R_c < R_w$

$$M_c = M_s + \frac{R_c(D + D_s + D_p)}{2} - \frac{dR_c^2}{4R_w}$$

Reduced plastic moment capacity for combined high shear and moment

$$M_{cv} = M_c - (M_c - M_f) \left(\frac{2F_v}{P_v} - 1 \right)^2$$

Shear capacity

The shear capacity of the beam

$$P_v = 0.6 p_v A_v$$

Shear is considered low if the applied vertical shear load $F_v < 0.5P_v$. However, in simply supported beams, high shear and moment forces normally only coexist at the positions of heavy point loads. Therefore generally where there are no point loads and if $M_{\text{applied}} < M_c$ and $F_v < P_v$, no further checks are required.

For high shear, $F_v > 0.5P_v$, the web of the steel beam must be neglected from calculations for the reduced moment capacity, M_{cv} .

Longitudinal shear

Shear stud strengths for normal weight concrete are given in Table 5 of BS 5950: Part 3. Studs of 19 mm diameter have characteristic resistances of 80 kN to 100 kN for normal weight concrete, depending on the height and the concrete strength. The strength of the studs in lightweight concrete can be taken as 90% of the normal concrete weight values. Allowances and reductions must be made for groups of studs as well as the deck shape and its contact area (due to the profiled soffit) with the steel beam. The horizontal shear force on the interface between the steel and concrete should be estimated and an arrangement of shear studs selected to resist that force. The minimum spacing of studs is 6ϕ longitudinally and 4ϕ transversely, where ϕ is the stud diameter and the maximum longitudinal spacing of the studs is 600 mm.

Mesh reinforcement is generally required in the top face of the slab to spread the stud shear forces across the effective breadth of the slab (therefore increasing the longitudinal shear resistance) and to minimize cracking in the top of the slab.

Serviceability

For simply supported beams the second moment of area can be calculated on the basis of the midspan breadth of the concrete flange, which is assumed to be uncracked.

The natural frequency of the structure can be estimated by $f = 18/\sqrt{\delta}$ where δ is the elastic deflection (in mm) under dead and permanent loads. In most cases problems due to vibrations can be avoided as the natural frequency of the floor is kept greater than 4 Hz–4.5 Hz.

11

Structural Glass

Structural glass assemblies are those in which the self-weight of the glass, wind and other imposed loads are carried by the glass itself rather than by glazing bars, mullions or transoms, and the glass elements are connected together by mechanical connections or by adhesives.

Despite the increasing use of glass as a structural material over the last 25 years, there is no single code of practice which covers all of the issues relating to structural glass assemblies. Therefore values for structural design must be based on first principles, research, experience and load testing. The design values given in this chapter should be used very carefully with this in mind.

The following issues should be considered:

- Glass is classed as a rigid liquid as its intermolecular bonds are randomly arranged, rather than the crystalline arrangement normally associated with solids. Glass will behave elastically until the applied stresses reach the level where the interatomic bonds break. If sufficient stress is applied, these cracks will propagate and catastrophic failure will occur. The random arrangement of the interatomic bonds means that glass is not ductile and therefore failure is sudden.
- Cracks in glass propagate faster as temperature increases.
- Without the ability to yield, or behave plastically, glass can fail due to local over-stressing. Steel can redistribute high local stresses by local yielding and small plastic deformations, but glass cannot behave like this and high local stresses will result in brittle failure.
- Modern glass is not thought to deform or creep under long-term stresses. It behaves perfectly elastically and will return to its original shape when applied loads are removed. However, some old glass has been found to creep.
- Glass will generally fail as a result of the build-up of tensile stresses. Generally it is the outer surfaces of the glass which are subject to these stresses. Small flaws on glass surfaces encourage crack propagation which can lead to failure. Structural glass should be carefully checked for flaws.
- Annealed glass can also fail as a result of 'static fatigue'. There are various theories on why this occurs, but in simple terms, microcracks form and propagate under sustained loads resulting in failure of the glass. This means that the strength of glass is time dependent; in the short term glass can carry about twice the load that it can carry in the long term. Long-term stresses are kept low in design to prevent propagation of cracks. There is a finite time for static fatigue failure to occur for each type of glass and although this is beyond the scope of this book, this period can be calculated. It is about 15 days for borosilicate glass (better known as Pyrex), but is generally much longer for annealed glass.
- Thermal shock must also be considered for annealed glass. Temperature differences across a single sheet of glass can result in internal stresses. Glass elements which are partly in direct sunlight and partly shaded are at most risk of failure. Thermal shock cracks tend to start at the edge of the glass, travelling inwards at about 90°, but this type of failure can depend on many things including edge restraint, and manufacturers should be consulted for each situation. If thermal shock is expected to be an issue, toughened or tempered glass should be specified in place of annealed.
- Glass must come from a known and reliable source to provide reliable strength and minimal impurities.

Types of glass products

Annealed/float glass

Glass typically consists of frit: sand (silica 72%), soda ash (sodium carbonate 13%), limestone (calcium carbonate 10%) and dolomite (calcium magnesium carbonate 4%). This mixture is combined with broken glass (called cullet) at about 80% frit to 20% cullet, and is heated to 1500°C to melt it. It leaves the first furnace at about 1050°C and goes on to the forming process.

There are a number of forming processes, but structural glass is generally produced by the float glass method, which was developed in 1959 by Pilkington. The molten glass flows out of the furnace on to a bed of molten tin in a controlled atmosphere of nitrogen and oxygen and is kept at high temperature. This means that defects and distortions are melted out of the upper and lower surfaces without grinding and polishing. The glass is progressively cooled as it is moved along the bath by rollers until it reaches about 600°C when the glass sheet becomes viscous enough to come into contact with the rollers without causing damage to the bottom surface. The speed at which the ribbon of glass moves along the tin bath determines the thickness of the glass sheet. Finally the glass is cooled in a gradual and controlled manner to 200°C in the annealing bay. The term 'annealed' means that the glass has been cooled carefully to prevent the build-up of residual stresses. The surfaces of float glass can be described by using the descriptions 'tin side' and 'air side' depending on which way the glass was lying in the float bath. For use as structural glass, the material should be free of impurities and discoloration. At failure, annealed glass typically breaks into large pieces with sharp edges. Annealed glass must therefore be specified carefully so that on failure it will not cause injury.

Toughened/fully tempered glass

Sheets of annealed glass are reheated to their softening point at about 700°C before being rapidly cooled. This can be done by hanging the glass vertically gripped by tongs with cooling applied by air jets, or by rolling the glass through the furnace and cooling areas. The rapid cooling of the glass causes the outer surfaces to contract quicker than the inner core. This means that a permanent precompression is applied to the glass, which can make its capacity for tensile stress three to four times better than annealed glass. The strength of toughened glass can depend on its country of origin. The values quoted in this book relate to typical UK strengths. The 'tin side' of toughened glass can be examined using polarizing filters to determine the residual stresses and hence the strength of the glass. Toughened glass cannot be cut or drilled after toughening, therefore glass is generally toughened for specific projects rather than being kept as a stock item. Toughened glass is more resistant to temperature differentials within elements than annealed glass and therefore it tends to be used externally in elements such as floors where annealed glass would normally be used in internal situations. Toughened glass can fail as a result of nickel sulphide impurities as described in the section on 'Heat soaked glass'. If specified to BS 6206, toughened glass is regarded as a safety glass because it fractures into small cubes (40 particles per 50 mm square) without sharp edges when broken. However, these cubes have the same density as crushed concrete and the design should prevent broken glass falling out of place to avoid injury to the public.

Partly toughened/heat tempered glass

Sheets of annealed glass are heated and then cooled in the same way as the toughening process; however, the cooling is not as rapid. This means that slightly less permanent precompression is applied to the glass, which will make its capacity for tensile stress 1.5 to 2 times better than annealed glass. The residual strength can be specified depending on the proposed use. Heat tempered glass will not fail as a result of nickel sulphide impurities as described for toughened glass in the section on 'Heat soaked glass'. The fracture pattern is very like that of annealed glass, as the residual stresses are not quite enough to shatter the glass into the small cubes normally associated with toughened glass. Tempered glass can be laminated to the top of toughened glass to produce units resistant to thermal shock, which can remain in place with a curved shape even when both sheets of glass have been broken.

Heat soaked glass

The float glass process leaves invisible nickel sulphide (NS) impurities in the glass called inclusions. When the glass is toughened, the heat causes these inclusions to become smaller and unstable. After toughening, and often after installation, thermal movements and humidity changes can cause the NS inclusions in the glass to revert to their original form by expanding. This expansion causes the glass to shatter and failure can be quite explosive. Heat soaking can be specified to reduce the risk of NS failure of toughened glass by accelerating the natural phenomenon. This accelerated fatigue will tend to break flawed glass during a period of prolonged heating at about 300°C. Heat soaking periods are the subject of international debate and range between 2 and 8 hours. The German DIN standard is considered the most reliable code of practice. Glass manufacturers indicate that one incidence of NS failure is expected in every 4 tonnes of toughened glass, but after heat soaking this is thought to reduce to about 1 in 400 tonnes.

Laminated glass

Two or more sheets of glass are bonded, or laminated, together using plastic sheet or liquid resin interlayers. The interlayer is normally polyvinyl butyral (PVB) built up in sheets of 0.38 mm and can be clear or tinted. It is normal to use four of these layers (about 12 mm) in order to allow for the glass surface ripple which is produced by the rollers used in the float glass manufacturing process. Plastic sheets are used for larger numbers and sizes of panels. Liquid resins are more suited to curved glass and to small-scale manufacturing, as the glass sheets have to be kept spaced apart in order to obtain a uniform thickness of resin between the sheets. The bonding is achieved by applying heat and pressure in an autoclave. If the glass breaks in service, the interlayer tends to hold the fragmented glass to the remaining sheet until the panel can be replaced. Laminates can be used for safety, bullet proofing, solar control and acoustic control glazing. Toughened, tempered, heat soaked and annealed glass sheets can be incorporated and combined in laminated panels. Ideally the glass should be specified so that toughened or tempered glass is laminated with the 'tin side' of the glass outermost, so that the glass strength can be inspected if necessary. Laminated panels tend to behave monolithically for short time loading at temperatures below 70°C, but interlayer creep means that the layers act separately under long-term loads.

Summary of material properties

Density 25–26 kN/m³

Compressive strength $F_{cu} = 1000 \text{ N/mm}^2$

Tensile strength Strength depends on many factors including: duration of loading, rate of loading, country of manufacture, residual stresses, temperature, size of cross section, surface finish and micro cracks. Fine glass fibres have tensile strengths of up to 1500 N/mm² but for the sections used in structural glazing, typical characteristic tensile strengths are: 45 N/mm² for annealed, 80 N/mm² for tempered glass and 120 N/mm² for toughened. Patterned or wired glass can carry less load.

Modulus of elasticity 70–74 kN mm²

Poisson's ratio 0.22–0.25

Linear coefficient of thermal expansion $8 \times 10^{-6} / ^\circ\text{C}$

Typical glass section sizes and thicknesses

The range of available glass section sizes changes as regularly as the plant and facilities in the glass factories are updated or renewed. There are no standard sizes, only maximum sizes. Manufacturers should be contacted for up to date information about the sheet sizes available. The contact details for Pilkington, Solaglass Saint Gobain, Firman, Hansen Glass, QTG, European, Bishoff Glastechnik and Eckelt are listed in the chapter on useful addresses. Always check that the required sheet size can be obtained and installed economically.

Annealed/float glass

The typical maximum size is 3210 mm × 6000 mm although sheets up to 3210 mm × 8000 mm can be obtained on special order or from continental glass manufacturers.

Typical float glass thicknesses

Thickness mm	3*	4	5*	6	8*	10	12	15	19	25
Weight kg/m²	7.5	10.0	12.5	15.0	20.0	25.0	30.0	37.5	47.5	62.5

* Generally used in structural glazing laminated units.

Toughened/fully tempered glass

The sizes of toughened sheets are generally smaller than the sizes of float glass available. Toughened glass in 25 mm is currently still only experimental and is generally not available.

Thickness mm	4	5	6	8	10	12	15	19
Sheet size* mm × mm	1500 × 2200	2000 × 4200	2000 × 4200	2000 × 4200	2000 × 4200	2000 × 4200	1700 × 4200	1500 × 4200

* Larger sizes are available from certain UK and European suppliers.

Heat tempered/partly toughened glass

Normally only produced in 8 mm thick sheets for laminated units. Manufacturers should be consulted about the availability of 10 mm and 12 mm sheets. Sheet sizes are the same as those for fully toughened glass.

Heat soaked glass

Sheet sizes are limited to the size of the heat soaking oven, typically about 2000 mm × 6000 mm.

Laminated glass

Limited only by the size of sheets available for the different types of glass and the size of autoclave used to cure the interlayers.

Curved glass

Curved glass can be obtained in the UK from Pilkington with a minimum radius of 750 mm for 12 mm glass; a minimum radius of 1000 mm for 15 mm glass and a minimum radius of 1500 mm for 19 mm glass. However, Sunglass in Italy and Cricursa in Spain are specialist providers who can provide a minimum radius of 300 mm for 10 mm glass down to 100 mm for 4 mm to 6 mm glass.

Durability and fire resistance

Durability

Glass and stainless steel components are inherently durable if they are properly specified and kept clean. Glass is corrosion resistant to most substances apart from strong alkalis. The torque of fixing bolts and the adhesives used to secure them should be checked approximately every 5 years and silicone joints may have to be replaced after 25–30 years depending on the exposure conditions. Deflection limits might need to be increased to prevent water ingress caused by rotations at the framing and sealing to the glass.

Fire resistance

Fire resistant glasses are capable of achieving 60 minutes of stability and integrity when specially framed using intumescent seals etc. There are several types of fire resisting glass which all have differing amounts of fire resistance. The wire interlayer in Georgian wired glass maintains the integrity of the pane by holding the glass in place as it is softened by the heat of a fire. Intumescent interlayers in laminated glass expand to form an opaque rigid barrier to contain heat and smoke. Prestressed borosilicate glass (better known as Pyrex) can resist heat without cracking but must be specially made to order and is limited to 1.2 m by 2 m panels.

Typical glass sizes for common applications

The following are typical sizes from Pilkington for standard glass applications. The normal design principles of determinacy and redundancy should also be considered when using these typical sizes. These designs are for internal use only. External use requires more careful consideration of thermal effects, where it may be more appropriate to specify toughened glass instead of annealed glass.

Toughened glass barriers

Horizontal line load kN/m	Toughened glass thickness* mm
0.36	12
0.74	15
1.50	19
3.00	25

* For 1.1 m high barrier, clamped at foot.

Toughened glass infill to barriers bolted between uprights

Loading		Limiting glass span for glass thickness m			
UDL kN/m ²	Point load kN	6 mm*	8 mm *	10 mm	12 mm
0.5	0.25	1.40	1.75	2.10	2.40
1.0	0.50	0.90	1.45	1.75	2.05
1.5	1.50	–	–	1.20	1.60

* Not suitable if free path beside barrier is >1.5 m as it will not contain impact loads as Class A to BS 6206.

Laminated glass floors and stair treads

UDL kN/m ²	Point load kN	Glass thickness (top + bottom annealed)* mm + mm	Typical use
1.5	1.4	19 + 10	Domestic floor or stair
5.0	3.6	25 + 15	Dance floor
4.0	4.5	25 + 25	Corridors
4.0	4.0	25 + 10	Stair tread

* Based on a floor sheet size of 1 m² or a stair tread of 0.3 × 1.5 m supported on four edges with a minimum bearing length equal to the thickness of the glass unit. The 1 m² is normally considered to be the maximum size/weight which can be practically handled on site.

Glass mullions or fins in toughened safety glass

Mullion height m	Mullion thickness/depth for wind loading mm*			
	1.00 kN/m ²	1.25 kN/m ²	1.50 kN/m ²	1.75 kN/m ²
<2.0	19/120	19/130	25/120	25/130
2.0–2.5	19/160	25/160	25/170	–
2.5–3.0	25/180	25/200	–	–
3.0–3.5	25/230	–	–	–
3.5–4.0	25/280	–	–	–

* Assuming restraint at head and foot plus sealant to main panels.

Glass walls and planar glazing

Suspended structural glass walls can typically be up to 23 m high and of unlimited length, while ground supported walls are usually limited to a maximum height of 9 m.

Planar glazing is limited to a height of 18 m with glass sheet sizes of less than 2 m² so that the weights do not exceed the shear capacity of the planar bolts and fixings.

In a sheltered urban area, 2 × 2 m square panels will typically need a bolt at each of the four corners; 2 × 3.5 m panels will need six bolts and panels taller than 3.5 m will need eight bolts.

Source: Pilkington (2002).

Structural glass design

Summary of design principles

- Provide alternative routes within a building so that users can choose to avoid crossing glass structures.
- Glass is perfectly elastic, but failure is sudden.
- Deflection and buckling normally govern the design. Deflections of vertical panes are thought to be acceptable to $\text{span}/150$, while deflections of horizontal elements should be limited to $\text{span}/360$.
- Glass works best in compression, although bearing often determines the thickness of beams and fins.
- For designs in pure tension, the supports should be designed to distribute the stresses uniformly across the whole glass area.
- Glass can carry bending both in and out of its own plane.
- Use glass in combination with steel or other metals to carry tensile and bending stresses.
- The sizes of glass elements in external walls can be dictated by energy efficiency regulations as much as the required strength.
- Keep the arrangement of supports simple, ensuring that the glass only carries predictable loads to avoid failure as a result of stress concentrations. Isolate glass from shock and fluctuating loads with spring and damped connections.
- Sudden failure of the glass elements must be allowed for in the design by provision of redundancy, alternative load paths, and by using the higher short-term load capacity of glass.
- Glass failure should not result in a disproportionate collapse of the structure.
- Generally long-term stresses in annealed glass are kept low to prevent failure as a result of static fatigue, i.e. time dependent failure. For complex structures with simple loading conditions, it is possible to stress glass elements for a calculated failure period in order to promote failure by static fatigue.
- The effects of failure and the method of repair or replacement must be considered in the design, as well as maintenance and access issues.
- The impact resistance of each element should be considered to establish an appropriate behaviour as a result of damage by accident or vandalism.
- It is good practice to laminate glass sheets used overhead. Sand blasting, etching and fritting can be used to provide slip resistance and modesty for glass to be used underfoot.
- Toughened glass elements should generally be heat soaked to avoid nickel sulphide failure if they are to be used to carry load as single or un laminated sheets.
- Consider proof testing elements/components if the design is new or unusual, or where critical elements rely on the additional strength of single ply toughened glass.
- Glass sheet sizes are limited to the standard sizes produced by the manufacturers and the size of sheets which cutting equipment can handle.
- When considering large sheet sizes, thought must be given to the practicalities of weight, method of delivery and installation and possible future replacement.
- Inspect glass delivered to site for damage or flaws which might cause failure.
- Check that the glass can be obtained economically, in the time available.

Codes of practice and design standards

There is no single code of practice to cover structural glass, although the draft Eurocode pr EN 13474 'Glass in Building' is the nearest to an appropriate code of practice for glass design. It is thought to be slightly conservative to account for the varying quality of glass manufacture coming from different European countries. Other useful references are BS 6262, Building Regulations Part N, Glass and Glazing Federation Data Sheets, Pilkington Design Guidance Sheets; the IStructE Guide to Structural Use of Glass in Buildings and the Australian standard AS 1288.

Glass can carry load in compression, tension, bending, torsion and shear, but the engineer must decide how the stresses in the glass are to be calculated, what levels of stress are acceptable, what factor of safety is appropriate and how can unexpected or changeable loads be avoided. Overdesign will not guarantee safety.

Although some design methods use fracture mechanics or Weibull probabilities, the simplest and most commonly used design approach is elastic analysis.

Guideline allowable stresses

The following values are for preliminary design using elastic analysis with unfactored loads and are based on the values available in pr EN 13474.

Glass type	Characteristic bending strength N/mm ²	Loading condition	Typical factor of safety	Typical allowable bending stress N/mm ²
Annealed	45	Long term	6.5	7
		Short term	2.5	20
Heat tempered	70	Long term	3.5	20
		Short term	2.4	30
Toughened	120	Long term	3.0	40
		Short term	2.4	50

Connections

Connections must transfer the load in and out of glass elements in a predictable way avoiding any stress concentrations. Clamped and friction grip connections are the most commonly used for single sheets. Glass surfaces are never perfectly smooth and connections should be designed to account for differences of up to 1 mm in the glass thickness. Cut edges can have tolerances of 0.2–0.3 mm if cut with a CNC laser, otherwise dimension tolerances can be 1.0–1.5 mm.

Simple supports

The sheets of glass should sit perfectly on to the supports, either in the plane, or perpendicular to the plane, of the glass. Gaskets can cause stress concentrations and should not be used to compensate for excessive deviation between the glass and the supports. The allowable bearing stress is generally limited to about $0.42\text{--}1.5\text{ N/mm}^2$ depending on the glass and setting blocks used.

Friction grip connections

Friction connections use patch plates to clamp the glass in place and are commonly used for single ply sheets of toughened glass. More complex clamped connections can use galvanized fibre gaskets and holes lined with nylon bushes to prevent stress concentrations. Friction grip bolt torques should be designed to generate a frictional clamping force of $N = F/\mu$, where the coefficient of friction is generally $\mu = 0.2$.

Holes

Annealed glass can be drilled. Toughened or tempered glass must be machined before toughening. The Glass and Glazing Federation suggest that the minimum clear edge distance should be the greater of 30 mm or 1.5 times the glass thickness (t). The minimum clear corner distance and minimum clear bolt spacing should be $4t$. Holes should be positioned in low stress areas, should be accurately drilled and the hole diameter must not be less than the glass thickness.

Bolted connections

Bolted connections can be designed to resist loads, both in and out of the plane of the glass. Pure bolted connections need to be designed for strength, tolerance, deflection, thermal and blast effects. They can be affected by minor details (such as drilling accuracy or the hole lining/bush) and this is why proprietary bolted systems are most commonly used. Extensive testing should be carried out where bolted connections are to be specially developed for a project.

Non silicon adhesives

The use of adhesives (other than silicon) is still fairly experimental and as yet is generally limited to small glass elements. Epoxies and UV cure adhesives are among those which have been tried. It is thought that failure strengths might be about ten times those of silicon, but suitable factors of safety have not been made widely available. Loctite and 3M have some adhesive products which might be worth investigating/testing.

Structural silicones

Sealant manufacturers should be contacted for assistance with specifying their silicon products. This assistance can include information on product selection, adhesion, compatibility, thermal/creep effects and calculation of joint sizes. Data from one project cannot automatically be used for other applications.

Structural silicon sealant joints should normally be a minimum of 6 mm × 6 mm, with a maximum width to depth ratio of 3:1. If this maximum width to depth ratio is exceeded, the glass sheets will be able to rotate causing additional stresses in the silicon. A simplified design approach to joint rotation can be used (if the glass deflection is less than $L/100$) where reduced design stresses are used to allow additional capacity in the joint to cover any rotational stresses. If joint rotation is specifically considered in the joint design calculations, higher values of allowable design stresses can be used.

Dow Corning manufacture two silicon adhesives for structural applications. Dow Corning 895 is one part adhesive, site applied silicon used for small-scale remedial applications or where a two-sided structurally bonded system has to be bonded on site. Dow Corning 993 is a two part adhesive, normally factory applied. The range of colours is limited and availability should be checked for each product and application.

Technical data on the Dow Corning silicones is set out below:

Dow Corning silicon	Young's modulus kN/mm ²	Type of stress	Failure stress N/mm ²	Loading condition	Typical allowable design stress N/mm ²
933 (2 part)	0.0014	Tension/ compression	0.95	Short-term/live loads. Design stress for comparison with simplified calculations not allowing for stresses due to joint rotation	0.140
				Short-term/live loads. Design stress where the stresses due to joint rotation for a particular case have been specifically calculated	0.210
				Long-term/dead loads	n/a
		Shear	0.68	Short-term/live loads Long-term/dead loads	0.105 0.011
895 (1 part)	0.0009	Tension/ compression	1.40	Short-term/live loads. Design stress for comparison with simplified calculations not allowing for stresses due to joint rotation	0.140
				Short-term/live loads. Design stress where the stresses due to joint rotation for a particular case have been specifically calculated	0.210
				Long-term/dead loads	n/a
		Shear	1.07	Short-term/live loads Long-term/dead loads	0.140 0.007

Source: Dow Corning (2002).

12

Building Elements, Materials, Fixings and Fastenings

Waterproofing

Although normally detailed and specified by an architect, the waterproofing must co-ordinate with the structure and the engineer must understand the implications of the waterproofing on the structural design.

Damp proof course

A damp proof course (DPC) is normally installed at the top and bottom of external walls to prevent the vertical passage of moisture through the wall. Cavity trays and weep holes are required above the position of elements which bridge the cavity, such as windows or doors, in order to direct any moisture in the cavity to the outside. The inclusion of a DPC will normally reduce the flexural strength of the wall.

DPCs should:

- Be bedded both sides in mortar to prevent damage.
- Be lapped with damp proof membranes in the floor or roof.
- Be lapped in order to ensure that moisture will flow over and not into the laps.
- Not project into cavities where they might collect mortar and bridge the cavity.

Different materials are available to suit different situations:

- Flexible plastic sheets or bitumen impregnated fabric can be used for most DPC locations but can be torn if not well protected and the bituminous types can sometimes be extruded under high loads or temperatures.
- Semi-rigid sheets of copper or lead are expensive but are most effective for intricate junctions.
- Rigid DPCs are layers of slate or engineering brick in Class I mortar and are only used in the base of retaining walls or freestanding walls. These combat rising damp and (unlike the other DPC materials) can transfer tension through the DPC position.

Damp proof membrane

Damp proof membranes (DPMs) are sheet or liquid membranes which are typically installed at roof and ground floor levels. In roofs they are intended to prevent the ingress of rain and at ground floor level they are intended to prevent the passage of moisture from below by capillary action. Sheet membranes can be polyethylene, bituminous or rubber sheets, while liquid systems can be hot or cold bitumen or epoxy resin.

Basement waterproofing

Basement waterproofing is problematic as leaks are only normally discovered once the structure has been occupied. The opportunity for remedial work is normally limited, quite apart from the difficulty of reaching externally applied tanking systems. Although an architect details the waterproofing for the rest of the building, sometimes the engineer is asked to specify the waterproofing for the basement. In this case very careful co-ordination of the lapping of the waterproofing above and below ground must be achieved to ensure that there are no weak points. Basement waterproofing should always be considered as a three-dimensional problem.

It is important to establish whether the system will be required to provide basic resistance to water pressure, or whether special additional controls on water vapour will also be required.

Basement waterproofing to BS 8102

BS 8102 sets out guidance for the waterproofing of basement structures according to their use. The following table has been adapted from Table 1 in BS 8102: 1990 to include some of the increased requirements suggested in CIRIA Report 139.

Methods of basement waterproofing

The following types of basement waterproofing systems can be used individually or together depending on the building requirements:

Tanked This can be used internally or externally using painted or sheet membranes. Externally it is difficult to apply and protect under building site conditions, while internally water pressures can blow the waterproofing off the wall; however, it is often selected as it is relatively cheap and takes up very little space.

Integral Concrete retaining walls can resist the ingress of water in differing amounts depending on the thickness of the section, the applied stresses, the amount of reinforcement and the density of the concrete. The density of the concrete is directly related to how well the concrete is compacted during construction. Integral structural waterproofing systems require a highly skilled workforce and strict site control. However, moisture and water vapour can still pass through a plain wall and additional protection should be added if this moisture will not be acceptable for the proposed basement use. BS 8007 provides guidance on the design of concrete to resist the passage of water, but this still does not stop water vapour. Alternatively, Calite or Pudlo additives can be used with a BS 8110 structure to create 'waterproof' concrete. This is more expensive than standard concrete but this can be offset against any saving on the labour and installation costs of traditional forms of waterproofing.

Drained Drained cavity and floor systems allow moisture to penetrate the retaining wall. The moisture is collected in a sump to be pumped away. Drained cavity systems tend to be expensive to install and can take up quite a lot of basement floor area, but they are thought to be much more reliable than other waterproofing systems. Draining ground water to the public sewers may require a special licence from the local water authority. Access hatches for the inspection and maintenance of internal gulleys should be provided where possible.

Basement waterproofing to BS 8102

Grade of basement to BS 8102	Basement use	Performance of water proofing	Form of construction	Comments
1	Car parking, plant rooms (excluding electrical equipment) and workshops	Some water seepage and damp patches tolerable (typical relative humidity >65%)	Type B – RC to BS 8110 (with crack widths limited to 0.3 mm)	Provides integral protection and needs waterstops at construction joints. Medium risk. Consider ground chemicals for durability and effect on finishes. The BS 8102 description of a workshop is not as good as the workshop environment described in the Building Regulations
2	Workshops and plantrooms requiring drier environment. Retail storage areas	No water penetration but moisture tolerable (typical relative humidity = 35–50%)	Type A	Requires drainage to external basement perimeter below the level of the wall/floor membrane lap. Medium risk with multiple membrane layers and strict site control
			Type B – RC to BS8007	Provides integral protection and needs waterstops at construction joints. Medium risk. Consider ground chemicals for durability and effect on finishes. Additional tanking is likely to be needed to meet retail storage requirements
3	Ventilated residential and working areas, offices, restaurants and leisure centres	Dry environment, but no specific control on moisture vapour (typical relative humidity 40–60%)	Type A	Not recommended unless drainage is provided above the wall/floor membrane lap position and the site is relatively free draining. High risk
			Type B – RC to BS 8007	Provides integral protection and needs waterstops at construction joints. Medium risk. Consider ground chemicals for durability and effect on finishes. Additional tanking is recommended
			Type C – wall and floor cavity system	A drained cavity allows the wall to leak and it is therefore foolproof. Sumps may need back-up pumps. High safety factor
4	Archives and computer stores	Totally dry environment with strict control of moisture vapour (typical relative humidity = 35% for books – 50% for art storage)	Type A	Unlikely to be able to provide the controlled conditions required. Very high risk
			Type B – RC to BS 8007 plus vapour barrier	High risk. Medium risk with addition of a drainage cavity to reduce water penetration
			Type C – wall and floor cavity system with vapour barrier to inner skin and floor cavity with DPM	Medium risk. Addition of a water resistant concrete wall would provide the maximum possible safety for sensitive environments

NOTES:

- Type A** = tanked construction, **Type B** = integral structural waterproofing and **Type C** = drained protection.
- Relative humidity indicates the amount of water vapour in the air as a percentage of the maximum amount of water vapour which would be possible for air at a given temperature and pressure. Typical values of relative humidity for the UK are about 40–50% for heated indoor conditions and 85% for unheated external conditions.

Source: BS 8102: 1990.

Remedial work

Failed basement systems require remedial work. Application of internal tanking in this situation is not normally successful. The junction of the wall and floor is normally the position where water leaks are most noticeable.

An economical remedial method is to turn the existing floor construction into a drained floor by chasing channels in the existing floor finishes around the perimeter. Additional channels may cross the floor where there are large areas of open space. Proprietary plastic trays with perforated sides and bases can be set into the chases, connected up and drained to a sump and pump. New floor finishes can then be applied over the original floor and its new drainage channels, to provide ground water protection with only a small thickness of additional floor construction.

Screeds

Screeds are generally specified by an architect as a finish to structural floors in order to provide a level surface, to conceal service routes and/or as a preparation for application of floor finishes. Historically screeds fail due to inadequate soundness, cracking and curling and therefore, like waterproofing, it is useful for the engineer to have some background knowledge. Structural toppings generally act as part of a precast structural floor to resist vertical load or to enhance diaphragm action. The structural issues affecting the choice of screed are: type of floor construction, deflection, thermal or moisture movements, surface accuracy and moisture condition.

Deflection

Directly bonded screeds can be successfully applied to solid reinforced concrete slabs as they are generally sufficiently rigid, while floating screeds are more suitable for flexible floors (such as precast planks or composite metal decking) to avoid reflective cracking of the screed. Floating screeds must be thicker than bonded screeds to withstand the applied floor loadings and are laid on a slip membrane to ensure free movement and avoid reflective cracking.

Thermal/moisture effects

Drying shrinkage and temperature changes will result in movement in the structure, which could lead to the cracking of an overlying bonded screed. It is general practice to leave concrete slabs to cure for 6 weeks before laying screed or applying rigid finishes such as tiles, stone or terrazzo. For other finishes the required floor slab drying times vary. If movement is likely to be problematic, joints should be made in the screed at predetermined points to allow expansion/contraction/stress relief.

Sand: cement screeds must be cured by close covering with polythene sheet for 7 days while foot traffic is prevented and the screed is protected from frost. After this the remaining free moisture in the screed needs time to escape before application of finishes. This is especially true if the substructure and finish are both vapour proof as this can result in moisture being trapped in the screed. Accurate prediction of screed drying times is difficult, but a rough rule is 4 weeks per 25 mm of screed thickness (to reach about 75% relative humidity). Accelerated heating to speed the drying process can cause the screed to crack or curl, but dehumidifiers can be useful.

Surface accuracy

The accuracy of surface level and flatness of a laying surface is related to the type of base, accuracy of the setting out and the quality of workmanship. These issues should be considered when selecting the overall thickness of the floor finishes to avoid problems with the finish and/or costly remedial measures.

Precast concrete hollowcore slabs

The values for the hollowcore slabs set out below are for precast prestressed concrete slabs by Tarmac Topfloor. The prestressing wires are stretched across long shutter beds before the concrete is extruded or slip formed along beds up to 130 m long. The prestress in the units induces a precamber. The overall camber of associated units should not normally exceed $L/300$. Some planks may need a concrete topping (not screed) to develop their full bending capacity or to contribute to diaphragm action. Minimum bearing lengths of 100 mm are required for masonry supports, while 75 mm is acceptable for supports on steelwork or concrete. Planks are normally 1200 mm wide at their underside and are butted up tight together on site. The units are only 1180 to 1190 mm wide at the top surface and the joints between the planks are grouted up on site. Narrower planks are normally available on special order in a few specific widths. Special details, notches, holes and fixings should be discussed with the plank manufacturer early in the design.

Typical spiroll hollowcore working load capacities

Nominal hollowcore plank depth mm	Fire resistance hours	Typical self-weight kN/m^2	Clear span for imposed loads*			
			1.5 m kN/m^2	3 m kN/m^2	5 m kN/m^2	10 m kN/m^2
150	up to 2	2.33	5.5–7.5	5.0–7.0	4.5–6.0	3.5–4.5
200	up to 2	2.94	7.5–10.0	7.0–8.5	6.0–7.5	4.5–6.0
260	2	3.97	10.0–12.0	8.5–11.0	7.5–10.0	6.0–8.0
320	2	3.97	12.0–14.5	11.0–13.0	10.0–11.5	8.0–9.5
400	2	4.83	14.5–17.5	13.0–15.5	11.5–14.0	9.5–11.5

*An allowance of 1.5 kN/m^2 for screeds and finishes has been included in addition to the plank self-weight.

Source: Tarmac Topfloor (2002). Note that this information is subject to change at any time. Consult the latest Tarmac literature for up to date information.

Bi-metallic corrosion

When two dissimilar metals are put together with an 'electrolyte' (normally water) an electrical current passes between them. The further apart the metals are on the galvanic series, the more pronounced this effect becomes.

The current consists of a flow of electrons from the anode (the metal higher in the galvanic series) to the cathode, resulting in the 'wearing away' of the anode. This effect is used to advantage in galvanizing where the zinc coating slowly erodes, sacrificially protecting the steelwork. Alloys of combined metals can produce mixed effects and should be chosen with care for wet or corrosive situations in combination with other metals.

The amount of corrosion is dictated by the relative contact surface (or areas) and the nature of the electrolyte. The effect is more pronounced in immersed and buried objects. The larger the cathode, the more aggressive the attack on the anode. Where the presence of electrolyte is limited, the effect on mild steel sections is minimal and for most practical building applications where moisture is controlled, no special precautions are needed. For greater risk areas where moisture will be present, gaskets, bushes, sleeves or paint systems can be used to separate the metal surfaces.

The galvanic series

Anode



Cathode

Magnesium
 Zinc
 Aluminium
 Carbon and low alloy steels (structural steel)
 Cast iron
 Lead
 Tin
 Copper, brass, bronze
 Nickel (passive)
 Titanium
 Stainless steels (passive)

Structural adhesives

There is little definite guidance on the use of adhesives in structural applications which can be considered if factory controlled conditions are available. Construction sites rarely have the quality control which is required. Adhesive manufacturers should be consulted to ensure that a suitable adhesive is selected and that it will have appropriate strength, durability, fire resistance, effect on speed of fabrication, creep, surface preparation, maintenance requirements, design life and cost. Data for specific products should be obtained from manufacturers.

Adhesive families

Epoxy resins	Good gap filling properties for wide joints, with good strength and durability; low cure shrinkage and creep tendency and good operating temperature range. The resins can be cold or hot cure, in liquid or in paste form but generally available as two part formulations. Relatively high cost limits their use to special applications.
Polyurethanes	Very versatile, but slightly weaker than epoxies. Good durability properties (resistance to water, oils and chemicals but generally not alkalis) with operating temperatures of up to 60°C. Moisture is generally required as a catalyst to curing, but moisture in the parent material can adversely affect the adhesive. Applications include timber and stone, but concrete should generally be avoided due to its alkalinity.
Acrylics	Toughened acrylics are typically used for structural applications which generally need little surface preparation of the parent material to enhance bond. They can exhibit significant creep, especially at higher operating temperatures and are best suited to tight fitting (thin) joints for metals and plastics.
Polyesters	Polyesters exhibit rapid strength gain (even in extremely low temperatures) and are often used for resin anchor fixings etc. However they can exhibit high cure shrinkage and creep, and have poor resistance to moisture.
Resorcinol-formaldehydes (RF) and phenol-resorcinol-formaldehydes (PRF)	Intended for use primarily with timber. Curing can be achieved at room temperature and above. These adhesives are expensive but strong, durable, water and boil proof and will withstand exposure to salt water. They can be used for internal and external applications, and are generally used in thin layers, e.g. finger joints in glulam beams.
Phenol-formaldehydes (PF)	Typically used in factory 'hot press' fabrication of structural plywood. Cold curing types use strong acids as catalysts which can cause staining of the wood. The adhesives have similar properties to RF and PRF adhesives.
Melamine-urea-formaldehydes (MUF) and urea-formaldehydes (UF)	Another adhesive typically used for timber, but these need protection from moisture. These are best used in thin joints (of less than 0.1 mm) and cure above 10°C.
Caesins	Derived from milk proteins, these adhesives are less water resistant than MUF and UF adhesives and are susceptible to fungal attack.
Polyvinyl acetates and elastomeric	Limited to non-loadbearing applications indoors as they have limited moisture resistance.
Adhesive tapes	Double sided adhesive tapes are typically contact adhesives and are suitable for bonding smooth surfaces where rapid assembly is required. The tapes have a good operating temperature range and can accommodate a significant amount of strain. Adhesive tapes are typically used for metals and/or glass in structural applications.

Surface preparation of selected materials in glued joints

Surface preparation is essential for the long-term performance of a glued joint and the following table describes the typical steps for different materials. Specific requirements should normally be obtained from the manufacturer of the adhesive.

Material	Surface preparation	Typical adhesive
Concrete	<ol style="list-style-type: none"> 1. Test parent material for integrity 2. Grit blast or water jet to remove the cement rich surface, curing agents and shutter oil, etc. 3. Vacuum dust and clean surface with solvent approved by the glue manufacturer 4. Apply a levelling layer to the roughened concrete surface before priming for the adhesive 	Epoxies are commonly used with concrete, while polyesters are used in resin fixings and anchors. Polyurethanes are not suitable for general use due to the alkalinity of the concrete
Steel and cast iron	<ol style="list-style-type: none"> 1. Degrease the surface 2. Mechanically wire brush, grit blast or water jet to remove millscale and surface coatings 3. Vacuum dust then prime surface before application of the adhesive 	Epoxies are the most common for use with structural iron/steel. Where high strength is not required acrylic or polyurethane may be appropriate, but only where humidity can be controlled or creep effects will not be problematic
Zinc coated steel	<ol style="list-style-type: none"> 1. Test the steel/zinc interface for integrity 2. Degrease the surface 3. Lightly abrade the surface and avoid rupturing the zinc surface 4. Vacuum dust and then apply an etch primer 5. Thoroughly clean off the etch primer and prime the surface for the adhesive 	Epoxies are suitable for structural applications. Acrylics are not generally compatible with the zinc surface
Stainless steel	<p>Factory method:</p> <ol style="list-style-type: none"> 1. Acid etch the surface and clean thoroughly 2. Apply primer <p>Site method:</p> <ol style="list-style-type: none"> 1. Degrease the surface with solvent 2. Grit blast 3. Apply chemical bonding agent, e.g. silane 	Toughened epoxies are normally used for structural applications
Aluminium	<p>Factory method:</p> <ol style="list-style-type: none"> 1. Degrease with solvent 2. Use alkaline cleaning solution 3. Acid etch, then neutralize 4. Prime surface before application of the adhesive <p>Site method (as 1 and 2):</p> <ol style="list-style-type: none"> 3. Grit blast 4. Apply a silane primer/bonding agent 	Epoxies and acrylics are most commonly used. Anodized components are very difficult to bond
Timber	<ol style="list-style-type: none"> 1. Remove damaged parent material 2. Dry off contact surfaces and ensure both surfaces have a similar moisture content (which is also less than 20) 3. Plane to create a clean flat surface or lightly abrade for sheet materials 4. Vacuum dust then apply adhesive promptly 	<p>Epoxies are normally limited to special repairs. RF and PRF adhesives have long been used with timber. Durability of the adhesive must be carefully considered. They are classified:</p> <p>WBP—Weather Proof and Boil Proof BR—Boil Resistant MR—Moisture Resistant INT—Interior</p>
Plastic and fibre composites	<ol style="list-style-type: none"> 1. Dust and degrease surface 2. Abrade surface to remove loose fibres and resin rich outer layers 3. Remove traces of solvent and dust 	Epoxies usual for normal applications. In dry conditions polyurethanes can be used, and acrylics if creep effects are not critical
Glass	<ol style="list-style-type: none"> 1. Degreasing should be the only surface treatment. Abrading or etching the surface will weaken the parent material 2. Silane primer is occasionally used 	Structural bonding tape or modified epoxies. The use of silicon sealant adhesives if curing times are not critical

Fixings and fastenings

Although there are a great number of fixings available, the engineer will generally specify nails, screws or bolts. Within these categories there are variations depending on the materials to be fixed. The fixings included here are standard gauges generally available in the UK.

Selected round wire nails to BS 1202

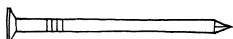

Length mm	Diameter (standard wire gauge (swg) and mm)						
	11 swg 3.0 mm	10 3.35	9 3.65	8 4.0	7 4.5	6 5.0	5 5.6
50	•	•					
75		•	•	•			
100			•	•	•	•	
125						•	
150							•

Selected wood screws to BS 1210

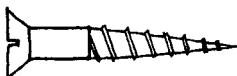

Length mm	Diameter (standard gauge (sg) and mm)						
	6 sg 3.48 mm	7 3.50	8 4.17	10 4.88	12 5.59	14 6.30	16 6.94
25	•	•	•	•	•		
50	•	•	•	•		•	•
75	•		•	•	•	•	•
100				•	•	•	•
125				•	•	•	•

Selected self-tapping screws to BS 4174

Self-tapping screws can be used in metal or plastics, while thread cutting screws are generally used in plastics or timber.

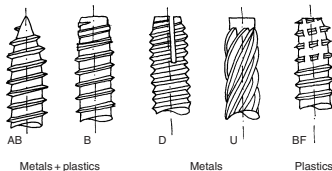

Selected ISO metric black bolts to BS 4190 and BS 3692

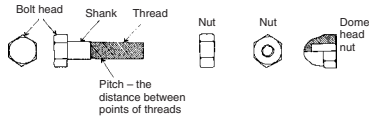

Nominal diameter mm	Coarse pitch mm	Maximum width of head and nut mm		Maximum height of head mm	Maximum thickness of nut (black) mm	Minimum distance between centres mm	Tensile stress area mm ²	Normal size* (Form E) round washers to BS 4320		
		Across flats	Across corners					Inside diameter mm	Outside diameter mm	Nominal thickness mm
M6	1.00	10	11.5	4.375	5.375	15	20.1	6.6	12.5	1.6
M8	1.25	13	15.0	5.875	6.875	20	36.6	9.0	17.0	1.6
M10	1.50	17	19.6	7.450	8.450	25	58.0	11.0	21.0	2.0
M12	1.75	19	21.9	8.450	10.450	30	84.3	14.0	24.0	2.5
M16	2.00	24	27.7	10.450	13.550	40	157.0	18.0	30.0	3.0
M20	2.50	30	34.5	13.900	16.550	50	245.0	22.0	37.0	3.0
M24	3.00	36	41.6	15.900	19.650	60	353.0	26.0	44.0	4.0
M30	3.50	46	53.1	20.050	24.850	75	561.0	33.0	56.0	4.0

* Larger diameter washers as Form F and Form G are also available to BS 4320.

Length* mm	Bolt size						
	M6	M8	M10	M12	M16	M20	M24
30	•	•					
50	•	•	•	•	•		
70		•	•	•	•	•	•
100			•	•	•	•	•
120			•	•	•	•	•
140				•	•	•	•
150				•	•	•	•
180				•	•	•	•

* Intermediate lengths are available.

M6, M8, M10 and M12 threaded bar (called studding) is also available in long lengths.

Spanner and podger dimensions

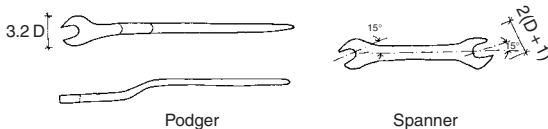

Podger

Spanner

Selected metric machine screws to BS 4183

Available in M3 to M20, machine screws have the same dimensions as black bolts but they are threaded full length and do not have a plain shank. Machine screws are often used in place of bolts and have a variety of screw heads:

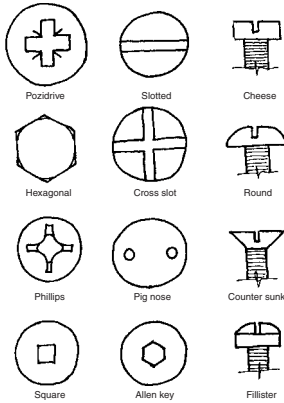

Selected coach screws to BS 1210

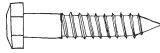

Typically used in timber construction. The square head allows the screw to be tightened by a spanner.

Length* mm	Diameter			
	6.25	7.93	9.52	12.5
25	•	•		
37.5	•		•	
50	•	•	•	
75	•	•	•	•
87.5	•	•		
100	•		•	•
112	•			
125		•	•	•
150		•	•	•
200				•

Selected welding symbols to BS 449

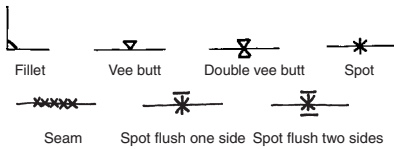

Cold weather working

Cold weather and frosts can badly affect wet trades such as masonry and concrete; however, rain and snow may also have an effect on ground conditions, make access to the site and scaffolds difficult, and cause newly excavated trenches to collapse. Site staff should monitor weather forecasts to plan ahead for cold weather.

Concreting

Frost and rain can damage newly laid concrete which will not set or hydrate in temperatures below 1°C. At lower temperatures, the water in the mixture will freeze, expand and cause the concrete to break up. Heavy rain can dilute the top surface of a concrete slab and can also cause it to crumble and break up.

- Concrete should not be poured below an air temperature of 2°C or if the temperature is due to fall in the next few hours. Local conditions, frost hollows or wind chill may reduce temperatures further.
- If work cannot be delayed, concrete should be delivered at a minimum temperature of 5°C and preferably at least 10°C, so that the concrete can be kept above 5°C during the pour.
- Concrete should not be poured in more than the lightest of rain or snow showers and poured concrete should be protected if rain or snow is forecast. Formwork should be left in place longer to allow for the slower gain in strength. Concrete which has achieved 5 N/mm² is generally considered frost safe.
- Mixers, handling plant, subgrade/shuttering, aggregates and materials should be free from frost and be heated if necessary. If materials and plant are to be heated, the mixing water should be heated to 60°C. The concrete should be poured quickly and in extreme cases, the shuttering and concrete can be insulated or heated.

Bricklaying

Frost can easily attack brickwork as it is usually exposed on both sides and has little bulk to retain heat. Mortar will not achieve the required strength in temperatures below 2°C. Work exposed to temperatures below 2°C should be taken down and rebuilt. If work must continue and a reduced mortar strength is acceptable, a mortar mix of 1 part cement to 5 to 6 parts sand with an air entraining agent can be used. Accelerators are not recommended and additives containing calcium chloride can hold moisture in the masonry resulting in corrosion of any metalwork in the construction.

- Bricks should not be laid at air temperatures below 2°C or if the temperature is due to fall in the next few hours. Bricklaying should not be carried out in winds of force 6 or above, and walls without adequate returns to prevent instability in high winds should be propped.
- Packs, working stacks and tops of working sections should be covered to avoid soaking, which might lead to efflorescence and/or frost attack. An airspace between any polythene and the brickwork will help to prevent condensation. Hessian and bubble wrap can be used to insulate. The protection should remain in place for about 7 days after the frost has passed. In heavy rain, scaffold boards nearest the brickwork can be turned back to avoid splashing, which is difficult to clean off.
- If bricks have not been dipped, a little extra water in the mortar mix will allow the bricks to absorb excess moisture from the mortar and reduce the risk of expansion of the mortar due to freezing.

Effect of fire on construction materials

This section is a brief summary of the effect of fire on structural materials to permit a quick assessment of how a fire may affect the overall strength and stability of a structure.

It is necessary to get an accurate history of the fire and an indication of the temperatures achieved. If this is not available via the fire brigade, clues must be gathered from the site on the basis of the amount of damage to the structure and finishes. At 150°C paint will be burnt away, at 240°C wood will ignite, at 400–500°C PVC cable coverings will be charred, zinc will melt and run off and aluminium will soften. At 600–800°C aluminium will run off and glass will soften and melt. At 900–1000°C most metals will be melting and above this, temperatures will be near the point where a metal fire might start.

The effect of heat on structure generally depends on the temperature, the rate and duration of heating, and the rate of cooling. Rapid cooling by dousing with water normally results in the cracking of most structural materials.

Reinforced concrete

Concrete is likely to blacken and spall, leaving the reinforcement exposed. The heat will reduce the compressive strength and elastic modulus of the section, resulting in cracking and creep/permanent deflections. For preliminary assessment, reinforced concrete heated to 100–300°C will have about 85% of its original strength, by 300–500°C it will have about 40% of its original strength and above 500°C it will have little strength left. As it is a poor conductor of heat only the outer 30–50 mm will have been exposed to the highest temperatures and therefore there will be temperature contours within the section which may indicate that any loss of strength reduces towards the centre of the section. At about 300°C concrete will tend to turn pink and at about 450–500°C it will tend to become a dirty yellow colour. Bond strengths can normally be assumed to be about 70% of pre-fire values.

Prestressed concrete

The concrete will be affected by fire as listed for reinforced concrete. More critical is the behaviour of the steel tendons, as non-recoverable extension of the tendons will result in loss of prestressing forces. For fires with temperatures of 350–400°C the tendons may have about half of their original capacity.

Timber

Timber browns at 120–150°C, blackens at 200–250°C and will ignite and char at temperatures about 400°C. Charring may not affect the whole section and there may be sufficient section left intact which can be used in calculations of residual strength. Charring can be removed by sandblasting or planing. Large timber sections have often been found to perform better in fire than similarly sized steel or concrete sections.

Brickwork

Bricks are manufactured at temperatures above 1000°C, therefore they are only likely to be superficially or aesthetically damaged by fire. It is the mortar which can lose its strength as a result of high temperatures. Cementitious mortar will react very similarly to reinforced concrete, except without the reinforcement and section mass, it is more likely to be badly affected. Hollow blocks tend to suffer from internal cracking and separation of internal webs from the main block faces.

Steelwork

The yield strength of steel at 20°C is reduced by about 50% at 550°C and at 1000°C it is 10% or less of its original value. Being a good conductor of heat, the steel will reach the same temperature as the fire surrounding it and transfer the heat away from the area to affect other remote areas of the structure. Steelwork heated up to about 600°C can generally be reused if its hardness is checked. Cold worked steel members are more affected by increased temperature. Connections should be checked for thread stripping and general soundness. An approximate guide is that connections heated to 450°C will retain full strength, to 600°C will retain about 80% of their strength and to 800°C will retain only about 60% of their strength.

Aluminium

Aluminium is extracted from ore and has little engineering use in its pure form. Aluminium is normally alloyed with copper, magnesium, silicon, manganese, zinc, nickel and chromium to dramatically improve its strength and work hardening properties.

Aluminium has a stiffness of about one third of that for steel and therefore it is much more likely to buckle in compression than steel. The main advantage of aluminium is its high strength:weight ratio, particularly in long span roof structures. The strength of cold worked aluminium is reduced by the application of heat, and therefore jointing by bolts and rivets is preferable to welding.

For structural purposes wrought aluminium alloy sections are commonly used. These are shaped by mechanical working such as rolling, forging, drawing and extrusion. Heat treatments are also used to improve the mechanical properties of the material. This involves the heating of the alloy followed by rapid cooling, which begins a process of ageing resulting in hardening of the material over a period of a few days following the treatment. The hardening results in increased strength without significant loss of ductility. Wrought alloys can be split into non-heat treatable and heat treatable according to the amount of heat treatment and working received. The temper condition is a further classification, which indicates the processes which the alloy has undergone to improve its properties. Castings are formed from a slightly different family of aluminium alloys.

Summary of material properties

Density	27.1 kN/m ³
Poisson's ratio	0.32
Modulus of elasticity, <i>E</i>	70 kN/mm ²
Modulus of rigidity, <i>G</i>	23 kN/mm ²
Linear coefficient of thermal expansion	$24 \times 10^{-6} / ^\circ\text{C}$

Notation for the classification of structural alloys

Heat treatable alloys	T4	Heat treated – naturally aged
	T6	Heat treated – artificially aged
Non-heat treatable alloys	F	Fabricated
	O	Annealed
	H	Strain hardened

Summary of main structural aluminium alloys to BS 8118

Values of limiting stresses depend on whether the products are extrusions, sheet, plate or drawn tubes.

Alloy	Temper	Types of product*	Typical thicknesses mm	Durability	Approx. loss of strength due to welding (%)	Limiting stresses			
						P_y N/mm ²	P_c/P_t N/mm ²	P_v N/mm ²	
Heat treatable	6063	T4	Thin walled extruded sections and tubes as used in curtain walling and window frames	1–150	B	0	65	85	40
		T6		1–150		50	160	175	95
	6082	T4	Solid and hollow extrusions	1–150	B	0	115	145	70
T6		1–20		50		255	275	155	
		20–150		50		270	290	160	
Non-heat treatable	5083	O	Sheet and plate. Readily welded. Often used for plating and tanks	0.2–80	A	0	105	150	65
		F		3–25		0	130	170	75
		H22		0.2–6		45	235	270	140
	LM 5	F	Mainly sand castings in simple shapes with high surface polish	–	A	–	Strengths of castings determined in consultation with castings manufacturer. Approx. values:		
	LM 6	F	Good for complex shaped castings Sand castings Chill castings	–	B	–	40–120	70–140	25–75

*British Aluminium Extrusions do a range of sections in heat treatable aluminium alloys.

Source: BS 8118: Part 1: 1997

Durability

Corrosion protection guidelines are set out in BS 8118: Part 2. Each type of alloy is graded as A or B. Corrosion protection is only required for A rated alloys in severe industrial, urban or marine areas. Protection is required for B rated alloys for all applications where the material thickness is less than 3 mm, otherwise protection is only required in severe industrial, urban or marine areas and where the material is immersed in fresh or salt water.

Substances corrosive to aluminium include: timber preservatives; copper naphthanate, copper-chrome-arsenic or borax-boric acid; oak, chestnut and western red cedar unless they are well seasoned; certain cleaning agents and building insulation. Barrier sealants (e.g. bituminous paint) are therefore often used.

Fire protection

Aluminium conducts heat four times as well as steel. Although this conductivity means that 'hot spots' are avoided, aluminium has a maximum working temperature of about 200 to 250°C (400°C for steel) and a melting temperature of about 600°C (1200°C for steel). In theory fire protection could be achieved by using thicker coatings than those provided for steel, aluminium is generally used in situations where fire protection is not required. Possible fire protection systems might use ceramic fibre, intumescent paints or sacrificial aluminium coatings.

Selected sizes of extruded aluminium sections to BS 1161

Section type	Range of sizes (mm)	
	Minimum	Maximum
Equal angles	30 × 30 × 2.5	120 × 120 × 10
Unequal angles	50 × 38 (web 3, flange 4)	140 × 105 (web 8.5, flange 11)
Channels	60 × 30 (web 5, flange 6)	240 × 100 (web 9, flange 13)
I sections	60 × 30 (web 4, flange 6)	160 × 80 (web 7, flange 11)
Tee sections	50 × 38 × 3	120 × 90 × 10

Rolled plates in thicknesses of 6.5–155 mm can be obtained in widths up to 3 m and lengths up to 15 m.

Structural design to BS 8118: Part 1

Partial safety factors for applied loads

BS 8118 operates a two tier partial safety factor system. Each load is first factored according to the type of load and when loads are combined, their total is factored according to the load combination. Dynamic effects are considered as imposed loads and must be assessed to control vibration and fatigue. This is not covered in detail in BS 8118 which suggests 'special' modelling.

Primary load factors

Load type	γ_{f1}
Dead	1.20 or 0.80
Imposed	1.33
Wind	1.20
Temperature effects	1.00

Secondary load factors for load combinations

Load combinations	γ_{f2}
Dead load	1.0
Imposed or wind load giving the most severe loading action on the component	1.0
Imposed or wind load giving the second most severe loading action on the component	0.8
Imposed or wind load giving the third most severe loading action on the component	0.6
Imposed or wind load giving the fourth most severe loading action on the component	0.4

Partial safety factors for materials depending on method of jointing

Type of construction	γ_m	
	Members	Joints
Riveted and bolted	1.2	1.2
Welded	1.2	1.3 or 1.6
Bonded/glued	1.2	3.0

Comment on aluminium design to BS 8118

As with BS 5950 for steel, the design of the structural elements depends on the classification of the cross section of the element. An initial estimate of bending strength would be $M_b = p_y S / \gamma_m$ but detailed reference must be given to the design method in the code. Strength is usually limited by local or overall buckling of the section and deflections often govern the design.

Source: BS 8118: Part 1: 1997.

13

Useful Mathematics

Trigonometric relationships

Addition formulae

$$\sin(A \pm B) = \sin A \cos B \pm \cos A \sin B$$

$$\cos(A \pm B) = \cos A \cos B \mp \sin A \sin B$$

$$\tan(A \pm B) = \frac{\tan A \pm \tan B}{1 \mp \tan A \tan B}$$

Sum and difference formulae

$$\sin A + \sin B = 2 \sin \frac{1}{2}(A + B) \cos \frac{1}{2}(A - B)$$

$$\sin A - \sin B = 2 \cos \frac{1}{2}(A + B) \sin \frac{1}{2}(A - B)$$

$$\cos A + \cos B = 2 \cos \frac{1}{2}(A + B) \cos \frac{1}{2}(A - B)$$

$$\cos A - \cos B = -2 \sin \frac{1}{2}(A + B) \sin \frac{1}{2}(A - B)$$

$$\tan A + \tan B = \frac{\sin(A + B)}{\cos A \cos B}$$

$$\tan A - \tan B = \frac{\sin(A - B)}{\cos A \cos B}$$

Product formulae

$$2 \sin A \cos B = \sin(A - B) + \sin(A + B)$$

$$2 \sin A \sin B = \cos(A - B) - \cos(A + B)$$

$$2 \cos A \cos B = \cos(A - B) + \cos(A + B)$$

Multiple angle and powers formulae

$$\sin 2A = 2 \sin A \cos A$$

$$\cos 2A = \cos^2 A - \sin^2 A$$

$$\cos 2A = 2 \cos^2 A - 1$$

$$\cos 2A = 1 - 2 \sin^2 A$$

$$\tan 2A = \frac{2 \tan A}{1 - \tan^2 A}$$

$$\sin^2 A + \cos^2 A = 1$$

$$\sec^2 A = \tan^2 A + 1$$

Relationships for plane triangles

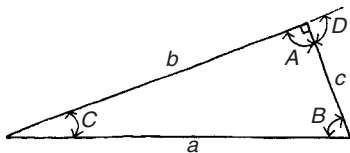

Pythagoras for right angled triangles:

$$a^2 + b^2 = c^2$$

Sin rule:

$$\frac{a}{\sin A} = \frac{b}{\sin B} = \frac{c}{\sin C}$$

$$\sin A = \frac{2}{bc} \sqrt{s(s-a)(s-b)(s-c)},$$

where $s = (a + b + c)/2$

Cosine rule:

$$a^2 = b^2 + c^2 - 2bc \cos A$$

$$a^2 = b^2 + c^2 + 2bc \cos D$$

$$\cos A = \frac{b^2 + c^2 - a^2}{2bc}$$

Special triangles

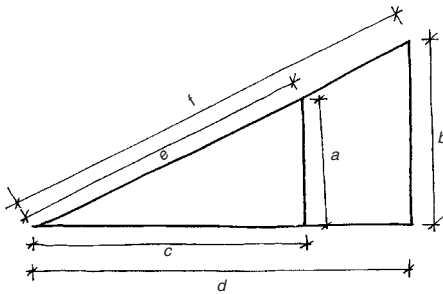
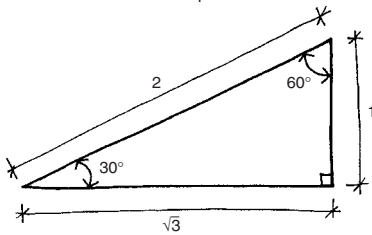
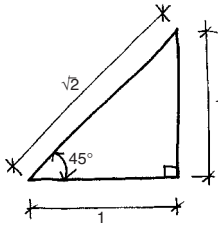
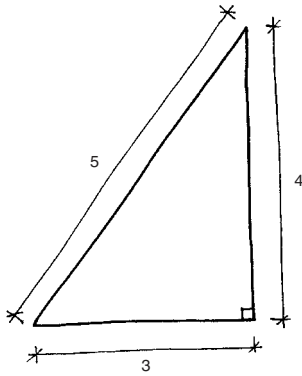

$$\frac{a}{b} = \frac{c}{d} = \frac{e}{l}$$

Algebraic relationships

Quadratics

$$ax^2 + bx + c = 0$$

$$x = \frac{-b \pm \sqrt{b^2 - 4ac}}{2a}$$

$$x^2 + 2xy + y^2 = (x + y)^2$$

$$x^2 - y^2 = (x + y)(x - y)$$

$$x^3 - y^3 = (x - y)(x^2 + xy + y^2)$$

Powers

$$a^x - a^y = a^{x+y}$$

$$\frac{a^x}{a^y} = a^{x-y}$$

$$(a^x)^y = a^{xy}$$

Logarithms

$$x \equiv e^{\log_e x} \equiv e^{\ln x}$$

$$x \equiv \log_{10}(10^x) \equiv \log_{10}(\text{antilog}_{10} x) \equiv 10^{\log_{10} x}$$

$$e = 2.71828$$

$$\ln x = \frac{\log_{10} x}{\log_{10} e} = 2.30259 \log_{10} x$$

Equations of curves

Circle

$$x^2 + y^2 = a^2$$

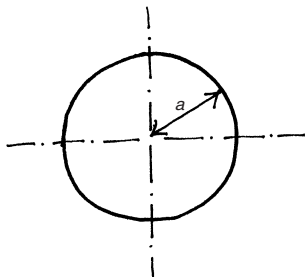

Ellipse

$$\frac{x^2}{a^2} + \frac{y^2}{b^2} = 1$$

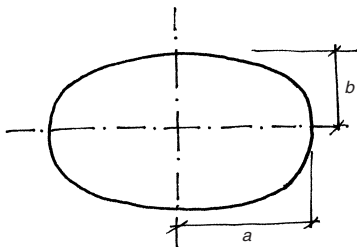

Hyperbola

$$\frac{x^2}{a^2} - \frac{y^2}{b^2} = 1$$

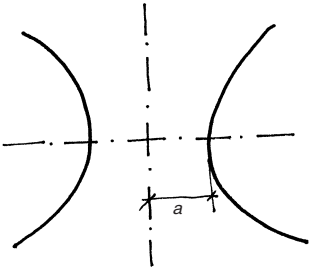

Parabola

$$y^2 = ax$$

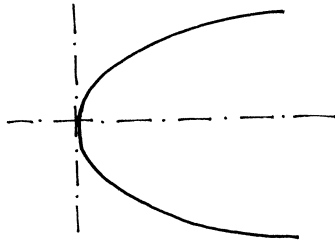

Circular arc

$$R = \left(d^2 + \frac{L^2}{4} \right) \frac{1}{2d}$$

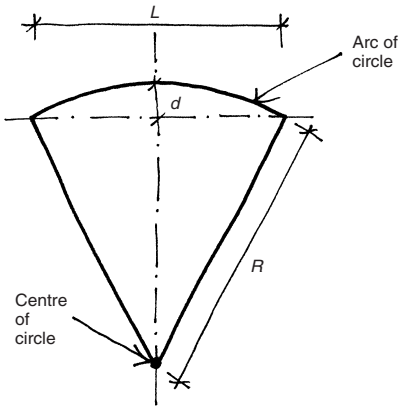

Rules for differentiation and integration

$$\frac{d}{dx}(uv) = u \frac{dv}{dx} + v \frac{du}{dx}$$

$$\frac{d}{dx}\left(\frac{u}{v}\right) = \frac{1}{v^2}\left(v \frac{du}{dx} - u \frac{dv}{dx}\right)$$

$$\frac{d}{dx}(uvw) = uv \frac{dw}{dx} + uw \frac{dv}{dx} + vw \frac{du}{dx}$$

$$\int (uv)dx = u \int (v)dx - \int \frac{du}{dx} \int (v)dx$$

Standard differentials and integrals

$$\frac{d}{dx}x^n = nx^{n-1}$$

$$\int x^n dx = \frac{x^{n+1}}{n+1} \quad n \neq -1$$

$$\frac{d}{dx} \ln x = \frac{1}{x}$$

$$\int \frac{1}{x} dx = \ln x$$

$$\frac{d}{dx} e^{ax} = ae^{ax}$$

$$\int e^{ax} dx = \frac{e^{ax}}{a} \quad a \neq 0$$

$$\frac{d}{dx} a^x = a^x \ln a$$

$$\int a^x dx = \frac{a^x}{\ln a} \quad a > 0, a \neq 1$$

$$\frac{d}{dx} x^x = x^x(1 + \ln x)$$

$$\int \ln x dx = x(\ln x - 1)$$

$$\frac{d}{dx} \sin x = \cos x$$

$$\int \sin x dx = -\cos x$$

$$\frac{d}{dx} \cos x = -\sin x$$

$$\int \cos x dx = \sin x$$

$$\frac{d}{dx} \tan x = \sec^2 x$$

$$\int \tan x dx = -\ln(\cos x)$$

$$\frac{d}{dx} \cot x = -\operatorname{cosec}^2 x$$

$$\int \cot x dx = \ln(\sin x)$$

$$\frac{d}{dx} \sin^{-1} x = \frac{1}{\sqrt{1-x^2}}$$

$$\int \sec^2 x dx = \tan x$$

$$\frac{d}{dx} \cos^{-1} x = \frac{-1}{\sqrt{1-x^2}}$$

$$\int \operatorname{cosec}^2 x dx = -\cot x$$

$$\frac{d}{dx} \tan^{-1} x = \frac{1}{1+x^2}$$

$$\int \frac{1}{\sqrt{1-x^2}} dx = \sin^{-1} x \quad |x| < 1$$

$$\frac{d}{dx} \cot^{-1} x = \frac{-1}{1+x^2}$$

$$\int \frac{1}{1+x^2} dx = \tan^{-1} x$$

Useful Addresses

Advisory organizations

Aluminium Federation Ltd

Broadway House, Calthorpe Road, Five Ways,
Birmingham B15 1TN
www.alfed.org.uk

tel: 0121 456 1103
fax: 0870 137 8443

Ancient Monuments Society

St Anne's Vestry Hall, 2 Church Entry, London
EC4V 5HB
www.ancientmonumentsociety.org.uk

tel: 020 7236 3934
fax: 020 7329 3677

Arboricultural Association

Ampfield House, Ampfield, Romsey, Hampshire
SO51 9PA
www.trees.org.uk

tel: 01794 368717
fax: 01794 368978

Architects Registration Board (ARB)

73 Hallam Street, London W1N 6EE
www.arb.org.uk

tel: 020 7580 5861
fax: 020 7436 5269

Asbestos Removal Contractors Association (ARCA)

Arca House, 237 Branston Road, Burton-upon-
Trent, Staffordshire DE1 3BT
www.arca.org.uk

tel: 01283 531126
fax: 01283 568228

Association for the Conservation of Energy

Westgate House, Prebend Street, London N1 8PT
www.ukace.org

tel: 020 7359 8000
fax: 020 7359 0863

Association of Consulting Engineers

Alliance House, 12 Caxton Street, London SW1 OQL
www.acenet.co.uk

tel: 020 7222 6557
fax: 020 7222 0750

Association of Planning Supervisors (APS)

16 Rutland Square, Edinburgh EH1 2BE
www.aps.org.uk

tel: 0131 221 9959
fax: 0131 221 0061

Brick Development Association Ltd (BDA)

Woodwide House, Winkfield, Windsor, Berkshire
SL4 2DX
www.brick.org.uk

tel: 01344 885651
fax: 01344 896129

British Adhesives & Sealants Association (BASA)

33 Fellowes Way, Stevenage, Hertfordshire SG2 8BW tel: 01438 358514
 www.basa.uk.com fax: 01438 742565

British Architectural Library

RIBA, 66 Portland Place, London W1N 4AD tel: 020 7580 5533
 www.riba-library.com fax: 020 7631 1802

British Board of Agrément (BBA)

PO Box 195, Bucknalls Lane, Garston, Watford, Herts WD2 7NG tel: 01923 665300
 www.bbacerts.co.uk fax: 01923 665301

British Cement Association (BCA)

Century House, Telford Avenue, Crowthorne, Berks RG45 6YS tel: 01344 762676
 www.bca.org.uk fax: 01344 761214

British Constructional Steelwork Association Ltd (BCSA)

4 Whitehall Court, London SW1A 2ES tel: 020 7839 8566
 www.steelconstruction.org fax: 020 7976 1634

British Library

96 Euston Road, London NW1 2DB tel: 020 7412 7676
 www.bl.uk fax: 020 7412 7954

British Non-Ferrous Metals Federation (BNFMF)

10 Greenfield Crescent, Edgbaston, Birmingham B15 3AU tel: 0121 456 3322
 fax: 0121 456 1394

British Precast Concrete Federation (BPCF)

60 Charles Street, Leicester LE1 1FB tel: 0116 253 6161
 www.britishprecast.org fax: 0116 251 4568

British Rubber Manufacturers' Association Ltd (BRMA)

6 Bath Place, Rivington Street, London EC2A 3JE tel: 020 7457 5040
 www.brma.co.uk fax: 020 7972 9008

British Safety Council (BSC)

70 Chancellor's Road, London W6 9RS tel: 020 8741 1231
 www.britishsafetycouncil.org fax: 020 8741 4555

British Stainless Steel Association

Light Trades House, 3 Melbourne Avenue, Sheffield S10 2QJ tel: 0114 290 0888
 www.bssa.org.uk fax: 0114 290 0897

British Standards Institution (BSI)

389 Chiswick High Road, London W4 4AL tel: 020 8996 9001
 www.bsi-global.com fax: 020 8996 7001

British Stone

Kent House, 77 Compton Road, Wolverhampton WV3 9QH tel: 01902 717789
 www.british-stone.com fax: 01902 717789

British Waterways Board

Willow Grange, Watford WD1 3QA
www.britishwaterways.com

tel: 01923 226422
 fax: 01923 226081

British Wood Preserving & Damp Proofing Association (BWPDA)

1 Gleneagles House, Vernon Gate, Derby DE1 1UP
www.bwpda.co.uk

tel: 01332 225100
 fax: 01332 225101

Building Centre

26 Store Street, London WC1E 7BZ
www.buildingcentre.co.uk

tel: 020 7692 4000
 fax: 020 7580 9641

Building Research Advisory Service

Bucknalls Lane, Garston, Watford WD2 7JR
www.bre.co.uk

tel: 01923 664664
 fax: 01923 664098

Building Research Establishment (BRE)

Bucknalls Lane, Garston, Watford WD2 7JR
www.bre.co.uk

tel: 01923 664000
 fax: 01923 664787

Building Services Research and Information Association (BSRIA)

Old Bracknell Lane West, Bracknell, Berks RG12 7AH
www.bsria.co.uk

tel: 01344 426511
 fax: 01344 487575

CADW – Welsh Historic Monuments

Crown Buildings, Cathays Park, Cardiff CF10 3NQ
www.cadw.wales.gov.uk

tel: 029 2050 0200
 fax: 029 2082 6375

Cares (UK Certification Authority for Reinforcing Steels)

Pembroke House, 21 Pembroke Road, Sevenoaks, Kent TN13 1XR
www.ukcares.com

tel: 01732 450000
 fax: 01732 455917

Cast Metal Federation

47 Birmingham Road, West Bromwich Road, West Bromwich B70 6PY
www.castmetalfederation.com

tel: 0121 601 6390
 fax: 0121 601 6391

Castings Development Centre

Alvechurch, Birmingham B48 7QB

tel: 01527 66414
 fax: 01527 585070

Commission for Architecture and the Built Environment (CABE)

The Tower Buildings, 11 York Road, London SE1 7NX
www.cabe.org.uk

tel: 020 7960 2400
 fax: 020 7960 2444

Concrete Repair Association (CRA)

Association House, 235 Ash Road, Aldershot, Hampshire GU12 4DD
www.concreterepair.org.uk

tel: 01252 321302
 fax: 01252 333901

Concrete Society

Century House, Telford Avenue, Crowthorne, Berks RG45 6YS
www.concrete.org.uk

tel: 01344 466007
 fax: 01344 466008

Construction Fixings Association

Light Trades House, Melbourne Avenue, Sheffield
S10 2QJ
www.britishtools.com

tel: 0114 266 3084
fax: 0114 267 0910

Construction Industry Research & Information Association (CIRIA)

6 Storey's Gate, London SW1P 3AU
www.ciria.org.uk

tel: 020 7222 8891
fax: 020 7222 1708

Copper Development Association (CDA)

Verulam Industrial Estate, 224 London Road,
St Albans, Herts AL1 1AQ
www.cda.org.uk

tel: 01727 731200
fax: 01727 731216

CORUS Construction Centre

PO Box 1, Scunthorpe, North Lincolnshire DN16 1BP
www.corusconstruction.com

tel: 01724 405060
fax: 01724 404224

Council for Aluminium in Building

191 Cirencester Road, Charlton Kings,
Cheltenham, Glos GL53 8DF
www.c-a-b.org.uk

tel: 01242 578278
fax: 01242 578283

Design Council

34 Bow Street, London WC2E 7DL
www.designcouncil.org.uk

tel: 020 7420 5200
fax: 020 7420 5300

English Heritage

23 Saville Row, London W1X 1AB
www.english-heritage.org.uk

tel: 020 7973 3000
fax: 020 7973 3001

Environment & Heritage Service (EHS) – Northern Ireland

Clarence House, 10–18 Adelaide Street, Belfast
BT2 8GB
www.ehsni.gov.uk

tel: 028 9054 3034

Environment Agency

Rio House, Waterside Drive, Aztec Way,
Almondsbury, Bristol BS12 4UD
www.environment-agency.gov.uk

tel: 01454 624400
fax: 01454 878615

European Glaziers Association (UEMV)

PO Box 416, NL 1800 Ak Alkmaar, Netherlands
www.uemv.com

tel: +31 725114161
fax: +31 725113783

**European Stainless Steel Advisory Body
(Euro-Inox)**

241 Route d'Alon, L-1150 Luxembourg
www.euro-inox.org

tel: +352 26 10 30 50
fax: +352 26 10 30 51

Federation of Manufacturers of Construction Equipment & Cranes

Ambassador House, Bristock Road, Thornton
Heath, Surrey CR7 7JGG
www.coneq.org.uk

tel: 020 8665 5727
fax: 020 8665 6447

Federation of Master Builders

FMB Headquarters, 14/15 Great James Street,
London WC1N 3DP
www.fmb.org.uk

tel: 020 7242 7583
fax: 020 7404 0296

Federation of Piling Specialists

Forum Court, 83 Copers Cope Road, Beckenham,
Kent BR3 1NR
www.fps.org.uk

tel: 020 8663 0947
fax: 020 8663 0949

Fire Protection Association (FPA)

Bastille Court, 2 Paris Garden, London SE1 8ND
www.thefpa.co.uk

tel: 020 7902 5300
fax: 020 7902 5301

Friends of the Earth

26–28 Underwood Street, London N1 7JQ
www.foe.co.uk

tel: 020 7490 1555
fax: 020 7490 0881

Galvanizers' Association

Wren's Court, 56 Victoria Road, Sutton Coldfield,
W. Midlands B72 1SY
www.hdg.org.uk

tel: 0121 355 8838
fax: 0121 355 8727

Georgian Group

6 Fitzroy Square, London W1P 6DX
www.georgiangroup.org.uk

tel: 020 7387 1720
fax: 020 7387 1721

Glass and Glazing Federation

44 Borough High Street, London SE1 1XB
www.ggf.org.uk

tel: 020 7403 7177
fax: 020 7357 7458

Glue Laminated Timber Association

Chiltern House, Stocking Lane, High Wycombe
HP14 4ND
www.glulam.co.uk

tel: 01494 565180
fax: 01494 565487

Health and Safety Executive (HSE)

Rose Court, 2 Southwark Bridge, London SE1 9HS
www.hse.gov.uk

tel: 020 7717 6000
fax: 020 7717 6717

Historic Scotland

Longmore House, Salisbury Place, Edinburgh EH9
1SH
www.historic-scotland.gov.uk

tel: 0131 668 8707
fax: 0131 668 8669

HM Land Registry

Lincoln's Inn Fields, London WC2A 3PH
www.landreg.gov.uk

tel: 020 7917 8888
fax: 020 7955 0110

Institute of Building Control (IBC)

92–104 East Street, Epsom, Surrey KT17 1EB
www.demon.co.uk/instobc

tel: 01372 745577
fax: 01372 748282

Institution of Civil Engineers (ICE)

1–7 Great George Street, London SW1P 3AA
www.ice.org.uk

tel: 020 7222 7722
fax: 020 7222 7500

Institution of Structural Engineers (IStructE)

11 Upper Belgrave Street, London SW1X 8BH
www.istructe.org.uk

tel: 020 7235 4535
fax: 020 7201 9157

London Metropolitan Archives

40 Northampton Road, London EC1 0HB
www.cityoflondon.gov.uk

tel: 020 7332 3820
fax: 020 7833 9136

Meteorological Office

London Road, Bracknell, Berks RG12 2SZ
www.meto.gov.uk

tel: 01344 420242
fax: 01344 854943

National Building Specification Ltd (NBS)

Mansion House Chambers, The Close, Newcastle upon Tyne NE1 3RE
www.nbservices.co.uk

tel: 0191 232 9594
fax: 0191 232 5714

National Federation of Demolition Contractors (NFDC)

1A New Road, The Causeway, Staines, Middlesex TW18 3DH
www.demolition-nfdc.com

tel: 01784 456799
fax: 01784 461118

National Glass Reinforced Plastics Association

Construction House, 56–64 Leonard Street, London EC2A 4JX

tel: 020 7608 5099
fax: 020 7608 5081

National House-Building Council (NHBC)

Builmark House, Chiltern Avenue, Amersham, Bucks HP6 5AP
www.nhbc.co.uk

tel: 01494 434477
fax: 01494 728521

Nickel Development Institute (NIDI)

The Holloway, Alvechurch, Birmingham N48 7QB
www.nidi.org

tel: 01527 584 777
fax: 01527 585 562

Ordnance Survey

Romsey Road, Southampton SO9 4DH
www.ordnancesurvey.co.uk

tel: 023 8079 2000
fax: 023 8079 2452

Paint and Powder Finishing Association

Federation House, 10 Vyse Street, Birmingham B18 6LT
www.ppfa.org.uk

tel: 0121 237 1123
fax: 0121 237 1124

Paint Research Association (PRA)

8 Waldegrave Road, Teddington, Middx TW11 8LD
www.pra.org.uk

tel: 020 8614 4800
fax: 020 8943 4075

Plastics and Rubber Advisory Service, British Plastics Federation (BPF)

6 Bath Place, Rivington Street, London EC2A 3JE
www.bpf.co.uk

tel: 020 7457 5000
fax: 020 7457 5045

Pyramus and Thisbe Club

Administration Office, Rathdale Road, Rathfriland, Belfast BT34 5QF
www.partywalls.org.uk

tel: 028 4063 2082
fax: 028 4063 2083

Quarry Products Association

156 Buckingham Palace Road, London SW1W
9TR
www.qpa.org

tel: 020 7730 8194
fax: 020 7730 4355

Railtrack plc/Network Rail

Railtrack House, Euston Square, London NW1
2EX
www.freightcommercial.co.uk/
www.networkrail.com

tel: 020 7557 8000
fax: 020 7557 9000

Ready Mixed Concrete Bureau

Century House, Telford Avenue, Crowthorne,
Berkshire RG45 6YS
www.rcb.org.uk

tel: 01344 725732
fax: 01344 774976

Royal Incorporation of Architects in Scotland (RIAS)

15 Rutland Square, Edinburgh EH1 2BE
www.rias.org.uk

tel: 0131 229 7545
fax: 0131 228 2188

Royal Institute of British Architects (RIBA)

66 Portland Place, London W1B 1AD
www.architecture.com

tel: 020 7580 5533
fax: 020 7255 1541

Royal Institution of Chartered Surveyors (RICS)

12 Great George Street, London SW1P 3AD
www.rics.org.uk

tel: 020 7222 7000
fax: 020 7334 3800

Royal Society of Architects in Wales

Bute Building, King Edward VII Avenue, Cathays
Park, Cardiff CF1 3NB
www.architecture.com

tel: 029 2087 4753
fax: 029 2087 4926

Royal Society of Ulster Architects (RSUA)

2 Mount Charles, Belfast BT7 1NZ
www.rsua.org.uk

tel: 028 9032 3760
fax: 028 9023 7313

Society for the Protection of Ancient Buildings

37 Spital Square, London E1 6DY
www.spab.org.uk

tel: 020 7377 1644
fax: 020 7247 5296

Stainless Steel Advisory Service

Rm 2.04 The Innovation Centre, 217 Portobello,
Sheffield S1 4DP
www.bssa.org.uk

tel: 0114 224 2240
fax: 0114 273 0444

Stationery Office (previously HMSO)

PO Box 29, Norwich NR3 1GN
www.itsofficial.net

tel: 0870 600 5522
fax: 0870 600 5533

Steel Construction Institute (SCI)

Silwood Park, Buckhurst Road, Ascot, Berks SL5
7QN
www.steel-sci.org.uk

tel: 01344 623345
fax: 01344 622944

Stone Federation Great Britain (SFGB)

Construction House, 56–64 Leonard Street,
London EC2A 4JX
www.stone-federationgb.org.uk

tel: 020 7608 5080
fax: 020 7608 5081

Thermal Spraying & Surface Engineering Association

18 Hammerton Way, Wellesbourne,
Warwickshire CV35 9NT

tel: 01789 842 822
fax: 01789 842 229

Timber Trade Federation

26 Oxendon Street, London SW1Y 4EL
www.ttf.co.uk

tel: 020 7839 1891
fax: 020 7930 0094

TRADA Technology Ltd

Stocking Lane, Hughenden Valley, High
Wycombe HP14 4ND
www.tradatechnology.co.uk

tel: 01494 563091
fax: 01494 565487

UK Cast Stone Association

15 Stonehill Court, The Arbours, Northampton
NN3 3RA
www.ukcsa.co.uk

tel: 01604 405666
fax: 01604 405666

Victorian Society

1 Priory Gardens, Bedford Park, London W4 1TT
www.victorian-society.org.uk

tel: 020 8994 1019
fax: 020 8995 4895

Water Authorities Association

1 Queen Anne's Gate, London, SW1H 9BT
www.water.org.uk

tel: 020 7344 1844
fax: 020 7344 1866

Water Jetting Association

17 Judiths Lane, Sawtrey, Huntingdon,
Cambridgeshire PE28 5XE
www.waterjetting.org.uk

tel: 01487 834034
fax: 01487 832232

Wood Panel Industries Federation

28 Market Place, Grantham, Lincolnshire NG31
6LR

tel: 01476 563707
fax: 01476 579314

Manufacturers

3M Tapes & Adhesives UK Ltd

3M House, 28 Great Jackson Street, Manchester
M15 4PA
www.mmm.com/uk

tel: 0161 236 8500
fax: 0161 237 1105

Angle Ring Company Ltd

Bloomfield Road, Tipton, West Midlands DY4 9EH
www.anglering.co.uk

tel: 0121 557 7241
fax: 0121 522 4555

Aplant Acrow/Ashtead Group plc

Kings Court, 41–51 Kingston Road, Leatherhead,
Surrey KT22 7SZ
www.aplant.com

tel: 0800 614169

BGT Bischoff Glastechnik

Alexanderstraße 2, 705015 Bretten, Germany
www.bgt-bretten.de

tel: +49 7252 5030
fax: +49 7252 503283

BRC Building Products

Carver Road, Astonfields Industrial Estate,
Stafford ST16 3BP
www.brc-buildingproducts.co.uk

tel: 01785 222288
fax: 01785 240029

British Aluminium Extrusions

Southam Road, Banbury, Oxfordshire OX16 7SN

tel: 01295 454545
fax: 01295 454690

Caltite/Cementaid (UK) Ltd

2 Rutherford Way Industrial Estate, Crawley, West
Sussex RH10 2PB
www.cementaid.com

tel: 01293 447878
fax: 01293 447880

Catnic

Corus UK Ltd, Pontyglyndy Industrial Estate,
Caerphilly CF83 2WJ
www.catnic.com

tel: 029 2033 7900
fax: 029 2086 3178

CORUS Group

Welson Road, Corby NN17 5UA
www.corusgroup.com/
www.corusconstruction.com

tel: 01536 402121
fax: 01536 404111

Cricursa

Poligono Industrial, Coll de la Manya, 08400
Ganhollers, Barcelona, Spain
www.cricursa.com

tel: +34 93 840 4470

Dow Corning Ltd

Meriden Business Park, Copse Drive, Allesley,
Coventry CV5 9RG
www.dowcorning.com

tel: 01676 528000
fax: 01676 528001

Eckelt

Zentrale/Produktion, Resthofstraße 18, 4400 Steyr,
Austria
www.eckelt.at

tel: +43 72528940
fax: +43 725289424

European Glass Ltd

6, 8 and 10 Cumberland Avenue, Park Royal,
London NW10 7RT

tel: 020 8961 6066
fax: 020 8961 1411

FA Firman (Harold Wood) Ltd

19 Bates Road, Harold Wood, Romford, Essex
RM3 0JH
www.firmanglass.co.uk

tel: 01708 374534
fax: 01708 340511

Finnforest

5 Sundial Court, Tolworth Rise South, Surbiton,
Surrey KT5 9NN
www.finnforest.com

tel: 020 8901 3400
fax: 020 8422 9369

Hansen Brick Ltd

Stewartby, Bedfordshire MK43 9LZ
www.hansen-brickeurope.com

tel: 0870 5258258
fax: 01234 762040

Hansen Glass

Greengate Industrial Park, Middleton, Manchester
M24 1SW
www.hansengroup.biz

tel: 0161 653 3030
fax: 0161 653 3031

IG Lintels Ltd

Avondale Road, Cwmbran, Gwent NP44 1XY
www.igltltd.co.uk

tel: 01633 486461
fax: 01633 486495

IMS Group

Arley Road, Saltley, Birmingham, West Midlands
B8 1BB
www.ims-group.com

tel: 0121 326 5000
fax: 0121 326 5005

James Latham plc

Unit 3, Swallow Park, Finway Road, Hemel
Hempstead HP2 7QU
www.lathamtimber.co.uk

tel: 01442 849100
fax: 01442 239287

Loctite UK

Watchmead, Welwyn Garden City, Hertfordshire
AL7 1JB
www.loctite.co.uk

tel: 01707 358800
fax: 01707 358900

Permasteelisa

26 Mastmaker Road, London E14 9UB
www.permasteelisa.com

tel: 020 7531 4600
fax: 020 7531 4610

Pilkington UK Ltd

Prescot Road, St Helens WA10 3TT
www.pilkington.com

tel: 01744 692000
fax: 01744 613044

Pudlo/David Bell Group plc

Huntingdon Road, Bar Hill, Cambridge CB3 8HN
www.pudlo.com

tel: 01954 780687
fax: 01954 782912

Quality Tempered Glass (QTG)

Concorde Way, Millennium Business Park,
Mansfield, Notts NG19 7JZ

tel: 01623 416300
fax: 01623 416303

Richard Lees Steel Decking Ltd

Moor Farm Road West, The Airfield, Ashbourne,
Derbyshire DE6 1HN
www.rlsd.com

tel: 01335 300999
fax: 01335 300888

RMD Kwikform

Brickyard Lane, Aldridge, Walsall WS9 8BW
www.rmdformwork.co.uk

tel: 01922 743743
fax: 01922 743400

Solaglass Saint Gobain

Binley One, Herald Way, Binley, Coventry CV3
2ND
www.saint-gobain-glass.com

tel: 024 76 547400
fax: 024 76 547799

SPS Unbrako Machine Screws

Cranford Street, Smethwick, West Midlands B66
2TA
www.spstech.com

tel: 0121 555 8855
fax: 0121 555 8866

Staytite Self Tapping Fixings

Halifax Road, Cressex Industrial Estate, High
Wycombe HP12 3SE
www.staytite.com

tel: 01494 462322
fax: 01494 464747

Sunglass

via Piazzola 13E, 35010 Villafranca, Padova, Italy
www.sunglass.it

tel: +39 049 9050100
fax: +39 049 9050964

Tarmac Topfloor Ltd

Weston Underwood, Ashbourne, Derbyshire DE6
4PH
www.tarmactopfloor.co.uk

tel: 01335 360601
fax: 01335 360014

Valbruna UK Ltd

Oldbury Road, West Bromwich, West Midlands
B70 9BT
www.valbruna.co.uk

tel: 0121 553 5384
fax: 0121 500 5095

W. J. Leigh

Tower Works, Kestor Road, Bolton BL2 2AL
www.leighspaints.co.uk

tel: 01204 521771
fax: 01204 382115

Zero Environment Ltd

PO Box 1659, Warwick CV35 8ZD
www.zeroenvironment.co.uk

tel: 01926 624966
fax: 01926 624926

Further Reading

Suggested further reading

1 General Information

ACE (1998). *Standard Conditions of Service Agreement B1*, 2nd Edition. Association of Consulting Engineers.

Blake, L. S. (1989). *Civil Engineer's Reference Book*, 4th Edition. Butterworth-Heinemann.

CPIC (1998). *Selected CAWS Headings from Common Arrangement of Work Sections*, 2nd Edition. CPIC.

DD ENV 1991: Eurocode 1. *Basis of Design and Actions on Structures*. BSI.

Hunt, T. (1999). *Tony Hunt's Sketchbook*. Architectural Press.

2 Statutory Authorities and Permissions

DETR (1997). *The Party Wall etc. Act: explanatory booklet*. HMSO.

HSE (2001). *Managing Health & Safety in Construction. CDM Regulations 1994. Approved Code of Practice*. HSE.

HSE (2001). *Health & Safety in Construction*. HSE.

Information on UK regional policies:

www.defra.gov.uk / www.dft.gov.uk / www.odpm.gov.uk / www.wales.gov.uk

www.scotland.gov.uk / www.nics.gov.uk

PTC (1996). *Party Wall Act Explained. A Commentary on the Party Wall Act 1996*. Pyramus & Thisbe Club.

3 Design Data

BS 648: 1970. *Schedule of Weights of Building Materials*. BSI.

BS 5606: 1990. *Guide to Accuracy in Building*.

BS 6180: 1995. *Code of Practice for Protective Barriers In and About Buildings*. BSI.

BS 6399 *Loading for Buildings*. Part 1: 1996. *Code of Practice for Dead and Imposed Loads*. Part 2: 1997. *Code of Practice for Wind Loads*. Part 3: 1988. *Code of Practice for Imposed Roof Loads*. BSI.

- CIRIA Report 111 (1986). *Structural Renovation of Traditional Buildings*. CIRIA.
- Hunt, T. (1997). *Tony Hunt's Structures Notebook*. Architectural Press.
- Information on the transportation of abnormal indivisible loads: www.dft.gov.uk
- Lisborg, N. (1967). *Principles of Structural Design*. Batsford.
- Lyons, A. R. (1997). *Materials for Architects and Builders – An Introduction*. Arnold.
- Morgan, W. (1964). *The Elements of Structure*. Pitman.
- Richardson, C. (2000). The Dating Game. *Architect's Journal*. **23/3/00**, 56–59. **30/3/00**, 36–39. **6/4/00**, 30–31.

4 Basic Shortcut Tools for Structural Analysis

- Bolton, A. (1978). Natural Frequencies of Structures for Designers. *The Structural Engineer*. **No. 9/Volume 56A**, 245–253.
- Calvert, J. R. & Farrer, R. A. (1999). *An Engineering Data Book* Macmillan Press.
- Carvill, J. (1993). *Mechanical Engineer's Data Book*. Butterworth-Heinemann.
- Gere, J. M. & Timoshenko, S. P. (1990). *Mechanics of Materials*, 3rd SI Edition. Chapman Hall.
- Hambly, E. (1994). *Structural Analysis by Example*. Archimedes.
- Johansen, K. W. (1972). *Yield Line Formulae for Slabs*. Cement and Concrete Association.
- Megson, T. H. G. (1996). *Structural and Stress Analysis*. Butterworth-Heinemann.
- Mosley, W. H. & Bungey, J. H. (1987). *Reinforced Concrete Design*, 3rd Edition. Macmillan.
- Sharpe, C. (1995). *Kempe's Engineering Yearbook*, 100th Edition. M-G Information Services Ltd.
- Wood, R. H. (1961). *Plastic and Elastic Design of Slabs and Plates*. Thames & Hudson.

5 Geotechnics

- Berezantsev, V. G. (1961). Load Bearing Capacity and Deformation of Piled Foundations. *Proc. of the 5th International Conference on Soil Mechanics, Paris*, **Vol. 2**, 11–12.
- BS 5930: 1981. *Code of Practice for Site Investigations*. BSI.
- BS 8004: 1986. *Code of Practice for Foundations*. BSI.
- BS 8002: 1994. *Code of Practice for Earth Retaining Structures*. BSI.
- Craig, R. F. (1993). *Soil Mechanics*, 5th Edition. Chapman Hall.
- DD ENV 1997: Eurocode 8. *Geotechnical Design*. BSI.
- Environment Agency (1997). *Interim Guidance on the Disposal of Contaminated Soils*, 2nd Edition. HMSO.

Environment Agency (2002). *Contaminants in Soil: Collation of Toxicological Data and Intake Values for Humans*. CLR Report 9, HMSO.

Hansen, J. Brinch (1961). A General Formula for Bearing Capacity. *Danish Geotechnical Institute Bulletin*. **No. 11**. Also Hansen, J. Brinch (1968). A Revised Extended Formula for Bearing Capacity. *Danish Geotechnical Institute Bulletin*. **No. 28**. Also Code of Practice for Foundation Engineering (1978), *Danish Geotechnical Institute Bulletin*. **No. 32**.

ICRCL (1987). *Guidance on the Redevelopment of Contaminated Land*, 2nd Edition. Guidance Note 59/83, DoE.

Kelly, R. T. (1980). Site Investigation and Material Problems. *Proc. of the Conference on the Reclamation of Contaminated Land*. Society of Chemical Industry. **B2**, 1–14.

NHBC. *National House-Building Council Standards*.

Terzaghi, K. & Peck, R. B. (1996). *Soil Mechanics in Engineering Practice*, 3rd Edition. Wiley.

Tomlinson, M. J. (2001). *Foundation Design and Construction*, 7th edition. Pearson.

6 Timber and Plywood

BS 5268: Part 2: 2002. *Structural Use of Timber*. BSI.

DD ENV 1995: Eurocode 6. *Design of Timber Structures*. BSI.

Ozelton, E. C. & Baird, J. A. (2002). *Timber Designers' Manual*, 3rd Edition. Blackwell.

7 Masonry

BS 5977: Part 1: 1981. *Lintels. Method for assessment of load*. BSI.

BS 5628 *Code of practice for masonry*. Part 1: 1992. *Structural use of unreinforced masonry*. Part 2: 2001. *Materials & components, design & workmanship*. BSI.

CP111: 1970. *Code of Practice for the Design of Masonry in Building Structures*. BSI.

Curtin, W. G., Shaw, G. & Beck, J. K. (1987). *Structural Masonry Designers' Manual*, 2nd Edition. BSP Professional Books.

DD ENV 1996: Eurocode 7. *Design of Masonry Structures*. BSI.

Heyman, J. (1995). *The Stone Skeleton*. Cambridge University Press.

Howe, J. A. (1910). *The Geology of Building Stones*. Edward Arnold. Reprinted Donhead Publishing (2000).

Manual for the Design of Plain Masonry in Building Structures (1997). ICE/StructE.

8 Reinforced Concrete

BS 5328: Parts 1 to 4: 1997. *Concrete Specification and Testing*. BSI.

BS 4483: 1985. BS 4483: 1998. *Steel Fabric for the Reinforcement of Concrete*. BSI.

BS 8110: Part 1: 1997. *Structural Use of Concrete. Code of Practice for Design and Construction*. BSI.

BS 8666: 2000. *Specification for scheduling, dimensioning, bending and cutting of steel reinforcement for concrete*. BSI.

DD ENV 1992: Eurocode 2. *Design of Concrete Structures*. BSI.

DD ENV 1992–4: Eurocode 3. *Liquid Retaining and Containing Structures*. BSI.

Manual for the Design of Reinforced Concrete Building Structures (2002). ICE/StructE.

Mosley, W. H. & Bungey, J. H. (1987). *Reinforced Concrete Design*, 3rd Edition. Macmillan.

Neville, A. M. (1977). *Properties of Concrete*. Pitman.

9 Steel

Baddoo, N. R. & Burgan, B. A. (2001). *Structural Design of Stainless Steel*. Steel Construction Institute, P291.

BS 449: Part 2: 1969 (as amended) *The Use of Structural Steel in Building*. BSI.

BS 5950 *Structural Use of Steelwork in Buildings*. Part 1: 2000. *Code of Practice for Design – Rolled and Welded Sections*. Part 5: 1998. *Code of Practice for Design – Cold Formed Thin Gauge Sections*. BSI.

DD ENV 1993: Eurocode 4. *Design of Steel Structures*. BSI.

MacGinley, T. J. & Ang, T. C. (1992). *Structural Steelwork Design to Limit State Theory*, 2nd Edition. Butterworth-Heinemann.

Manual for the Design of Steelwork Building Structures (2002). ICE/StructE.

Nickel Development Institute (1994). *Design Manual for Structural Stainless Steel*. NIDI, 12011.

Owens, G. W. & Knowles, P. R. (1994). *SCI Steel Designer's Manual*, 5th Edition. Blackwell Science.

SCI (2001). *Steelwork Design Guide to BS 5950: Part 1: 2000 Volume 1 Section Properties and Member Capacities*, 6th Edition. Steel Construction Institute, P202.

10 Composite Steel and Concrete

BS 5950 *Structural Use of Steelwork in Buildings*. Part 3: 1990. *Code of Practice for Design – Composite Construction*. Part 4: 1994. *Code of Practice for Design – Composite Slabs with Profiled Metal Sheeting*. BSI.

DD ENV 1994: Eurocode 5. *Design of Composite Steel and Concrete Structures*. BSI.

Noble, P. W. & Leech, L. V. (1986). *Design Tables for Composite Steel and Concrete Beams*. Constrado.

SCI (1990). *Commentary on BS5950: Part 3: Section 3.1 Composite Beams*. Steel Construction Institute, P78.

11 Glass

Glass and Mechanical Strength Technical Bulletin (2000). Pilkington.

pr EN 13474. *Glass in Building – Design of Glass Panes. Part 1, Basis for Design. Part 2, Design for Uniformly Distributed Loads*. BSI.

Structural Use of Glass in Buildings (1999). IStructE.

12 Building Elements

BRE (2002). *Thermal Insulation Avoiding Risks. A Good Practice Guide Supporting Building Regulation Requirements*, 3rd Edition. BR 262. CRC Ltd.

BS 8007: 1987. *Code of Practice for Design of Concrete Structures for Retaining Aqueous Liquids*. BSI.

BS 8102: 1990. *Protection of structures against water from the ground*. BSI.

BS 8118: Part 1: 1991. *Structural Use of Aluminium. Code of Practice for Design*. BSI.

CIRIA (1995). *Water-resisting basement construction – a guide. Safeguarding new and existing basements against water and dampness*. CIRIA, Report 139.

CIRIA (1998). *Screeds, Flooring and Finishes – Selection, Construction & Maintenance*. CIRIA, Report 184.

DD ENV 1999: Eurocode 9. *Design of Aluminium Structures*. BSI.

General BRE Publications: *BRE Digests, Good Building Guides & Good Repair Guides*.

Guide to the Structural Use of Adhesives (1999). IStructE.

Russell, J. R. & Ferry, R. L. (2002). *Aluminium Structures*. Wiley.

Sources

- ACE (1998). *Standard Conditions of Service Agreement B1*, 2nd Edition. Association of Consulting Engineers. General summary of normal conditions.
- Angle Ring Company Limited (2002). *Typical bend radii for selected steel sections*.
- Berezantsev, V.G. (1961). Load Bearing Capacity and Deformation of Piled Foundations. *Proc. of the 5th International Conference on Soil Mechanics. Paris, Vol. 2*, 11–12.
- Bolton, A. (1978). Natural Frequencies of Structures for Designers. *The Structural Engineer. No. 9/Volume 56A*, 245–253. Table 1.
- BRE Digests 299, 307, 345*. Extracts on durability of timber. Reproduced by permission of Building Research Establishment.
- BS 449: Part 2: 1969 (as amended) *The Use of Structural Steel in Building*. BSI. Tables 2, 11 and 19.
- BS 4483: 1985. BS 4483: 1998. *Steel fabric for the reinforcement of concrete*. BSI. Table 1.
- BS 5268: Part 2: 1991. *Structural Use of Timber*. BSI. Appendix D.
- BS 5268: Part 2: 2002. *Structural Use of Timber*. BSI. Tables 8, 17, 19, 20, 21, 24 and extracts from Tables 28, 31, 33 and 34.
- BS 5328: Part 1: 1997 (to be withdrawn 01/12/2003) *Guide to specifying concrete*. BSI. Tables 13 adapted and 15.
- BS 5606: 1990. *Guide to accuracy in building*. Figure 4.
- BS 5628: Part 1: 1992. *Structural use of unreinforced masonry*. BSI. Tables 1, 5 and 9, extracts from Tables 2 and 3, Figure 3.
- BS 5628: Part 3: 2001. *Materials and components, design and workmanship*. BSI. Table 9 and Figure 6.
- BS 5950 Part 1: 2000. *Structural Use of Steelwork in Buildings. Code of Practice for Design – Rolled and Welded Sections*. BSI. Tables 2, 9, 14 and 22.
- BS 5977: Part 1: 1981. *Lintels. Methods for assessment of load*. BSI. Figures 1 and 4.
- BS 6180: 1995. *Code of Practice for Protective Barriers In and About Buildings*. BSI. Table 1.
- BS 6399 *Loading for Buildings*. Part 1: 1996. *Code of Practice for Dead and Imposed Loads*. BSI. Tables 1 and 4.
- BS 8004: 1986. *Code of Practice for Foundations*. BSI. Table 1 adapted.
- BS 8102: 1990. *Protection of structures against water from the ground*. BSI. Table 1 adapted to CIRIA Report 139 suggestions.
- BS 8110: Part 1: 1997. *Structural Use of Concrete. Code of Practice for Design and Construction*. BSI. Tables 2.1, 3.3, 3.4, 3.9, 3.19, 3.20 and Figure 3.2.

- BS 8118: Part 1:1991. *Structural Use of Aluminium. Code of Practice for Design*. BSI Tables 3.1, 3.2 and 3.3 and small extracts from Tables 2.1, 2.2, 4.1 and 4.2.
- BS 8666: 2000. *Specification for scheduling, dimensioning, bending and cutting of steel reinforcement for concrete*. BSI. Table 3.
- Building Regulations, Part B* (1991). HMSO. Table A2, Appendix A.
- Corus Construction (2002). *Structural Sections to BS4*. Corus.
- CP111: 1970. *Code of Practice for the Design of Masonry in Building Structures*. BSI. Tables 3a and 4.
- CPIC (1998). *Arrangement of Work Sections*, 2nd Edition. CPIC. Selected headings.
- DETR (1997). *The Party Wall etc. Act: explanatory booklet*. HMSO.
- Dow Corning (2002). *Strength values for design of structural silicon joints*.
- Finnforest (2002). *LVL section sizes and grade stresses*.
- Hansen, J. Brinch (1961). A General Formula for Bearing Capacity. *Danish Geotechnical Institute Bulletin*. **No. 11**. Also Hansen, J. Brinch (1968). A Revised Extended Formula for Bearing Capacity. *Danish Geotechnical Institute Bulletin*. **No. 28**. Also Code of Practice for Foundation Engineering (1978), *Danish Geotechnical Institute Bulletin*. **No. 32**.
- Howe, J. A. (1910). *The Geology of Building Stones*. Edward Arnold. Reprinted Donhead Publishing (2000). Table XXVI.
- IG Limited (2002) *Loading data for steel lintels*.
- Kulhawy, F. H. (1984). Limiting Tip and Side Resistance. *Proceedings of Symposium Analysis and Design of Piled Foundations*, edited by Meyer, J. R. California, 80–98. Tables 1 and 2.
- Manual for the Design of Reinforced Concrete Building Structures* (2002). ICE/StructE. Reinforced Concrete Column Design Charts Appendix.
- Manual for the Design of Steelwork Building Structures* (2002). ICE/StructE. Section 11.3, Figures 12, 13, 14 and 15.
- NHBC (2002). *National House Building Council Standards*. Appendix 4.2B and 4.2C.
- Nickel Development Institute (1994). *Design Manual for Structural Stainless Steel*. NIDI, 12011. Tables 3.1, 3.12, 3.5, 3.6 and A.1.
- Pilkington (2000). *Glass and Mechanical Strength Technical Bulletin*. Tables 3, 4, 5, 6, 7 and 8.
- Richardson, C. (2000). The Dating Game. *Architect's Journal*. **23/3/00**, 56–59. **30/3/00**, 36–39. **6/4/00**, 30–31.
- RMD Kwikform (2002). *Loading data and charts for Super Slim Soldiers*.
- Tarmac Topfloor (2002). *Loading data for precast concrete lintels and spiroll hollowcore planks*.
- See the 'Useful Addresses' section for contact details of advisory organizations and manufacturers.

This Page Intentionally Left Blank

Index

- Acceleration due to gravity, 1, 3, 91
- ACE Conditions of Engagement, Agreement
 - B(1), 11–12, 331, 336
- Acoustic joints, 28, 29
- Acrow props, 52
- Active pressure, 107
- Addresses, 320–30
- Adhesives, 284, 288, 294, 302–3
- Adjoining owners, 21–3
- Admixtures, 175
- Aggregates, 61, 175, 176, 178, 307
- Air transport, 48
- Algebraic relationships, 317–18
- 'All up' loads, 42, 206
- Allowable stress see Permissible stress
- Alterations, 17, 18, 19–20
- Aluminium and alloys, 310–13
 - adhesives, 303
 - advantages/disadvantages, 46
 - coatings, 244
 - corrosion protection, 312
 - fire resistance, 308, 312
 - properties, 34, 61, 64
- Ancient Monuments and Archaeology Areas Act 1979, 19–20
- Angle of repose, 99
- Angle Ring Company Ltd, 211, 328, 336
- Angles, 5, 210, 222–5, 224, 255, 271, 312
- Anisotropic materials, 61, 84
- Annealed glass, 284, 285, 286, 287, 289, 291, 292
- Approved Codes of Practice
 - CDM Regulations, 24, 331
 - structural materials, 28, 281, 284, 292
- Arboricultural Association, 18
- Archaeology, 19–20
- Arches, 27, 167, 168, 172
- Architects, 6, 11, 17, 22, 30, 295, 296, 299
- Area
 - columns, 181, 189
 - concrete reinforcement, 182, 183, 186, 187, 203
 - second moment, 4, 67, 76, 212–35, 283
 - sections, 2, 56–9, 67, 119, 212–35, 252, 255
 - units, 2, 3, 4
- 'Areas of archaeological interest', 20
- Association of Consulting Engineers (ACE), 11–12, 320, 331
- Atmospheric conditions, 242, 272
- Austenitic stainless steel, 64, 170, 179, 269, 272, 273, 274
- Axial loading, 28, 67
 - bolted connections, 267
 - masonry, 167
 - reinforced concrete, 181, 196–202
 - steel, 239, 246, 247, 251, 256, 261, 265
 - struts, 79–80
- Axonometric projection, 8
- Balconies, 45
- Balustrades, 44, 45
- Barriers, 44, 45
- Bars
 - bending, 204–5, 206
 - mild steel, 236–7, 252, 253, 255
 - reinforcement, 175, 182, 187, 191, 197–9, 203–6, 276
 - stainless steel, 271
- Basements, 30, 296–8
- Beam bending
 - Clapeyron's equations, 76–7
 - continuous beams, 78
 - deflection formulae, 69–75, 78
 - reinforced concrete, 200–2, 203
 - theory, 67
- Beam lintels, 171
- Beams
 - composite steel and concrete, 275, 277–10
 - continuous, 76–8
 - effective length, 239
 - flanged, 186
 - floor construction, 46, 280
 - glass, 291
 - ladder beams, 54
 - laminated timber products, 120, 121
 - mild steel, 171, 245, 246, 253, 281
 - rectangular, 186, 191, 203
 - reinforced concrete, 180, 181, 185–7, 200–3, 206
 - rigid frame loading, 81–3
 - span/depth ratios, 191, 245, 277
 - stainless steel, 271
 - unit beams, 54
 - universal, 210, 212–15, 251, 253, 277
 - vertical position, 31
- Bearing capacity
 - allowable, 100, 101, 102–5
 - bolted connections, 258–10, 268, 274
 - Brinch Hansen equations, 101
 - foundations, 92, 94, 100–5
- Bearing piles, 93
- Bearing pressures, 92, 100, 165, 167, 265, 267, 291, 293
- Bedrock, 94
- Bending
 - glass, 291, 292
 - mild steel, 211, 247, 251, 253, 256, 262–3, 265
 - radii, 211
 - reinforcement bars, 205–6

- shape codes, 206
- stainless steel, 273
- Bending moments
 - beams, 2, 66, 67, 76–7, 253
 - columns, 196–202
 - concrete slabs, 188, 189, 300
 - struts, 80
 - wall panels, 162–4
- Bending strength
 - aluminium, 313
 - glass, 292
 - masonry, 151
 - steel, 253–4
 - timber, 117, 128, 129, 130
- Berezantsev (1961), 105, 332, 336
- Biaxial bending, 196–202
- Bills of quantities, 6, 10
- Bi-metallic corrosion, 272, 301
- Blending remediation, 116
- Blocks
 - concrete, 62, 64, 141, 142, 143, 147, 153, 160
 - fire resistance, 147
 - floors, 46
 - hollow, 153, 300, 309
 - movement joints, 29, 146
 - shear strength, 157
- Blockwork, 31, 149, 153
- Bolted connections, 304, 305
 - aluminium, 312
 - glass, 288, 289, 290, 293
 - steel, 252, 258–60, 267–8, 272, 274
 - timber, 139–40
- Bolton, A (1978), 91, 332, 336
- Bonding, 22, 145, 313
- Bored piles, 92, 93, 102, 104, 105
- Boreholes, 94
- Borosilicate glass (Pyrex), 284, 288
- Boundary lines, 21–3
- Bracing, 28, 54, 194, 241, 246
- Bricklaying, 307
- Bricks, 34, 62, 141–3, 146, 147, 157, 166–7
- Brickwork
 - bond patterns, 145
 - fire resistance, 147, 309
 - flexural strength, 160–1
 - tolerances, 31
 - vertical load capacity, 149, 153
- Bridge Authority notification, 48–9
- Brinch Hansen, 101
- British Aluminium Extrusions, 311, 328
- British Imperial System, 3, 4, 5
- British Standards *see* Standards
- British Stone, 151, 321
- Brownfield sites, 113
- Buckling
 - aluminium, 310, 313
 - composite steel and concrete, 281
 - glass, 291
 - masonry, 141
 - steel sections, 212–35, 239, 251, 252, 253, 255, 263
 - struts, 79–80
 - timber, 133
- Building Act 1984, 14
- Building regulations, 14–16, 337
 - applications, 14
 - Approved Documents, 14, 30
 - building notices, 14, 16
 - disproportionate collapse, 28
 - 'full plans' submissions, 14, 16
 - glass, 292
 - inspections, 14, 16
 - stage notices, 16
 - straps, 170
 - technical booklets, 16
 - warrants, 15
- Building Regulations 2000, 14
- Building Regulations Approval, 12, 14
- Building Regulations (NI) 2000, 16
- Building Regulations (Northern Ireland) Order 1979, 16
- Building Research Establishment (BRE), 123, 151, 322, 335, 336
- Building (Scotland) Act 1959 (as amended), 15
- Building Standards (Scotland) Regulations 1990 (as amended), 15
- Building warrants, 15
- Buildings
 - ecclesiastical, 17
 - elements, 295–303, 335
 - fire resistance, 30, 308
 - fixings and fastenings, 304–6
 - health and safety files, 24
 - lateral movement, 155
 - listed, 17
 - party walls, 21–3
 - wind loading, 2, 43, 133, 148, 152, 170
- Bulk density, 4, 34–7
- Bulk unit weight, 96, 97, 98
- Buoyant rafts, 93
- Burland & Potts Method, 108
- Buttressing, 28
- Cables, 89–90
- CADW (Wales), 17, 19–20
- Calcium silicate bricks, 141, 142, 146, 160
- California Bearing Ratio (CBR), 98
- Camber, 300
- Cantilevers
 - columns, 28
 - effective length, 241
 - end moments, 77
 - masonry, 148
 - reinforced concrete, 180, 186
 - retaining walls, 93
 - vibration, 91
- Capacity
 - units, 3
- Car parks, 30, 44
- Cast in place concrete *see* In situ concrete
- Castings, 32, 61, 64, 208, 270, 302, 310
- Cavity walls, 146, 148, 150, 159, 172–4, 295, 296, 298
- CAWS (Common Arrangement of Work Sections for Building Work), 10

- CDM (Construction Design & Management Regulations 1994), 12, 24, 331
- Cellular bricks, 147
- Cement, 34, 175, 177, 178, 179, 299
- Cement mortar, 141, 144, 146, 166
- Centre of gravity, 222, 224
- Ceramics, 62, 312
- Certificates
 - completion, 14, 15, 16
 - Lawful Development Certificates, 13
 - self-certification, 15
- Chains, 89
- Characteristic strengths, 61, 156, 160–1, 178, 283, 292
- Charpy notch test, 250
- Chlorinated environments, 114, 272
- Circular sections, 88, 208, 233–4, 251, 252, 253, 317
- Circular structures, 28
- CIRIA Reports, 297–8, 332, 335
- Cladding, 141, 146
- Clamped connections, 294
- Clapeyron's equations, 76–7
- Clay, 34, 94–101, 104, 107, 109
- Clay bricks, 62, 64, 141, 142, 144, 160
 - movement joints, 29, 146
- Coach screws, 306
- Coarse grained soils, 95, 96
- Coatings, 243–5, 312
- Codes of practice, 43, 166–7, 333, 337
 - see also Approved Codes of Practice; Standards
- Coefficient of earth pressure, 105, 107
- Coefficients of friction, 65
- Coffered concrete slabs, 46, 180
- Cohesive soils, 97, 98, 101, 103, 107, 111–12
- Cold rolled steel, 208, 211, 270
- Cold weather working, 307
- Columns
 - composite steel and concrete, 277
 - compressive strength, 153, 166
 - effective length, 241
 - framing moments, 195
 - glue laminated timber, 120
 - load resistance, 156
 - minimum imposed floor loads, 38
 - perimeters, 190
 - reinforced concrete, 180, 181, 189–90, 194–202, 203, 206
 - rigid frame loading, 81–3
 - steel, 245, 246
 - tolerances, 31
 - universal, 210, 216–17, 245, 251, 253, 277
 - verticality, 31
 - yield line analysis, 84–5
- Combined loads, 256, 265, 268, 312
- Commercial buildings, 29, 30, 206, 278
- Common Arrangement of Work Sections for Building Work (CAWS), 10
- Completion certificates, 14, 15, 16
- Composite materials
 - adhesives, 302
 - BS 5950, 281–3
 - durability, 276
 - fire resistance, 276, 281
 - floor construction, 46, 275, 280
 - preliminary sizing, 277–9
 - properties, 62, 276
 - sections, 60
 - span/depth ratios, 277
 - steel and concrete, 60, 275–83, 334
- Compression buckling factor, 133
- Compression capacity, 52, 255–6, 266, 281
- Compression chord bracing, 53
- Compression members, 133, 255, 264
- Compressive strength
 - cast iron, 208
 - glass, 284
 - masonry, 141, 142, 144, 152–3, 156
 - reinforced concrete, 176, 177, 191, 193, 203, 308
 - steel, 251
 - timber, 62
- Compressive stresses, 60, 80
 - cast iron, 208
 - glass, 291, 294
 - masonry, 151, 160, 166, 167
 - reinforced concrete, 170, 176, 191, 193, 203
 - steel, 239, 251, 263–5, 271
 - timber, 128, 129, 130
- Concentrated loads, 165, 167, 281, 293
- Concrete
 - adhesives, 303
 - advantages/disadvantages, 46
 - composite steel and concrete, 59, 275–83, 334
 - cube testing, 178
 - frost action, 179, 307
 - historical use, 32
 - mix design, 177–8
 - piles, 102–3, 105
 - properties, 34, 62, 64
 - waterproofing, 296
 - see also Precast concrete; Prestressed concrete; Reinforced concrete
- Concrete blocks, 62, 141, 142, 143, 147, 153, 160
 - movement joints, 29, 146
- Concrete buildings, 29, 31, 42, 206
- Conditions of Engagement (ACE), 11–12, 331, 336
- Connections
 - fire effects, 309
 - glass, 284, 288, 289, 290, 291, 293–4
 - robustness, 28
 - soldiers, 53
 - steel, 252, 257–10, 266–8, 274
 - timber, 125
 - see also Bolted connections; Joints
- Conservation areas, 18
- Consolidation
 - overconsolidation, 96, 97, 107
 - soils, 94, 96, 97, 104, 109
- Consortia, 7

- Construction
 - management, 7
 - phases, 12, 24
- Construction Design & Management (CDM) Regulations 1994, 12, 24, 331
- Consultants, 11–12, 20
- Contaminated land, 113–16
- Contaminated Land Exposure Assessment (CLEA), 113, 115
- Continuous beams, 78
- Continuous flight auger (CFA) piles, 102–3
- Continuous slabs, 188
- Contractors, 6–7, 11–12
 - archaeology and ancient monuments, 20
 - health and safety, 24
 - tree preservation orders, 18
- Contraflexure, 81, 82
- Conversion factors, 4, 5
- Corners, 172, 190, 293
- Corrosion resistance, 179, 242–4, 269, 272, 273, 288, 301, 312
- Corus Group, 210, 213–35, 242, 244, 323, 328, 337
- Coulomb's theory, 107
- CP111: 1970, 166–7, 333, 337
- CPIC (1998), 10, 331, 337
- Cracking
 - fire effects, 308, 309
 - glass, 284
 - masonry, 141, 146
 - patterns, 84, 86–7
 - prevention, 29, 146, 276, 281, 283, 300
 - retaining walls, 107
- Crane loads, 249
- Creep, 176, 191, 286, 294, 307
- Critical buckling load, 79–80
- Cross bracing, 28, 241
- Cross sections, 88, 119, 211, 251, 252, 313
- Cross walls, 155
- Crushing strength, 62, 151, 178, 240
- Curators, 20
- Damp proofing, 295
- Dead loads, 152, 160, 161, 185, 249, 283, 314
- Decking, 41, 46, 126, 275, 276, 282, 283, 299
- 'Deemed to satisfy' requirements, 14, 16
- Deep foundations, 93, 94, 102
- Deflection
 - beams, 181, 191–3, 246, 278
 - cables, 89–90
 - columns, 196
 - fire effects, 308
 - formulae, 69–76
 - glass, 288, 291, 293, 294
 - limits, 68, 134
 - masonry, 146
 - modification factors, 191–3
 - natural frequency, 91, 279, 283
 - pinned struts, 80
 - plates, 84
 - retaining walls, 107
 - rigid frames, 81–3
 - screeds, 299
 - slabs, 189, 275, 298
 - stainless steel, 270
 - timber, 134
 - units, 2
- Degree of anisotropy, 84
- Demolition work, 15
- Density
 - aluminium, 310
 - glass, 286
 - masonry, 141
 - reinforced concrete, 176, 276
 - steel, 209, 270
 - timber, 118, 128
 - units, 2, 4
- Department for the Environment, Food and Rural Affairs (DEFRA), 115, 331
- Department for Transport (DfT), 47, 332
- Depth
 - hollowcore slabs, 300
 - span/depth ratios, 125, 180, 191, 245, 277
 - steel sections, 26, 212–20, 251, 252, 277
- Depth factors, 132, 186
- Design
 - columns, 196–202
 - composite steel and concrete, 281–3
 - glass, 284, 291–3
 - lintels, 168–9
 - listed buildings, 17
 - load factors and limit states, 66, 117, 313
 - masonry, 152–69
 - mild steel, 249–68
 - quick estimate methods, 101–7
 - reinforced concrete, 185–203
 - stainless steel, 269–74
 - timber, 127–34
- Design and build, 7
- Design data, 25–53, 331–2
- Design moments
 - beams, 185, 201–2
 - columns, 196–202
 - plates, 85
 - slabs, 188, 189
 - stanchions, 248
- Design process, 6–7, 11–12, 24
- Design strengths, 165, 182, 250, 251, 281
- Design stresses, 66, 258, 294
- Designated concrete mixes, 177, 178
- Details (drawings), 8
- Developers, 19–20
- Diaphragm action, 28, 299, 300
- Differentiation, 319
- Disproportionate collapse, 28, 291
- Distributed loads, 2, 69, 78, 80, 168–9, 171, 245
- District councils (NI), 16
- Documentation, 6–7
- Double tee beams, 46
- Dow Corning Ltd, 294, 328, 337
- Drainage, 296, 298, 299
- Drained soils, 96–7
- Drawings, 6, 11–12, 119
 - conventions, 8–9
 - health and safety information, 24
- Driven piles, 92, 93, 102, 105
- Dry rot, 122

- Dry unit weight, 96
- Ductility, 208, 211, 250, 269, 270
- Duplex stainless steel, 60, 269, 270, 271, 272, 273
- Durability, 122–3, 147, 179–80, 242–4, 272, 276, 288, 312, 313
- Durbar mild steel, 238

- Earth pressure, 2, 105, 107, 152, 185, 249
- Eccentricity, 28, 52, 156, 167, 196
- Ecclesiastical buildings, 17
- Edges, 190, 281, 289, 293
- Effective depth, 185, 196
- Effective height, 155
- Effective internal angle of shearing resistance, 96, 97, 99, 101, 105
- Effective length, 79, 85, 133, 155, 194, 239–41
- Effective overburden pressure, 101, 105, 107
- Effective stresses, 96, 98
- Effective thickness, 154
- Elastic properties, 60–2, 66, 88
 - beam bending theory, 67
 - glass, 284, 291, 292
 - reinforced concrete, 189
 - steel, 261, 271
 - units, 2, 4
- Elongation at failure, 60, 62, 273
- Embedded retaining walls, 108
- End moments, 77, 195
- Energy efficiency, 291
- England and Wales
 - archaeology and ancient monuments, 19, 20
 - building regulations, 14
 - listed buildings, 17
 - planning regulations, 13
- English Heritage (EH), 17, 19–20, 323
- Environment Agency, 113, 323, 332, 333
- Environment and Heritage Service (EHS), 17, 19–20, 323
- Environmental Protection Act 1990, 113
- Equal/unequal angles, 210, 222–5, 224, 255, 271, 312
- Euler's theory, 79–80
- Eurocodes, 92, 117, 292, 331, 332, 333, 334, 335
- European standards *see* Standards
- Excavations
 - angle of repose, 99
 - archaeology and ancient monuments, 19, 20
 - bearing pressures, 100
 - contaminated land remediation, 116
 - party walls, 21–3
 - site investigation, 94
- Expansion, 64, 144, 146, 176, 209, 270, 285, 310
- External cavity wall panels, 150, 159
- External use, 41, 289, 291
- Extrusions, 311, 312

- Facings, 141, 142
- Factors of safety, 67, 92, 101, 104, 105
 - aluminium, 313
 - composite steel and concrete, 281
 - glass, 292, 294
 - masonry, 151, 152, 161
 - reinforced concrete, 185, 206
 - steel, 249, 273
- Failure
 - crack patterns, 84, 86–7
 - elongation, 61, 62, 273
 - glass, 284, 291, 294
 - masonry, 160
- Fastenings, 304–6
- Feasibility, 11
- Federation of Piling Specialists, 106, 324
- Ferritic stainless steel, 64, 269, 274
- Fibreboard, 117
- Fibres, 62, 63, 64, 67, 175, 284, 312
- Field studies, 20
- Fillets, 212, 214, 216, 218, 220, 257, 266, 306
- Fine grained soils
 - classification, 95
 - cohesive strength, 97
 - foundations, 92, 109
 - pore water pressure, 96
 - see also* Clay; Silt
- Finnforest, 121, 329, 337
- Fins, 290, 291
- Fire resistance
 - aluminium, 308–9, 312
 - composite steel and concrete, 276, 281
 - concrete, 171, 180, 300
 - contaminants, 114
 - glass, 288
 - masonry, 147
 - protection, 245, 367
 - stainless steel, 272
 - structural elements, 30
 - timber, 124
- Fixings, 304–6
 - see also* Bolted connections; Nailed joints; Screwed joints
- Fixity, 85
- Flanges
 - mild steel, 210, 212–21, 226–32, 251–3, 262–3, 281, 282
 - reinforced concrete, 186, 191, 282
 - restraint, 239, 240, 241
 - stainless steel, 271
- Flat bars, 237, 255
- Flat roofs, 41
- Flat slabs, 189–90
- Flatness of floors, 31
- Flettons, 166, 167
- Flexible partitions, 41
- Flexural members, 132, 252
- Flexural strength, 141, 144, 152, 160–1, 295
- Float glass, 62, 64, 285, 287
- Floors
 - area, 2
 - composite materials, 46, 275, 280
 - concrete slabs, 41, 42, 46, 275, 301
 - construction selection, 47
 - drained, 296

- Floors – continued
 - Durbar mild steel plates, 238
 - flatness, 31
 - joist capacity, 126
 - laminated glass, 289
 - lateral restraint, 155
 - minimum imposed loads, 38–40
 - screeds, 299
 - strapping, 170
 - unit loadings, 41
 - vertical position, 31
 - vibration, 91
 - waterproofing, 296, 298
- Footings, 93, 94, 100, 101, 206
 - see also Foundations
- Force
 - diagrams, 26–7
 - units, 1, 2, 3, 4
- Fork heads, 52
- Formwork, 175, 181, 275, 307
- Foundations
 - 'all up' loads, 42
 - bearing capacity, 92, 94, 100–5
 - BS 8004, 92
 - deep, 93, 94, 102
 - depth, 92, 93, 109, 111–12
 - fine grained soils, 92
 - geotechnics, 92
 - lateral load transfer, 28
 - minimum imposed floor loads, 38
 - party walls, 23
 - preliminary sizing, 100–6
 - raft, 93, 94, 206
 - selection, 93
 - shallow, 92, 93, 94, 101, 109–12
 - special, 23
 - see also Footings
- Frame action, 28
- Frames
 - braced, 246
 - moments, 195, 196
 - portal, 27, 246–7
 - rigid, 81–3
 - subframes, 82, 189, 196
- Free ends, 77
- Freehand scale drawings, 8–9
- Freestanding walls, 161
- Frequency of vibration, 91, 279, 283
- Friction, 65, 91, 104, 105, 293
- Friction grip connections, 294
- Friction piles, 93, 104
- Frost action, 92, 147, 179, 300, 307
- Fungal attack, 122, 302
- Gable walls, 150
- Galvanized steel, 169, 170, 172, 244, 301
- Galvanizers' Association, 242, 324
- Gaskets, 291, 301
- General arrangement (GA), 8
- Geometric section properties, 55–9
- Geophysical prospecting, 20
- Georgian wired glass, 288
- Geotechnics, 92–116, 332–3
- Girders, 26, 245–6, 262
- Glass, 284–94, 335
 - adhesives, 284, 288, 294, 303
 - curved, 287
 - durability, 288
 - fibres, 62, 64, 175, 288
 - fire resistance, 288, 308
 - glazing, 290
 - mullions, 290
 - products, 285–6
 - properties, 62, 64, 286
 - section sizes and thicknesses, 287, 289–10, 291
 - standards, 292
 - tolerances, 294
 - wired, 288
- Glass and Glazing Federation, 292, 293, 324
- Glue laminated timber (glulam), 117, 120, 129, 134
- Glued joints, 303, 313
- Grades
 - listed buildings, 17
 - mild steel, 250, 261–8
 - stainless steel, 269, 272, 273, 274
 - timber, 128–9, 130, 132, 133, 140
- Grants for listed buildings, 17
- Granular soils, 95, 96, 100, 102, 105
- Gravel, 93, 95, 99, 100, 101
- Gravity, 1, 3, 91, 222, 224
- Gravity retaining walls, 93, 108
- Gross weight of vehicles, 47
- Ground movement, 29, 93
- Groundwater, 296
- Handrail loadings, 44
- Hardening time
 - mortar, 166
- Hardstanding, 29
- Hardwoods, 117, 118, 122, 123, 134, 135–6, 138
- Haunch length, 277
- Health and safety, 12, 24, 330
- Health and Safety Executive (HSE), 24, 143
- Heat resistant steels, 269
- Heat soaked glass, 286, 287, 291
- Heat treatment, 310, 311
- Height
 - acrow prop sizes, 52
 - columns, 81, 82, 181, 194
 - glass sections, 290
 - mild steel sections, 210
 - structural movement joints, 29
 - units, 2
 - vehicles and loads, 50–1
 - walls, 155, 161
- Heterogeneous materials, 95
- Highways Authority notification, 48–9
- Historic Monuments and Archaeology Objects (NI) Order 1995, 19
- Historic Scotland, 17, 19–20
- Historical use of building materials, 32–3, 166, 167, 175, 208
- Hogging moments, 66, 86, 189
- Holes
 - beams, 277, 278, 281
 - glass, 293

- steel connections, 258, 267, 268
- timber joints, 135, 137, 139
- Hollow sections
 - circular, 208, 210, 233–5, 251, 252, 253
 - rectangular, 208, 210, 226–9, 251, 252, 253
 - square, 208, 210, 230–2, 251, 253
- Hollowcore slabs, 299
- Home Office, 17
- Homogeneous materials, 61, 67, 95
- Hooke's law, 67
- Horizontal deflection limits, 68
- Horizontal shear stress distribution, 67, 283
- Hot dip galvanizing, 243
- Hot finished hollow sections, 208, 210, 226–35, 245, 251, 252, 253, 255
- Hot rolled steel sections, 208–74, 255, 270, 271
- Howe, J A (1910), 151, 333, 337
- I G Limited, 172, 174, 329, 337
- ICRCL list, 113, 333
- Impact resistance, 291
- Imperial units, 3, 4, 5
- Imposed loads, 38–42, 44, 152, 185, 249, 284, 314
- In situ concrete, 10, 31, 102, 105, 275
- Industrial buildings, 29, 30, 206
- Industrial contaminated land, 113–16
- Insect attack, 123
- Inspection, 12, 14, 16, 22, 296
- Institution of Structural Engineers' Grey Book* (IStructE), 246–7
- Institutional buildings, 30, 206
- Integration, 319
- Internal angle of shearing resistance, 96, 97, 99, 101, 105
- Internal use, 41, 289
- International Standards
 - see Standards
- International System of Units (SI), 1–2, 4, 5
- Intumescent materials, 245, 288, 311
- Isolation
 - contaminated land remediation, 116
 - glass, 291
- Isometric projection, 8
- Isotropic materials, 67, 84
- IStructE publications, 200, 246–7, 292, 334, 335, 337
- Jetted piles, 105
- Johansen's yield line theory, 84–7, 332
- Joints
 - acoustic, 28, 29
 - aluminium, 313
 - glued, 303, 313
 - nailed, 135–6, 304
 - pinned, 81
 - screwed, 137–8, 304–5
 - silicone, 288, 294
 - spacing, 29
 - structural movement, 29, 146
 - timber, 135–40
- Joist hangers, 169–70
- Joists
 - rolled steel, 217–18, 251
 - timber, 46, 125, 126, 132
- Kelly, R T (1980), 113, 333
- Key elements, 28
- Kiln drying, 118, 122
- Kulhawy, F H (1984), 105, 337
- Ladder beams, 54
- Laminated glass, 286, 287, 288, 289, 291
- Laminated timber products, 117, 120–1, 129, 134
- Laminated veneered lumber (LVL), 117, 120, 130
- Land use, 113, 115
- Lateral loads
 - beam bending, 67
 - earth pressure, 107
 - masonry, 144, 148, 155, 161, 162–4
 - plates, 84
 - rigid frames, 81–3
 - stability, 28
 - struts, 80
- Lateral restraint, 155, 239–41, 253
- Lateral torsional buckling (LTB), 239, 253
- Law of the Tenement, 21
- Lawful Development Certificates, 13
- Lead consultants, 11–12
- Length
 - acrow prop sizes, 52
 - columns, 194
 - fixings, 304–6
 - hollow sections, 226–35, 251
 - hollowcore slabs, 300
 - ladder beams, 54
 - lintels, 168, 171–4
 - partitions, 151
 - piles, 102–3, 105
 - plates, 85
 - soldiers, 53
 - spans, 69, 76, 126
 - struts, 79
 - torsion, 88
 - unit beams, 53
 - units, 1, 3, 4
 - vehicles and loads, 49–50
 - vibration, 91
 - walls, 155
 - see also Effective length
- Lever arm, 186
- Lightweight construction, 91, 283
- Lime mortar, 141, 144, 166, 167
- Limit states, 55, 117, 311
- Limiting criteria, 25
- Line loading, 4
- Linear coefficient of thermal expansion, 63, 176, 209, 270, 286, 310
- Lintels, 168–9, 171–4
- Listed buildings, 17

- Load capacity
 - acrow props, 51
 - floor joists, 126
 - glass, 291
 - hollowcore slabs, 300
 - joist hangers, 169–70
 - soldiers, 52
 - walls, 149, 150, 167
- Loads
 - cables, 89–90
 - columns, 181, 246
 - combined effects, 256, 265, 268, 313
 - concentrated, 165, 167, 281, 293
 - dead, 152, 160, 161, 185, 248, 283, 313
 - deflection formulae, 69–75
 - distributed, 2, 69, 78, 80, 168–9, 171, 245
 - factor design, 55, 117, 195, 313
 - floors, 38–41
 - foundations, 41
 - glass, 288, 292, 294
 - imposed, 38–42, 44, 152, 185, 249, 284, 313
 - joints, 135–40
 - lintels, 168–9, 171–4
 - load sharing, 132, 133, 134
 - modification factors, 131
 - partitions, 41, 279–90
 - point, 2, 69, 78, 85, 125, 168–9, 245, 283, 289
 - reinforced concrete, 185, 276
 - roofs, 41
 - slabs, 189–90
 - static, 100
 - Steel, 249
 - types, 152
 - unfactored, 92, 127, 195, 278, 292
 - units, 2
 - vehicles, 47–8
 - see also Axial loads; Lateral loads; Wind loading
- Local authorities
 - archaeology and ancient monuments, 19–20
 - building regulations, 14, 15, 16
 - conservation areas, 18
 - groundwater draining, 296
 - listed buildings, 17
 - planning regulations, 13, 18
 - tree preservation orders, 18
- Location plans, 8
- London Building Act, 14
- Longitudinal forces, 257, 271, 283
- Machine screws, 306
- Main contractors, 6, 7, 24
- Maintenance, 24, 296
- Management contractors, 7, 11
- Manual handling, 143
- Martensitic stainless steel, 274
- Masonry, 10, 141–74, 332
 - accessories, 169–74
 - advantages/disadvantages, 46
 - BS 5628, 144, 151, 152–65
 - CP111: 1970, 166–7, 333
 - cracked section, 141
 - durability, 147
 - fire resistance, 147, 309
 - flexural strength, 141, 144, 152, 160–1
 - friction coefficient, 65
 - geometry, 143–6
 - historical use, 32
 - openings, 150, 168–9, 171
 - porosity, 147
 - preliminary sizing, 148–52
 - reinforced, 148, 159
 - salt content, 147
 - shear strength, 151, 157
 - shrinkage, 146
 - span/thickness ratios, 148
 - unit strengths, 142
- Masonry structures, 28, 29, 42, 146
- Mass
 - concrete reinforcement, 183
 - masonry, 144
 - mild steel sections, 212–35
 - units, 1–4
 - vibration, 91
- Materials
 - Approved Codes of Practice, 28, 281, 284, 292
 - fire effects, 308–9
 - historical use, 32–3
 - properties, 61–5
 - selection, 46
 - weights, 34–7
- Mathematical formulae, 314–19
- Maximum deflection, 68–76
- Measurement
 - angles, 5
 - conversion factors, 4, 5
 - imperial units, 3, 4, 5
 - metric units, 1–2, 4, 5
- Medieval fill, 19
- Membranes, 295, 296, 299
- Metal deck
 - floor construction, 46, 126, 275, 298
 - roof loadings, 41
- Metal Sprayers Association, 242
- Metallic coatings, 244, 312
- Metals
 - contaminants, 114
 - fire effects, 308
 - fixings, 305
 - properties, 34, 61, 64, 65
- Metric units, 1–2, 4, 5
- Mild steel
 - bars, 236–7, 252, 255
 - concrete reinforcement, 175, 206
 - corrosion protection, 243, 302
 - flat bars, 237, 255
 - historical use, 32, 207
 - plates, 238, 251, 252
 - properties, 61, 64
 - round bars, 236, 255
 - section sizes and tolerances, 210–38
 - straps, 170
- Mineral Policy Guidance Notes (MPGs), 13

- Mitigation, 19, 20
- Modular ratio, 276
- Modulus of elasticity
 - aluminium, 309
 - glass, 286
 - materials, 61–3
 - reinforced concrete, 176, 308
 - steel, 209, 213–35, 270
 - structural analysis, 55, 59, 67
 - timber, 29, 128, 130
 - units, 2, 4
 - vibration, 91
- Modulus of rigidity, 209, 310
- Moisture
 - adhesives, 302
 - bricklaying, 307
 - damp proof courses, 294
 - movement joints, 29, 144
 - screeds, 299
 - soils, 92, 94, 96
 - timber, 118, 122, 128
 - waterproofing, 29, 147, 177, 295–9
- Moment capacity
 - composite steel and concrete, 281–3
 - concrete beams, 186
 - ladder beams, 54
 - slimshors, 53
 - steel, 253
 - unit beams, 54
- Moments
 - beam bending, 66, 67–75, 78
 - Clapeyron's equations, 76–7
 - columns, 194–5
 - concrete columns, 181
 - diagrams, 26–7
 - lintels, 172–4
 - reinforced concrete, 185–6, 189–90
 - rigid frame loading, 81–3
 - units, 4
 - yield line analysis, 84–7, 161
- Moments of inertia, 2, 67, 78, 88, 91
- Mortar
 - cement mortar, 141, 144, 146, 166, 309
 - damp proof courses, 295
 - fire resistance, 308
 - frost action, 306
 - lime mortar, 141, 144, 166, 167
 - masonry strength, 153, 157
 - stone masonry, 151
 - sulphate resisting, 147
- Motor Vehicles (Authorization of Special Types)
 - General Order 1979, 47
- Motor Vehicles (Construction & Use)
 - Regulations 1986, 47
- Movement joints, 29, 146
- Mullions, 290
- Multi-storey buildings see Storeys
- Multiple spans, 77
- Nailed joints, 135–6, 304
- National House Building Council (NHBC), 109, 110, 111, 112, 325, 333, 337
- National Planning Policy Guidelines (NPPGs), 13, 19
- Natural frequency, 91, 279, 283
- Nautical measure, 3
- Negative skin friction, 104, 105
- Netherlands, 113
- Neutral axis, 186, 281, 282
- Nickel Development Institute (NIDI), 271–4, 325, 334, 337
- Nickel sulphide inclusions, 285–6, 291
- Non-residential buildings, 30, 38, 44, 278
- Northern Ireland
 - archaeology and ancient monuments, 19, 20
 - building regulations, 16
 - Department of Finance and Personnel, 16
 - listed buildings, 17
 - planning regulations, 13
- Northern Ireland Buildings Database, 17
- Notices to Adjoining Owners, 21–3
- Novation, 7
- Office of the Deputy Prime Minister (ODPM), 13, 14, 331
- Offices, 30, 38, 44, 278
- Openings, 150, 168–9, 171, 278
- Orthogonal properties, 28, 152, 160, 161, 162–4, 188
- Orthographic projection, 8
- Orthotropic materials, 61, 141
- Overconsolidated clays, 96, 97, 107
- Overconsolidation ratio (OCR), 107
- Overcrowding, 39, 40, 44
- Overhanging loads, 49
- Overturning stability, 67
- Pad footings, 93, 101, 206
- Padstones, 171
- Paint coatings, 242, 243, 245, 300, 307, 311
- Panels
 - bending moment coefficients, 162–4
 - external cavity walls, 150, 159
 - flexural strength, 161
 - laminated veneered lumber, 117, 121
 - masonry, 146, 148, 150, 152, 161, 162–4
 - panel factor, 152, 162–4
 - reinforced concrete, 188
 - stressed skin ply, 27, 46, 125
 - wind loading, 158, 159
- Parallel axis theorem, 59
- Parallel flange channels (PFC), 210, 220–1, 251, 253
- Parapets, 44, 45
- Partial factors of safety, 66, 152, 185, 249, 273, 281, 313
- Particle size
 - soil classification, 95
- Particleboard, 117
- Partitions, 41, 151, 279–81
- Partnering, 7
- Party fence walls, 21
- Party structures, 21
- Party Wall Awards, 22
- Party Wall etc. Act 1996, 21–3, 331, 337

- Passive pressure, 107, 108
 - Peak shear, 67
 - Peat, 95, 99, 100
 - Perforated bricks, 147
 - Permanent partitions, 41
 - Permissible stresses, 66
 - glass, 292, 294
 - masonry, 149, 166, 167, 171
 - steel, 261–5, 267
 - timber, 117, 127, 135, 137, 139
 - Perpends, 145
 - Perry–Robertson theory, 79–80
 - Physical activity floor loads, 39, 40
 - Piers, 93, 151, 153, 154, 155, 166, 168
 - Piles
 - angle, 105
 - caps, 106, 206
 - dimensions, 102–6
 - geotechnics, 92, 94
 - group action, 104
 - maximum allowable capacities, 102–5
 - negative skin friction, 104, 105
 - selection, 93
 - spacing, 102, 104
 - tolerances, 106
 - Pilkington UK Ltd, 285, 287, 290, 292, 329, 335, 337
 - Pinned joints, 81
 - Pinned struts, 80
 - Pitched roofs, 41
 - Plan position, 31
 - Plane frames, 81–3
 - Planning Advice Notes (PANs), 13
 - Planning and Building Regulations (Northern Ireland) (Amendment) Order 1990, 16
 - Planning (Listed Buildings and Conservation Areas) (Scotland) Act 1997, 13
 - Planning (NI) Order 1991, 13
 - Planning Policy Guidance Notes (PPGs), 13, 19
 - Planning Policy Statements (PPSs), 13, 19
 - Planning regulations, 11, 13, 18, 19–20
 - Planning supervisors (PS), 24
 - Plastic hinges, 246–7, 249
 - Plastic modulus, 55, 213–35, 253
 - Plastic moment capacity, 251, 253, 281–2
 - Plastic properties, 66, 94
 - Plasticity index (PI), 97, 98, 109
 - Plastics, 63, 175, 303, 305
 - Plate girders, 245, 246, 262
 - Plates, 84–7, 139, 174, 238, 251, 252, 271, 311
 - Platforms, 53
 - Plywood, 117–40, 333
 - adhesives, 302
 - BS 5268, 130–3
 - diagrams, 27
 - joints, 136, 138
 - sources, 120, 130
 - stressed skin panels, 27, 46, 125
 - Podger dimensions, 304
 - Point loads, 2, 69, 78, 85, 125, 168–9, 245, 283, 290
 - Poisson's ratio, 61–2, 67, 209, 270, 286, 310
 - Polar moments, 88
 - Pollution, 113–16, 242, 272
 - Polymers, 63, 64
 - Polyvinyl butyral (PVB), 286
 - Pore water pressure, 96
 - Portal frames, 27, 246–7
 - Portland Cement, 175
 - Post tensioned flat slabs, 46, 180
 - Pozzolanic materials, 141, 144, 166
 - Pre-construction phase, 11–12
 - Precast concrete, 10
 - floor slabs, 41, 46, 275, 276, 299, 300
 - hollowcore slabs, 300
 - piles, 102, 105
 - tolerances, 31
 - Prescribed concrete mixes, 177, 178
 - Pressure
 - units, 4
 - Prestressed concrete, 46, 102, 171, 309
 - Price & Myers (2001), 206
 - Primary movement joints, 29
 - Principal contractors, 6, 7, 24
 - Procurement, 6–7, 11
 - Profiled sections, 172–4, 181
 - Projecting loads, 48
 - Projections (drawing), 8
 - Proof stress, 61, 273, 274, 291
 - Propped embedded retaining walls, 108
 - Public buildings, 28
 - Punching shear, 190
 - Pyrex, 284, 288
-
- Quantity surveyors, 6
 - Quantity of unit, 34–7
-
- Radius of curvature, 67, 287
 - Radius of gyration, 2, 213–35, 240
 - Raft foundations, 93, 94, 206
 - Rafters, 132, 246, 247
 - Rail transportation, 47
 - Rain effects, 307
 - Ramps, 9
 - Rankine's theory, 107
 - Reactions
 - beam bending and deflection, 69–75, 78
 - lateral restraint, 155, 239–41, 253
 - rigid frame loading, 81, 82
 - Record keeping
 - archaeology and ancient monuments, 20
 - Recreational buildings, 30
 - Rectangular sections
 - beams, 186, 191, 203
 - hollow, 208, 210, 226–9, 251, 252, 253
 - Refurbishment, 7, 166
 - Regional Policy Guidance Notes (RPGs), 13
 - Reinforced concrete, 175–206, 333–4
 - beams, 180, 181, 185–7, 200–3, 206
 - BS 8110, 179, 180, 185–203
 - columns, 180, 181, 189–90, 194–202, 203, 206
 - constituents, 175, 177, 178, 179
 - durability, 179–80
 - fire resistance, 180, 308, 309
 - formwork, 175

- foundations, 23
- junctions, 28
- mix design, 177–8
- piles, 102
- preliminary sizing, 180–1, 188
- properties, 176
- retaining walls, 180, 206
- shrinkage, 176
- slabs, 41, 42, 46, 180, 181, 188–90, 203, 206, 276, 281–3, 299
- span/depth ratios, 180, 277
- yield line analysis, 84
- Reinforcement
 - area, 2, 182, 183, 184, 187
 - bars, 175, 182, 187, 191, 197–9, 203–6, 276
 - estimates, 206
 - links, 175, 184, 187
 - mesh, 175, 183, 276, 281, 283
 - percentage, 203
 - spacing, 2, 182, 184, 187
- Remedial work
 - basement waterproofing, 296, 299
 - contaminated land, 113, 116
- Repair
 - listed buildings, 17
- Residential buildings, 17, 30, 38, 44
- Residual stresses, 208, 285, 309
- Retail areas, 30, 38, 44
- Retaining walls
 - BS 8002, 92, 108
 - diagrams, 27
 - geotechnics, 92, 107
 - preliminary sizing, 108
 - reinforced concrete, 180, 206
 - selection, 93
 - waterproofing, 147, 296
- RIBA (Royal Institute of British Architects), 11, 326
- Richardson, C (2000), 32–3, 332, 337
- Rigid frames, 81–3
- Rigidity, 208
- Risk assessments, 12, 24, 115, 116
- RMD Kwiform, 53, 330, 337
- Road Traffic Act 1972, 48
- Road transport, 47–50
- Road Vehicles Lighting Regulations 1989, 47
- Robustness, 28, 170, 239
- Rock, 99, 100
- Rolled steel
 - equal/unequal angles, 210, 222–5, 224, 255, 271
 - joists, 217–18
- Roofs, 29, 30, 41, 155, 170, 295
- Root radius, 212–25
- Royal Institute of British Architects (RIBA), 11, 326
- Rusting, 242–4
- Safety see Factor of safety; Health and safety
- Safety glass, 284, 289
- Sagging moments, 66, 85, 86, 189
- Sampling, 115, 178
- Sand, 93, 94, 95, 100
- Saturated soils, 96
- Scaffolding, 54
- Schedules, 6, 204
- SCI Blue Book* (2002), 249, 334
- Scotland
 - archaeology and ancient monuments, 19, 20
 - building regulations, 15
 - listed buildings, 17
 - planning regulations, 13
- Screeds, 31, 299
- Screwed joints, 137–8, 304–5
- Sea transport, 48
- Seasonal changes, 92
- Seasoning wood, 118
- Seawater exposure, 179, 242, 272, 312
- Secant modulus, 270, 271
- Second moment of area, 4, 67, 76, 212–35, 283
- Secondary movement joints, 29
- Sections
 - aluminium, 312
 - area, 2, 55–8
 - beam bending theory, 67
 - bend radii, 211
 - classification, 250
 - composite, 60
 - dimensions, 2, 56–9, 119, 210–38
 - hollow, 208, 210, 226–35, 245, 251, 252, 253, 255
 - mild steel, 210–38
 - moduli, 2, 4, 55, 67
 - plywood, 130
 - properties, 55–9
 - sign conventions, 66
 - slimshors, 53
 - stainless steel, 271
 - timber, 119–21
- Self-certification, 15
- Self-tapping screws, 305
- Sensitivity testing, 94
- Serviceability limit state (SLS), 66
- Settlement, 92, 94, 96, 109, 146
- Sexagesimal system, 5
- Shallow foundations, 92, 93, 94, 101, 109–12
- Shape factor, 55, 57, 59
- Shear
 - beam bending theory, 67
 - joints, 136, 138, 140, 258
 - ladder beams, 53
 - reinforced concrete beams, 185
 - rigid frame loading, 82
 - steel sections, 265, 267
 - unit beams, 54
- Shear capacity, 187, 252, 258–60, 265, 266, 268, 282, 283, 290
- Shear centres, 28
- Shear forces, 66, 188, 190, 253
- Shear link reinforcement, 184
- Shear modulus of elasticity, 60–1, 67, 88, 128, 270

- Shear resistance, 187, 281, 283
- Shear strain, 67, 88
- Shear strength
 - bolted connections, 274
 - masonry, 151, 157
 - soils, 94, 96, 97, 98, 104
 - timber, 62
 - see also Effective internal angle of shearing resistance
- Shear stresses, 67, 88
 - cast iron, 208
 - composite steel and concrete, 282–3
 - glass, 294
 - masonry, 151
 - reinforced concrete, 187, 188, 190
 - soils, 96, 98
 - steel, 253, 265
 - timber, 125, 128, 129, 130
- Shear studs, 275, 278, 281, 283
- Shear wall, 241
- Shops, 30, 38, 44
- Shrinkage, 97, 111–12, 118, 146, 176, 298
- Shuttering, 175, 181, 307
- SI units, 1–2, 4, 5
- Sieve sizes, 95
- Sign conventions, 65
- Silicones, 288, 294
- Silt, 93, 95, 97–100, 109
- Single piles, 104
- Site investigations, 11–12
 - BS 5930, 92, 94
 - contaminated land, 115
 - foundation selection, 93, 94
 - plans, 8
- Sizing
 - aluminium, 312
 - composite steel and concrete, 277–80
 - external cavity wall panels, 150, 159
 - foundations, 100–6
 - glass, 287, 289–90, 291
 - masonry, 148–52
 - reinforced concrete, 180–1, 188
 - retaining walls, 107–8
 - stainless steel, 273, 274
 - steel elements, 210–38, 245–7
 - timber elements, 125–6
- Sketches, 8–9
- Skin friction, 104, 105
- Slabs
 - crack patterns, 84, 86–7
 - floor construction, 46, 275, 300
 - hollowcore, 300
 - loadings, 41, 42
 - steel, 262
 - yield line analysis, 84–7
 - see also Concrete
- Slenderness
 - masonry, 151, 155, 156, 167
 - reinforced concrete, 194, 196
 - steel, 239–41, 251, 255, 263–4
 - timber, 131, 133
- Slimshors, 53
- Slip resistance, 291
- Slopes, 9
- Slump, 177
- Snow effects, 249, 306
- Soffits, 180, 283
- Softwoods, 117, 118, 122, 123, 125, 130, 134, 135–6, 138
- Soil Guideline Values, 113, 115
- Soils
 - angle of repose, 99
 - bearing capacity, 100
 - classification, 95
 - cohesive, 97, 98, 101, 104, 107, 111–12
 - consistency, 95
 - consolidation, 94, 96, 97, 104, 109
 - contamination, 113–16
 - drained, 96–7
 - foundation selection, 93
 - geotechnics, 92
 - moisture content, 92, 94, 96
 - permeability, 94
 - plasticity index, 97, 98, 109
 - properties, 96–9
 - retaining wall selection, 93
 - settlement, 92, 94, 96, 109
 - shear strength, 94, 96, 97, 98, 104
 - shrinkability, 97, 111–12
 - site investigation, 94
 - stress, 105
 - treatment, 116
 - undrained, 96–8
- Soldiers, 53
- Spanner dimensions, 305
- Spans
 - beam bending and deflection formulae, 69, 76
 - Clapeyron's equations, 76–7
 - glass, 289, 291
 - hollowcore slabs, 300
 - lintels, 168–9, 171–4
 - masonry, 148, 150, 161, 168–9
 - multiple, 77
 - reinforced concrete, 180–1, 185, 188, 189–90, 191, 275, 276, 278–80
 - span/depth ratios, 125, 148, 180, 191, 245, 277
 - steel, 245, 246
 - timber, 125, 126, 134
 - units, 2
 - vibration, 91
- 'Special architectural or historic interest', 17, 18
- Specific weight, 61–3
- Specifications, 6, 10, 11–12, 119, 204
- Spread footings, 101
- Sprinklered buildings, 30
- Square bars, 236, 253, 255
- Square hollow sections (SHS), 208, 210, 230–2, 249, 251
- Squareness, 209
- Stability, 28, 29, 66, 194, 253
- Stainless steel
 - adhesives, 303
 - BS 5950, 269–74
 - connections, 274

- corrosion resistance, 244, 269, 272, 273
- durability, 272, 288
- elastic properties, 271
- fire resistance, 272
- grades, 269, 272, 273, 274
- historical use, 33
- joist hangers, 169
- preliminary sizing, 273, 274
- properties, 61, 64
- reinforced concrete, 179
- sections, 271
- straps, 170
- vertical joints, 146
- Stairs, 9, 191, 206, 289
- Stanchions, 246, 247
- Standard Penetration Test (SPT) blows, 96, 98
- Standards
 - AS 1288, 292
 - BS 4, 209
 - BS 187, 142
 - BS 308, 8
 - BS 449, 79, 261–8, 305, 333, 335
 - BS 1192, 8
 - BS 1202, 304
 - BS 1210, 137, 304, 306
 - BS 1881, 178
 - BS 3692, 305
 - BS 3921, 142
 - BS 4174, 305
 - BS 4183, 306
 - BS 4190, 305
 - BS 4320, 139, 305
 - BS 4360, 249
 - BS 4704, 51
 - BS 5268, 117, 118, 119, 124, 127–34, 136, 138, 140, 147, 155, 159, 333, 336
 - BS 5328, 177, 178, 333, 336
 - BS 5390, 141, 142
 - BS 5449, 212, 214, 216, 218, 220
 - BS 5628, 144, 151, 152–65, 166, 333, 336
 - BS 5930, 92, 95, 332
 - BS 5950, 208, 240, 241, 249–60, 269–74, 281–3, 313, 334, 336
 - BS 5977, 168–9, 333, 336
 - BS 6073, 142
 - BS 6178, 169
 - BS 6180: 1999, 45, 331, 336
 - BS 6206, 285
 - BS 6262, 292
 - BS 6399, 38–40, 43, 44, 130, 331, 336
 - BS 6457, 142
 - BS 8002, 92, 108, 332
 - BS 8004, 92, 100, 332, 336
 - BS 8007, 296, 298, 335
 - BS 8102, 297–8, 335
 - BS 8103, 170
 - BS 8110, 179, 180, 185–203, 296, 334, 336
 - BS 8118, 310–12, 335, 337
 - BS 8298, 141, 142
 - BS 8500, 177
 - BS 8666, 204–5, 334, 337
 - BS EN 207, 177
 - BS EN 336, 119
 - BS EN 1065, 51
 - BS EN 10025, 250
 - BS EN 10034, 210
 - BS EN 10056–2, 210
 - BS EN 10155, 244
 - BS EN 10210, 210
 - BS EN 10279, 210
 - BS EN 20898–1, 139
 - BS EN 22063, 244
 - BS EN ISO 3506, 274
 - BS EN ISO 7519, 8
 - BS EN ISO 8501, 243
 - BS EN ISO 9001, 177
 - BS EN ISO 12944, 242
 - BS EN ISO 14713, 244
 - building regulations, 14–16
 - Common Arrangement of Work Sections for Building Work, 10
 - DIN, 286
 - pr EN 13474, 292, 335
 - Eurocode 5, 117, 334
 - Eurocode 7, 92, 333
 - ISO 9223, 243
 - sampling, 115, 178
 - sieve sizes, 95
 - Static fatigue, 284, 291
 - Static loads, 100
 - Statutory Instruments, 14, 331
 - Steel, 208–74, 334
 - adhesives, 303
 - advantages/disadvantages, 46
 - BS 449, 261–8
 - BS 5950, 208, 240, 241, 248–60
 - composite steel and concrete, 59, 275–83, 334
 - concrete reinforcement, 175, 204, 206
 - connections, 28, 53, 252, 257–60, 266–8, 274
 - corrosion resistance, 179, 241–3, 269, 272, 273
 - ductility, 208, 211, 250, 269, 270
 - durability, 242–4, 272
 - fire resistance, 245, 272, 309
 - floor vibration, 91
 - frames, 42, 276
 - grades, 250, 261–8, 269, 272, 273, 274
 - joist hangers, 169–70
 - lintels, 172–4
 - piles, 102–3, 105
 - plates, 139, 238, 251, 252, 271
 - preliminary sizing, 245–7
 - roof sheeting, 29
 - section classification, 251, 256
 - straps, 28
 - surface preparation, 243–4
 - timber composites, 60
 - trench props, 52
 - trusses, 26
 - see also Galvanized steel; Mild steel; Stainless steel
 - Steel buildings, 29, 31
 - Stiffness
 - aluminium, 309
 - composite sections, 60, 278
 - limit states, 67

- Stiffness – continued
 - reinforced concrete, 191, 195
 - rigid frames, 81–3
 - stainless steel, 270
 - torsion, 88
 - vibration, 91
 - walls, 154
- Stone masonry, 34, 62, 64, 141, 142, 146, 151, 153
- Storage buildings, 30, 38, 40
- Storeys
 - cavity wall panels, 150
 - disproportionate collapse, 28
 - fire resistance, 30
 - lintel design, 168
 - minimum imposed floor loads, 38, 40
 - movement joints, 146
 - rigid frame loading, 82–3
 - slenderness ratio, 155
 - steel elements, 245, 246
- Straightness, 210
- Straps, 28, 170
- Strength
 - composite sections, 60
 - limit states, 61
 - masonry, 141, 142, 144–5, 147, 151, 152–3, 157
 - timber, 62, 117
 - ultimate, 61–3, 66, 151
 - see also Bending strength; Compressive strength; Crushing strength; Flexural strength; Shear strength; Tensile strength
- Stress
 - aluminium, 310
 - beam bending theory, 67
 - combined effects, 256, 265, 268
 - composite sections, 59, 278
 - compressive, 61, 80
 - proof, 61
 - shear, 67, 88, 96
 - strut buckling, 79–80
 - units, 2, 4
 - yield, 61, 80
 - see also Permissible stresses
- Stress/strain curves, 88
- Stressed skin ply panels, 27, 46, 125
- Strip foundations, 93, 101
- Structural analysis, 55–91, 332
 - sign conventions, 65
- Structural forms, 25, 26–8
- Structural glass, 284–94
- Structural movement joints, 29, 146
- Structural steel, 208–74
- Struts, 79–80, 255
- Studs, 132, 275, 278, 281, 283
- Subcontractors, 6–7, 10
- Subframes, 82, 189, 196
- Sulphate resisting mortar, 147
- Supports
 - beam bending, 69–78
 - composite beams, 282, 283
 - concrete beams, 185, 191, 277
 - glass, 291, 293
 - lintels, 168–9, 171–4
 - panels, 161, 162–4
 - plates, 84–5
 - slabs, 188, 189, 300
 - vibration, 91
 - walls, 148, 155, 162–4
- Surface preparation, 243–4, 298, 301–2
- Surface rafts, 93
- Surveyors, 21–3
- Suspension, 27
- Tarmac, 143, 171, 299, 329, 336
- Taut wires, 89
- Technical drawings, 6, 8–9, 11–12, 24, 119
- Technical Standards 1990, 15
- Temperature
 - adhesives, 301
 - aluminium, 309, 311, 312
 - brickwork, 306
 - concreting, 306
 - fire effects, 307–8
 - fungal attack, 122
 - glass, 282, 283
 - movement joints, 29, 146, 298
 - steel, 249, 250
 - units, 4
- Tempered glass, 284, 285, 286, 287, 292, 293
- Temporary works toolkit, 51–3
- Tender documentation, 6–7, 12, 24
- Tendons, 309
- Tensile strength, 61–3, 170, 176, 209, 270, 273, 274, 286
- Tensile stresses
 - bolted connections, 258–60, 268, 305
 - cast iron, 208
 - glass, 284, 291, 294
 - masonry, 141, 151, 160, 161
 - reinforced concrete, 186, 191–2, 203
 - sign conventions, 66
 - steel, 261, 265, 271
 - timber, 128, 129, 130
- Tension capacity, 258–60, 266, 268, 282
- Tension chords, 53, 89–90, 245
- Tension cracks, 107, 108
- Tension members, 132, 252
- Terzaghi's equation, 101
- Testing
 - Charpy notch test, 250
 - concrete cube testing, 177, 178
 - glass, 284, 291, 293
 - site investigation, 12, 94
 - Standard Penetration Test, 96, 98
 - stone, 151
 - triaxial tests, 97
- Thermal conductivity, 124
- Thermal expansion, 64, 144, 146, 176, 209, 270, 286, 310
- Thermal shock, 284, 285
- Thermal spraying, 244
- Thickness, 34–7
 - aluminium, 311
 - glass, 287, 289–90, 293
 - masonry, 148, 149, 151, 154, 155, 156

- mild steel sections, 212–35, 239, 245, 250, 251, 261–5, 268
- reinforced concrete, 180–1, 276
- span/thickness ratios, 148
- stainless steel, 270
- timber elements, 121, 125, 130
- Thin walled sections, 88
- Timber, 10, 34, 117–40, 333
 - adhesives, 302, 303
 - advantages/disadvantages, 46
 - BS 5268, 117, 118, 119, 124, 127–34, 136, 138, 140
 - composite sections, 59
 - durability, 122–3
 - fire resistance, 124, 309
 - flat roof loadings, 41
 - flitched, 27
 - floor loadings, 41
 - frames, 42
 - fungal attack, 122
 - grade stresses, 128–9, 130, 132, 133, 140
 - historical use, 32
 - insect attack, 123
 - joints, 53, 135–40, 304, 305, 306
 - joists, 46, 125, 126
 - moisture content, 118, 122, 128
 - piles, 105
 - pitched roof loadings, 41
 - preliminary sizing, 125–6
 - properties, 62, 64, 65, 118
 - screws, 303, 304, 305
 - seasoning, 118
 - section sizes, 119–21
 - shear strength, 62
 - shrinkage, 118
 - span/depth ratios, 125
 - strength classes, 117, 128, 130, 136
 - tolerances, 31, 119
 - tongued and grooved, 126
 - trusses, 26, 132
 - wane, 128
 - weathering, 122
- Timber products, 117, 122
- Time
 - units, 1
- Toe radius, 218, 222, 224
- Tolerances, 31, 106, 119, 210–11, 265, 291
- Toolkit, 52–4
- Torque, 66, 88, 286, 291
- Torsion, 28, 88, 128, 213–35, 239, 240, 241, 253
- Total stresses, 96
- Toughened glass, 284, 285, 286, 287, 289, 290, 291, 292, 293
- Toughness, 208, 270
- Town and Country Planning Act 1990, 13
- Town and Country Planning Act (Scotland) 1997, 13
- Toxicity
 - contaminated land, 113–16
- Trade contractors *see* Subcontractors
- Transportation, 48–51, 291
- Transverse forces, 257, 271
- Tree Protection Orders (TPOs), 18
- Trees
 - root action, 92, 94, 109–12
 - water demand, 109–12
- Triangles, 314–15
- Triaxial tests, 97
- Trigger values, 115, 116
- Trigonometric relationships, 5, 313
- Trusses, 26, 132, 245, 246, 277
- Tubes, 88, 311
- Turning circle of vehicles, 49–50
- Twist, 210, 239
- Ultimate bending strength, 117, 253–4
- Ultimate capacity, 84, 186
- Ultimate limit state (ULS), 66, 185
- Ultimate loads, 67, 125, 273, 274, 281, 289
- Ultimate strengths, 60–2, 66, 151, 182, 273, 274
- Undrained soils, 96–8
- Unfactored loads, 92, 127, 195, 278, 292
- Uniform moment of area, 77
- Unit beams, 54
- Unit load, 34–7
- Unit strengths, 142
- Units
 - conversion factors, 4, 5
 - imperial system, 3, 4, 5
 - metric system, 1–2, 4, 5
 - prefixes, 1
- Universal beams (UB), 210, 212–15, 251, 253, 277
- Universal columns (UC), 210, 216–17, 245, 251, 253, 277
- VAT for listed buildings, 17
- Vaults, 167
- Vehicle loading, 48–51
- Veneers, 117, 120–1
- Vermiculite concrete spray, 245
- Vertical cantilever columns, 28
- Vertical deflection limits, 68, 81
- Vertical joints, 146
- Vertical loads, 148, 149, 153, 156, 298
- Verticality, 31, 52
- Vibration, 91, 278, 279, 281
- Volume
 - units, 2, 3, 4
- Wales *see* England and Wales
- Wall studs, 132
- Walls
 - bearing pressure, 165
 - bending moment coefficients, 162–4
 - cavity, 146, 148, 150, 159, 172–4, 295, 296, 298
 - compressive strength, 153, 156, 160
 - damp proofing, 295
 - diagrams, 27
 - flexural strength, 160–1, 295
 - freestanding, 161
 - glass, 290
 - load resistance, 155, 156
 - mortar, 144
 - movement joints, 146

- Walls – continued
 - party walls, 21–3
 - reinforced concrete, 180, 206
 - stiffness, 154
 - strapping, 170
 - tolerances, 31
 - verticality, 31
 - waterproofing, 295, 296, 298, 299
 - see also Retaining walls
- Warehouses, 40
- Warping, 213, 215, 217, 219, 221
- Washers, 139, 305
- Water
 - absorption by masonry, 141, 142, 147
 - concrete mixes, 175, 176, 177, 179, 307
 - ingress to glass, 288
 - pressure, 152, 185, 249, 296
 - tree water demand, 109–12
- Waterproofing, 29, 147, 177, 295–9
- Weathering, 95, 122, 147, 179, 244, 272
- Webs
 - composite steel and concrete, 278, 281, 282, 283
 - plywood stress skin panels, 125
 - steel sections, 212, 214, 216, 218, 220, 226–32, 251, 252, 262, 265
- Weight
 - aluminium, 310
 - building materials, 34–7
 - bulk, 96, 97, 98
 - composite steel and concrete, 279–80
 - dry, 96
 - glass, 284, 290, 291
 - hollowcore slabs, 300
 - lintels, 168, 172–4
 - mild steel sections, 236–8
 - plywood, 130
 - reinforcement bars, 182
 - units, 2, 3
 - vehicles and loads, 47–51
- Welding
 - aluminium, 311
 - composite steel and concrete, 275
 - connections, 252, 257, 266, 306
 - stainless steel, 269, 272, 273, 274
- Wet rot, 122
- White Papers, 13
- Width
 - lintels, 171–4
 - steel sections, 210, 212, 214, 216, 218, 220, 251
 - vehicles and loads, 50–1
- Wind loading, 43
 - aluminium, 312
 - code CP3, 43
 - glass, 284, 290
 - masonry, 148, 152, 158, 159, 170, 307
 - reinforced concrete, 185
 - steel, 239, 249, 261
 - timber, 133
 - units, 2
- Wires, 89, 183, 304
- Wood see Timber
- Work hardening, 208, 211, 310
- Work sections, 10
- Working spaces, 93
- Wrought iron, 32, 61, 63, 208

- Yield line analysis, 84–7, 161
- Yield strength, 208, 309
- Yield stress, 61, 80, 211
- Young's modulus of elasticity, 60, 67, 273, 294

- Zero Environment Ltd, 113, 330
- Zinc coatings, 244, 308